



Mitsubishi Safety Programmable Controller

MELSEC **QS** series

CC-Link Safety System Master Module User's Manual

-QS0J61BT12



● SAFETY PRECAUTIONS ●

(Always read these instructions before using this equipment.)

Before using the product, please read this manual, the relevant manuals introduced in this manual, standard PLC manuals, and the safety standards carefully and pay full attention to safety to handle the product correctly.

In this manual, the safety instructions are ranked as " WARNING" and " CAUTION".



Indicates that incorrect handling may cause hazardous conditions, resulting in death or severe injury.



Indicates that incorrect handling may cause hazardous conditions, resulting in minor or moderate injury or property damage.

Note that the  CAUTION level may lead to a serious consequence according to the circumstances. Always follow the instructions of both levels because they are important to personal safety.

Please save this manual to make it accessible when required and always forward it to the end user.

[Design Precautions]

WARNING

- When a safety PLC detects an error in an external power supply or a failure in PLC main module, it turns off all the outputs.
Create an external circuit to securely stop the power of hazard by turning off the outputs. Incorrect configuration may result in an accident.
- Create short current protection for a safety relay, and a protection circuit such as a fuse, and breaker, outside a safety PLC.
- When a safety remote I/O module has detected a CC-Link Safety error, it turns off all the outputs.
Note that the outputs in a sequence program are not automatically turned off.
If a CC-Link Safety error has been detected, create a sequence program that turns off the outputs in the program.
If the CC-Link Safety is restored with the outputs on, it may suddenly operate and result in an accident.
- To inhibit restart without manual operation after safety functions was performed and outputs were turned OFF, create an interlock program which uses a reset button for restart.

CAUTION

- Do not bunch the wires of external devices or communication cables together with the main circuit or power lines, or install them close to each other.
They should be installed 100 mm (3.94 inch) or more from each other.
Not doing so could result in noise that would cause erroneous operation.

[Installation Precautions]



CAUTION

- Use a safety PLC in the environment that meets the general specifications described in the QSCPU User's Manual (Hardware Design, Maintenance and Inspection). Using this PLC in an environment outside the range of the general specifications could result in electric shock, fire, erroneous operation, and damage to or deterioration of the product

- While pressing the installation lever located at the bottom of module, insert the module fixing tab into the fixing hole in the base unit until it stops. Then, securely mount the module with the fixing hole as a supporting point.
Incorrect loading of the module can cause a failure or drop.
Secure the module to the base unit with screws.
Tighten the screw in the specified torque range.
If the screws are too loose, it may cause a drop of the screw or module. Overtightening may cause a drop due to the damage of the screw or module.

- Completely turn off the externally supplied power used in the system before mounting or removing the module. Not doing so could result in damage to the product.

- Do not directly touch the module's conductive parts or electronic components.
Doing so may cause malfunctions or a failure.

[Wiring Precautions]



WARNING

- Be sure to shut off all phases of the external supply power used by the system before wiring. Not completely turning off all power could result in electric shock or damage to the product.

- When energizing or operating the module after installation or wiring, be sure to close the attached terminal cover.
Not doing so may result in electric shock.

[Wiring Precautions]

CAUTION

- Tighten a terminal block mounting screw, terminal screw, and module mounting screw within the specified torque range.
If the terminal block mounting screw or terminal screw is too loose, it may cause a short circuit, fire, or malfunctions.
If too tight, it may damage the screw and/or the module, resulting in a drop of the screw or module, a short circuit or malfunctions.
If the module mounting screw is too loose, it may cause a drop of the screw or module.
Overtightening the screw may cause a drop due to the damage of the screw or module.

- Be sure there are no foreign substances such as sawdust or wiring debris inside the module. Such debris could cause a fire, failure, or malfunctions.

- The module has an ingress prevention label on its top to prevent foreign matter, such as wire offcuts, from entering the module during wiring.
Do not peel this label during wiring.
Before starting system operation, be sure to peel this label because of heat dissipat.

- Be sure to fix the communication cables or power cables by ducts or clamps when connecting them to the module.
Failure to do so may cause damage of the module or cables due to a wobble, unintentional shifting, or accidental pull of the cables, or malfunctions due to poor contact of the cable.

- When removing the connected communication cables or power cables, do not pull the cable with grasping the cable part.
Remove the cable connected to the terminal block after loosening the terminal block screws.
Pulling the cable connected to a module may result in malfunctions or damage of the module or cable.

- For the cables to be used in the CC-Link Safety system, use the ones specified by the manufacturer.
Otherwise, the performance of the CC-Link Safety system is not guaranteed.
As to the maximum overall cable length and station - to station cable length, follow the specifications described in the CC-Link Safety System Master Module User's Manual.
If not following the specification, the normal data transmission is not guaranteed.

[Startup and Maintenance precautions]



WARNING

- Do not touch the terminals while power is on. Doing so could cause shock or erroneous operation.
- Turn off all phases of the external supply power used in the system when cleaning the module or retightening the terminal block mounting screws, terminal screws, or module mounting screws. Not doing so could result in electric shock.
Tighten a terminal block mounting screw, terminal screw, and module mounting screw within the specified torque range.
If the terminal block mounting screw or terminal screw is too loose, it may cause a short circuit, fire, or malfunctions.
If too tight, it may damage the screw and/or the module, resulting in a drop of the screw or module, a short circuit or malfunctions.
If the module mounting screw is too loose, it may cause a drop of the screw or module.
Overtightening the screw may cause a drop due to the damage of the screw or module.



CAUTION

- Do not disassemble or modify the modules.
Doing so could cause a failure, malfunctions, injury, or fire.
If the product is repaired or remodeled by other than the specified FA centers or us, the warranty is not covered.
- Completely turn off the externally supplied power used in the system before mounting or removing the module.
Not doing so may result in a failure or malfunctions of the module.
- Restrict the mounting/removal of a module, base unit, and terminal block up to 50 times (IEC61131-2-compliant), after the first use of the product.
Failure to do so may cause the module to malfunction due to poor contact of connector.
- Before touching the module, always touch grounded metal, etc. to discharge static electricity from human body, etc.
Not doing so may result in a failure or malfunctions of the module.

[Disposal Precautions]



CAUTION

- When disposing of this product, treat it as industrial waste.

● CONDITIONS OF USE FOR THE PRODUCT ●

- (1) Although MELCO has obtained the certification for Product's compliance to the international safety standards IEC61508, EN954-1/ISO13849-1 from TUV Rheinland, this fact does not guarantee that Product will be free from any malfunction or failure. The user of this Product shall comply with any and all applicable safety standard, regulation or law and take appropriate safety measures for the system in which the Product is installed or used and shall take the second or third safety measures other than the Product. MELCO is not liable for damages that could have been prevented by compliance with any applicable safety standard, regulation or law.

- (2) MELCO prohibits the use of Products with or in any application involving, and MELCO shall not be liable for a default, a liability for defect warranty, a quality assurance, negligence or other tort and a product liability in these applications.
 - (a) power plants,
 - (b) trains, railway systems, airplanes, airline operations, other transportation systems,
 - (c) hospitals, medical care, dialysis and life support facilities or equipment,
 - (d) amusement equipments,
 - (e) incineration and fuel devices,
 - (f) handling of nuclear or hazardous materials or chemicals,
 - (g) mining and drilling,
 - (h) and other applications where the level of risk to human life, health or property are elevated.

REVISIONS

The manual number is given on the bottom left of the back cover.

Print Date	Manual Number	Revision
Sep., 2006	SH(NA)-080600ENG-A	First edition
Dec., 2006	SH(NA)-080600ENG-B	Partial correction Appendix 1
Apr., 2008	SH(NA)-080600ENG-C	Partial correction ABOUT MANUALS, Section 1.3, 2.1, 3.1, 4.1, 5.2.1, 5.2.2, 5.2.3, 5.3, 6.2, 6.3.1, 7.7.2, 9.1, 9.2.2, 9.3.1 Addition Appendix 2
Jun., 2010	SH(NA)-080600ENG-D	Partial correction SAFETY PRECAUTIONS, Chapter 1 Addition CONDITIONS OF USE FOR THE PRODUCT, Section 2.2.2

Japanese Manual Version SH-080599-C

This manual confers no industrial property rights or any rights of any other kind, nor does it confer any patent licenses. Mitsubishi Electric Corporation cannot be held responsible for any problems involving industrial property rights which may occur as a result of using the contents noted in this manual.

INTRODUCTION

Thank you for purchasing the Mitsubishi safety programmable controller MELSEC-QS series.

Before using the equipment, please read this manual carefully to develop full familiarity with the functions and performance of the QS series PLC you have purchased, so as to ensure correct use.

CONTENTS

SAFETY PRECAUTIONS.....	A - 1
CONDITIONS OF USE FOR THE PRODUCT.....	A - 6
REVISIONS.....	A - 7
INTRODUCTION	A - 8
CONTENTS.....	A - 8
ABOUT MANUALS	A - 11
COMPLIANCE WITH THE EMC, LOW VOLTAGE, AND MACHINERY DIRECTIVES	A - 12
About the Generic Terms and Abbreviations.....	A - 13
Product Components.....	A - 15

CHAPTER1 OVERVIEW 1 - 1 to 1 - 2

1.1 Overview.....	1 - 1
1.2 Compatibility with CC-Link	1 - 2
1.3 Features	1 - 2

CHAPTER2 SYSTEM CONFIGURATION 2 - 1 to 2 - 3

2.1 System Configuration	2 - 1
2.2 Applicable System	2 - 2
2.2.1 Applicable modules and number of mountable modules	2 - 2
2.2.2 How to check the function version	2 - 3
2.2.3 Module Replacement	2 - 3

CHAPTER3 SPECIFICATIONS 3 - 1 to 3 - 3

3.1 Performance Specifications.....	3 - 1
3.1.1 Maximum overall cable distance (for Ver. 1.10).....	3 - 2
3.1.2 Maximum overall cable distance (for Ver. 1.00).....	3 - 2
3.2 CC-Link Dedicated Cable	3 - 3

CHAPTER4 FUNCTIONS 4 - 1 to 4 - 31

4.1 Function List	4 - 1
4.2 Detailed Explanation of Functions	4 - 3
4.2.1 Communication with safety remote I/O stations	4 - 3
4.2.2 Communication across a network composed of safety remote stations and standard remote stations	4 - 6
4.2.3 Auto refresh function.....	4 - 9
4.2.4 Identifying the communication target station (remote I/O station)	4 - 12

4.2.5	Station number overlap checking function	4 - 17
4.2.6	Slave station cut-off function	4 - 18
4.2.7	Automatic return function	4 - 20
4.2.8	Data link stop function at safety CPU error	4 - 21
4.2.9	Clearing inputs from data link faulty stations.....	4 - 22
4.2.10	Slave station forced clear function at safety CPU stop	4 - 23
4.2.11	Error history registration function.....	4 - 25
4.2.12	Reserved station function.....	4 - 26
4.2.13	Scan synchronization function	4 - 27
4.2.14	Safety remote station interlock function.....	4 - 30

CHAPTER5 DATA LINK PROCESSING TIME AND STATION STATUS AT ERROR OCCURRENCE **5 - 1 to 5 - 23**

5.1	Link Scan Time	5 - 1
5.2	Transmission Delay Time	5 - 3
5.2.1	Safety master station Safety remote I/O station	5 - 3
5.2.2	Safety master station Standard remote I/O station	5 - 11
5.2.3	Safety master station Remote device station	5 - 15
5.3	Auto Refresh Time.....	5 - 19
5.4	Station Status at Error Occurrence.....	5 - 21

CHAPTER6 PARAMETER SETTING **6 - 1 to 6 - 9**

6.1	Procedure for Parameter Setting and Data Link Startup	6 - 1
6.2	Parameter Setting Items.....	6 - 2
6.3	Parameter Setting Example.....	6 - 4
6.3.1	Safety master station network parameter setting	6 - 4

CHAPTER7 PROCEDURE BEFORE STARTING DATA LINK **7 - 1 to 7 - 14**

7.1	Procedures before System Operation	7 - 1
7.2	Module Installation Procedure.....	7 - 2
7.3	Mounting and Installation	7 - 3
7.3.1	Handling Precautions.....	7 - 3
7.3.2	Installation Environment	7 - 5
7.4	Part Names and Settings.....	7 - 6
7.5	Checking the Module Status (Hardware Test)	7 - 8
7.6	CC-Link Dedicated Cable Wiring	7 - 10
7.7	T-Branch Connection with the CC-Link Dedicated Cable	7 - 11
7.7.1	T-Branch system configuration	7 - 11
7.7.2	T-Branch communication specifications list.....	7 - 12
7.8	Checking the Connection Status (Line Test)	7 - 13

CHAPTER8 PROGRAMMING SPECIFICATIONS**8 - 1 to 8 - 27**

8.1	I/O Signals used for Safety CPU Module.....	8 - 2
8.1.1	I/O signal list.....	8 - 2
8.1.2	Details of input signals	8 - 3
8.2	Buffer Memory.....	8 - 5
8.2.1	Buffer memory list.....	8 - 5
8.2.2	Buffer memory details	8 - 6
8.3	Link Special Relays and Registers (SB/SW)	8 - 17
8.3.1	Link special relays (SB)	8 - 17
8.3.2	Link special registers (SW).....	8 - 20

CHAPTER9 TROUBLESHOOTING**9 - 1 to 9 - 32**

9.1	Checking the Condition by Each Problem	9 - 1
9.2	Check with LEDs (1) - at System Start-up	9 - 10
9.2.1	When "RUN" LED on the safety master module does not turn ON with "POWER" LED on the safety power supply module being ON	9 - 10
9.2.2	When "ERR." LED on the safety master module turns ON or flashes with "RUN" LED on the safety master module being ON	9 - 11
9.2.3	When receiving inputs or outputting data from a remote station is not possible despite "ERR." LED OFF status of the safety master module.....	9 - 15
9.3	Check with LEDs (2) - During System Operation	9 - 16
9.3.1	When "ERR." LED on the safety master module turns ON or flashes with "RUN" LED on the safety master module being ON	9 - 16
9.3.2	When receiving inputs or outputting data from a remote station is not possible with "ERR." LED on the safety master module being OFF.....	9 - 19
9.3.3	When "RUN" LED on the safety master module turns OFF suddenly	9 - 20
9.4	CC-Link Diagnostics Using GX Developer	9 - 21
9.5	Error Codes	9 - 27

APPENDIX**App- 1 to App - 3**

Appendix 1	External Dimensions Diagram	App- 1
Appendix 2	Transmission Delay Time when Module whose Serial Number (First Five Digits) is "10031" or Earlier is Included.....	App- 2

INDEX**Index- 1 to Index- 1**

ABOUT MANUALS

Before constructing or designing the safety-related system, be sure to read the following manual.

Introduction manual

Manual Name	Manual Number (Model Code)
Safety Application Guide Explains the overview, construction method, laying and wiring examples, and application programs of the safety-related system. (Sold separately)	SH-080613ENG (13JR90)

Related manuals

Manual Name	Manual Number (Model Code)
CC-Link Safety System Remote I/O Module User's Manual Explains the specifications, procedures and settings before system operation, parameter setting, and troubleshooting of the CC-Link Safety system remote I/O module. (Sold separately)	SH-080612ENG (13JR89)
QSCPU User's Manual (Hardware Design, Maintenance and Inspection) Explains the specifications of the QSCPU, safety power supply module, safety base unit and others. (Sold separately)	SH-080626ENG (13JR92)
QSCPU User's Manual (Function Explanation, Program Fundamentals) Explains the functions, programming methods, devices and others. that are necessary to create programs with the QSCPU. (Sold separately)	SH-080627ENG (13JR93)
QSCPU Programming Manual (Common Instructions) Explains how to use the sequence instructions, basic instructions, application instructions, and QSCPU dedicated instructions. (Sold separately)	SH-080628ENG (13JW01)
GX Developer Version 8 Operating Manual Explains the online functions of GX Developer, such as the programming, printout, monitoring, and debugging methods. (Sold separately)	SH-080373E (13JU41)
GX Developer Version8 Operating Manual (Safety PLC)(Safety Programmable Controller) Explains the GX Developer functions added and modified for the compatibility with the safety programmable controller. (Sold separately)	SH-080576ENG (13JU53)

Remark

Printed materials are separately available for single item purchase. Order the manual by quoting the manual number on the table above (Model code).

COMPLIANCE WITH THE EMC, LOW VOLTAGE, AND MACHINERY DIRECTIVES

To configure a system meeting the requirements of the EMC, Low Voltage, and Machinery Directives when incorporating the Mitsubishi programmable controller (EMC, Low Voltage, and Machinery Directives compliant) into other machinery or equipment, refer to the userAfs manual for the CPU module used.

The CE mark, indicating compliance with the EMC, Low Voltage, and Machinery Directives, is printed on the rating plate of the programmable controller.

ABOUT THE GENERIC TERMS AND ABBREVIATIONS

This manual uses the following generic terms and abbreviations to describe the QS0J61BT12 CC-Link Safety system master module, unless otherwise specified.

Generic Term/ Abbreviation	Description
PLC	Abbreviation for Programmable Controller.
Safety PLC	General name for safety CPU module, safety power supply module, safety main base unit, CC-Link safety master module and CC-Link safety remote I/O module.
Standard PLC	General name of each module for MELSEC-Q series, MELSEC-QnA series, MELSEC-A series and MELSEC-FX series. (Used for distinction from safety PLC.)
QS0J61BT12	Abbreviation for QS0J61BT12 CC-Link Safety System Master Module
Safety master module	Other name for QS0J61BT12.
Standard master module	General name for CC-Link system master modules
Safety CPU module	Abbreviation for QS001CPU type safety CPU module.
Cyclic transmission	Transmission method to periodically communicate the contents of remote I/O and remote registers.
Safety master station	Station which controls the CC-Link Safety system. One station is required per system.
Safety remote I/O station	Remote station which handles only the information in bit units. Compatible with the safety communications.
Standard remote I/O station	Remote station which handles only the information in bit units. Not compatible with the safety communications.
Remote I/O station	General name for safety remote I/O station and standard remote I/O station
Remote device station	Remote station which handles information in both bit and word units. Not compatible with the safety communications.
Safety remote station	Other name for safety remote I/O station
Standard remote station	General name for standard remote I/O station and remote device station
Remote station	General name for safety remote I/O station, standard remote I/O station and remote device station. They are controlled by the safety master station.
Slave station	General name for safety remote I/O station, standard remote I/O station and remote device station
SB	Link special relay (for CC-Link safety system) Bit information that indicates the module operating status and data link status of the master station. (Expressed as SB for convenience)
SW	Link special register (for CC-Link safety system) 16-bit information that indicates the module operating status and data link status of the master station. (Expressed as SW for convenience)
RX	Remote input (for CC-Link safety system) Information entered in bit units from the remote station to the master station. (Expressed as RX for convenience)
RY	Remote output (for CC-Link safety system) Information output in bit units from the master station to the remote station. (Expressed as RY for convenience)
RWw	Remote register (Write area for CC-Link safety system) Information output in 16-bit units from the master station to the remote device station. (Expressed as RWw for convenience)

Generic Term/ Abbreviation	Description
RWr	Remote register (Read area for CC-Link safety system) Information entered in 16-bit units from the remote device station to the master station. (Expressed as RWr for convenience)
GX Developer	General product name for the models, SW8D5C-GPPW, SW8D5C-GPPW-A, SW8D5C-GPPW-V and SW8D5C-GPPW-VA.

PRODUCT COMPONENTS

The components of the QS0J61BT12 are listed below.

Item name	Quantity
QS0J61BT12 main unit	1
Terminating resistor 110 Ω , 1/2 W (brown-brown-brown) (used when wiring with the Version 1.10 compatible CC-Link dedicated cable or CC-Link dedicated cable)	2

CHAPTER1 OVERVIEW

This manual describes the specifications, part names and settings of the QS0J61BT12 CC-Link Safety system master module (hereinafter referred to as the QS0J61BT12) which is used with the MELSEC-QS series programmable controller CPUs.

When applying the following program examples to the actual system, make sure to examine the applicability and confirm that it will not cause system control problems.

Product Name	Model	Description
CC-Link Safety system master module	QS0J61BT12	A module which is mounted on a safety main base unit and establishes connection to CC-Link Safety
	QS0J61BT12-K	An S-mark ^{*1} certified CC-Link Safety system master module

1.1 Overview

The CC-Link Safety system is a network system for which the communication error detection function of the CC-Link system has been enhanced, and thus it can be applied to the cases where safety is required in machine controls.

1.2 Compatibility with CC-Link

This product supports the following CC-Link functions and performance.

- Cyclic transmission
- Less restrictions on the station-to-station cable length
- CC-Link Safety

1.3 Features

The CC-Link Safety system and the QS0J61BT12 feature the following.

(1) Safety network system of the highest level

The CC-Link Safety system is a safety network system which has obtained the highest safety level (EN954-1 Category 4, ISO13849-1 PL e, IEC61508 SIL3) applicable to programmable controllers. This allows easy construction of safety network system with high safety.

(2) Communication possible in a network comprising safety remote stations and standard remote stations

Safety remote stations and standard remote stations can be installed together on the same network. Safety I/O devices such as emergency stop buttons, light curtains and safety relays can be installed together with standard I/O devices such as start buttons, reset buttons and indicators on the same network.

(3) Safety remote station parameter setting function

With GX Developer, safety remote station parameters can be set easily.

(4) Identifying the communication target station (remote I/O station)

By presetting the model name and production information of a safety remote station in network parameter setting, safety remote stations different from the setting can be detected when connected.

(5) Error history registration function

Error information received from safety remote stations and the one occurred during communication with safety remote stations are registered to the error history in the safety CPU.

Use GX Developer to read such error history information, making troubleshooting easy for the CC-Link Safety system and safety remote stations.

CHAPTER2 SYSTEM CONFIGURATION

The system configuration for the CC-Link Safety system is described below.

2.1 System Configuration

Up to 64 stations in total of safety remote I/O stations, standard remote I/O stations and remote device stations can be connected to a single safety master station. However, the following conditions must all be satisfied.

Condition 1	$\{(1 \times a) + \{(2 \times b) + \{(3 \times c) + \{(4 \times d)\} = 64$	a: Number of modules occupying 1 station b: Number of modules occupying 2 stations c: Number of modules occupying 3 stations d: Number of modules occupying 4 stations
Condition 2	$A \leq 64$ $B + C \leq 42$ $\{(16 \times A) + \{(54 \times (B + C))\} \leq 2304$	A: Number of standard remote I/O stations B: Number of remote device stations C: Number of safety remote I/O stations

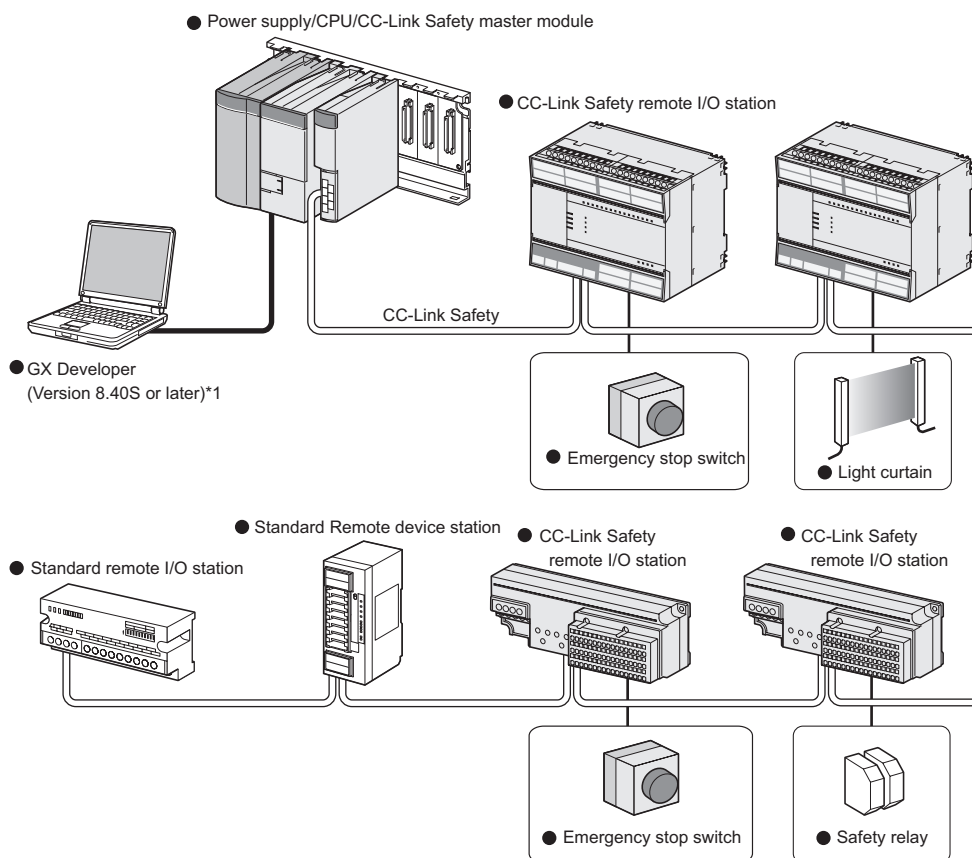

* 1 : The available functions vary depending on the version. For details, refer to the following manual.

QSCPU User's Manual(Function Explanation,Program Fundamentals)

2.2 Applicable System

This section explains applicable PLC CPU models and the number of mountable modules.

2.2.1 Applicable modules and number of mountable modules

(1) Applicable modules and number of mountable modules

The CPU module for which the QS0J61BT12 can be mounted and its mountable number are listed in the table below.

Applicable module		Number of mountable modules	Remark
Safety CPU module	QS001CPU	Up to 2	

(2) Applicable base unit

The QS0J61BT12 can be mounted in any I/O slot of a safety main base unit.

Product name	Model name	Remarks
Safety main base unit	QS034B	

(3) Applicable software package

The software package available for the QS0J61BT12 is listed below:

Product name	Model name	Remarks
GX Developer	SWnD5C-GPPW*1	Required MELSEC PLC programming software. "n" in the model name is 8 or greater.

* 1 Product in version 8.40S or later is required.

(4) Usable slave stations

Slave station types supported by the QS0J61BT12 are listed below.

Remote station type			○:Connectable ×:Not connectable
Safety	Remote I/O station		○
Standard	Remote I/O station	Ver.1-compatible	○
		Ver.2-compatible	×
	Remote device station	Ver.1-compatible	○
		Ver.2-compatible	×
	Intelligent device station	Ver.1-compatible	×
		Ver.2-compatible	×
	Local station	Ver.1-compatible	×
		Ver.2-compatible	×
Standby master station	Ver.1-compatible	×	
	Ver.2-compatible	×	

2.2.2 How to check the function version

The following shows how to check the function version.

(1) How to check the function version of the QS0J61BT12

(a) Checking the "SERIAL" of the rating plate on the module side

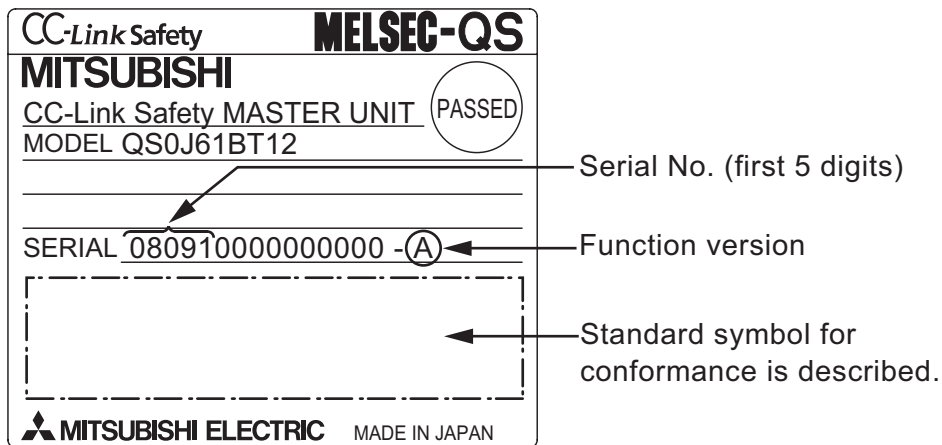

(b) See Section 9.4 for how to check the function version with GX Developer.

2.2.3 Module Replacement

Replace the module according to the following replacement cycle.

Module	Replacement Cycle
CC-Link Safety system master module	10 years

CHAPTER3 SPECIFICATIONS

This section describes the specifications of the QS0J61BT12.

3.1 Performance Specifications

Table3.1 shows the performance specifications of the QS0J61BT12.

Refer to the User's Manual of the CPU for the general specifications of the QS0J61BT12.

Table3.1 Performance Specifications

Item		Specifications				
Transmission rate		Select from 156kbps/625kbps/2.5Mbps/5Mbps/10Mbps				
Maximum overall cable distance (Maximum transmission distance)		Differs according to transmission rate (Refer to Section 3.1.1)				
Maximum No. of connectable modules		64 modules				
Maximum No. of link points per system		Remote I/O (RX, RY): 2048 points Remote register (RW _r): 256 points (remote device station → master station) Remote register (RW _w): 256 points (master station → remote device station)				
Link points per remote station	Station type	Safety remote station	Standard remote station			
	Number of occupied stations	1 station	1 station	2 stations	3 stations	4 stations
	RX	32 points	32 points	64 points	96 points	128 points
	RY	32 points	32 points	64 points	96 points	128 points
	RW _r	0 points	4 points	8 points	12 points	16 points
	RW _w	0 points	4 points	8 points	12 points	16 points
Communication method		Broadcast polling method				
Synchronization method		Flag synchronous system				
Coding method		NRZI method				
Transmission path		Bus (RS-485)				
Transmission format		HDLC compliant				
Error control system		CRC32 ^{*2} $(X^{32}+X^{26}+X^{23}+X^{22}+X^{16}+X^{12}+X^{11}+X^{10}+X^8+X^7+X^5+X^4+X^2+X+1)$				
		CRC16 $(X^{16}+X^{12}+X^5+1)$				
Recommended connection cable		Version 1.10 compatible CC-Link dedicated cable ^{*1}				
No. of I/O occupied points		32 points (I/O assignment: 32 intelligent points)				
5V DC internal current consumption		0.46A				
Weight		0.12kg				

* 1 CC-Link dedicated cable (Ver.1.00) or CC-Link dedicated high-performance cable can be also used. Using a cable together with another type of cable is not allowed. Attach terminating resistors which match the cable type.(Refer to Section 7.6)

* 2 Error detection using CRC32 is not performed for communication with standard remote I/O stations or remote device stations.

3.1.1 Maximum overall cable distance (for Ver. 1.10)

The relation of the transmission speed and maximum overall cable distance when configuring the entire system with Version 1.10 modules and cable is shown below.

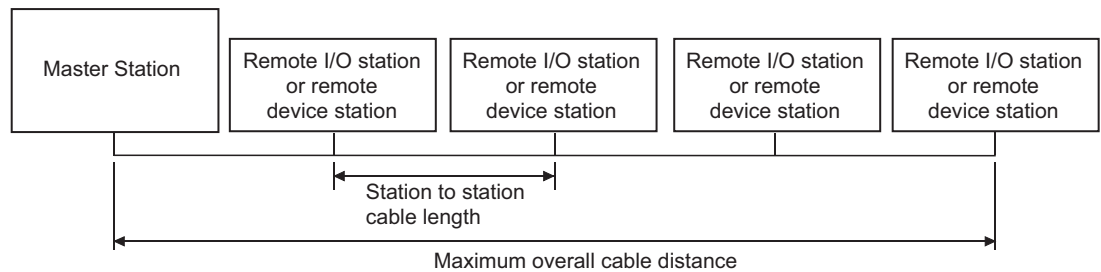

Version 1.10 compatible CC-Link dedicated cable (terminating resistor of 110W used)

Transmission Speed	Station to station cable length	Maximum overall cable distance
156kbps	20cm or longer	1200m
625kbps		900m
2.5Mbps		400m
5Mbps		160m
10Mbps		100m

3.1.2 Maximum overall cable distance (for Ver. 1.00)

For the relation between the transmission rate and the maximum overall cable distance, refer to the following:

CC-Link Partner Association website: <http://www.cc-link.org/>

3.2 CC-Link Dedicated Cable

Use CC-Link dedicated cables in the CC-Link Safety systems.
Performance of the CC-Link Safety system cannot be guaranteed if any cables other than CC-Link dedicated cables are used.
For the specifications and any inquiries on the CC-Link dedicated cables, refer to the following:
CC-Link Partner Association website: <http://www.cc-link.org/>

Remark

For details, refer to the CC-Link Cable Wiring Manual issued by the CC-Link Partner Association.
.....

CHAPTER4 FUNCTIONS

This chapter explains the functions of the QS0J61BT12.

4.1 Function List

Table4.1 below lists the functions.

Table4.1 Function list (1/2)

Item	Description	Reference section
Communication with safety remote I/O stations	Performs on/off data communication with safety remote I/O stations.	Section 4.2.1
Communication across a network composed of safety and standard remote stations	Exchanges ON/OFF information and numerical data across a network composed of both safety remote stations and standard remote stations.	Section 4.2.2
Automatic refresh function	Refreshes devices (RX/Ry/RWr/RWw) on CC-Link Safety to/from any devices on the safety CPU, based on the setting in GX Developer.	Section 4.2.3
Identifying the communication target station (remote I/O station)	Identifies the safety remote station connected, judging whether or not it is the correct one.	Section 4.2.4
Station number overlap checking function	Checks for overlapping in number of occupied stations of remote stations, and whether more than one master station (station No. 0) exist in the system or not.	Section 4.2.5
Slave station cut-off function	Disconnects the module that cannot continue the data link because of power off, and continues the data link among normal modules only.	Section 4.2.6
Automatic return function	When a module, which has been disconnected from the data link because of power off, returns to the normal status, it automatically joins the data link.	Section 4.2.7
Data link stop function at safety CPU error	Stops the data link when a stop error occurred on the safety CPU module.	Section 4.2.8
Clearing inputs from data link faulty stations	Clears input (received) data from a station where a data link error occurred due to power-off, etc.	Section 4.2.9
Slave station forced clear function at safety CPU stop	Forcibly clears output data to slave stations when the safety CPU stops.	Section 4.2.10
Error history registration function	Transfers error information that is generated on safety remote stations and CC-Link Safety to the safety CPU, and registers the information as error history.	Section 4.2.11
Reserved station function	By assigning modules that will be connected in the future as reserved stations, they will not be treated as data link faulty stations.	Section 4.2.12

Table 4.1 Function list (2/2)

Item	Description	Reference section
Scan synchronization function	Synchronous mode: Performs link scan in synchronization with sequence scan. Asynchronous mode: Performs link scan not in synchronization with sequence scan.	Section 4.2.13
Safety remote station interlock function	When a communication error occurs between a safety master station and a safety remote station, this function prevents automatic restart of input and output from the relevant safety remote station(s).	Section 4.2.14

4.2 Detailed Explanation of Functions

This section provides detailed explanation on the functions of the QS0J61BT12.

4.2.1 Communication with safety remote I/O stations

The QS0J61BT12 exchanges ON/OFF data of safety components (e.g. emergency stop buttons, light curtains) and safety relays connected to safety remote I/O stations using its remote input (RX) and remote output (RY).

Remote stations can be connected in any order, and their station number can also be set in any order.

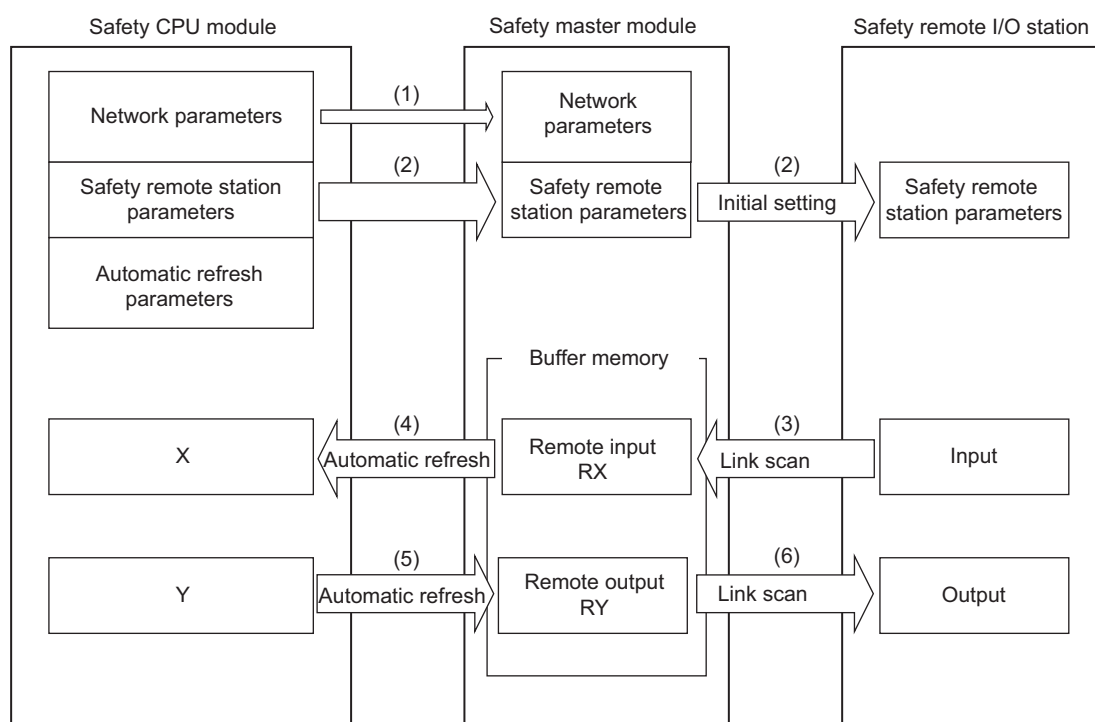

[Data link startup]

- (1) After the safety PLC system is powered on, network parameters in the safety CPU module are transferred to the safety master module, and then a data link is started up.
- (2) The safety master module sends "safety remote station parameters", which are stored in the safety CPU module, to the linked safety remote I/O stations. The safety remote I/O stations start I/O operations upon reception of the "safety remote station parameters".

[Remote input]

- (3) The safety master module reads input status data of safety remote I/O stations, and saves them in its remote input (RX) area.
- (4) The safety CPU module saves the remote input (RX) data of the safety master module to the CPU device that is specified with the auto refresh parameter. This is performed in the END processing of the sequence scan.

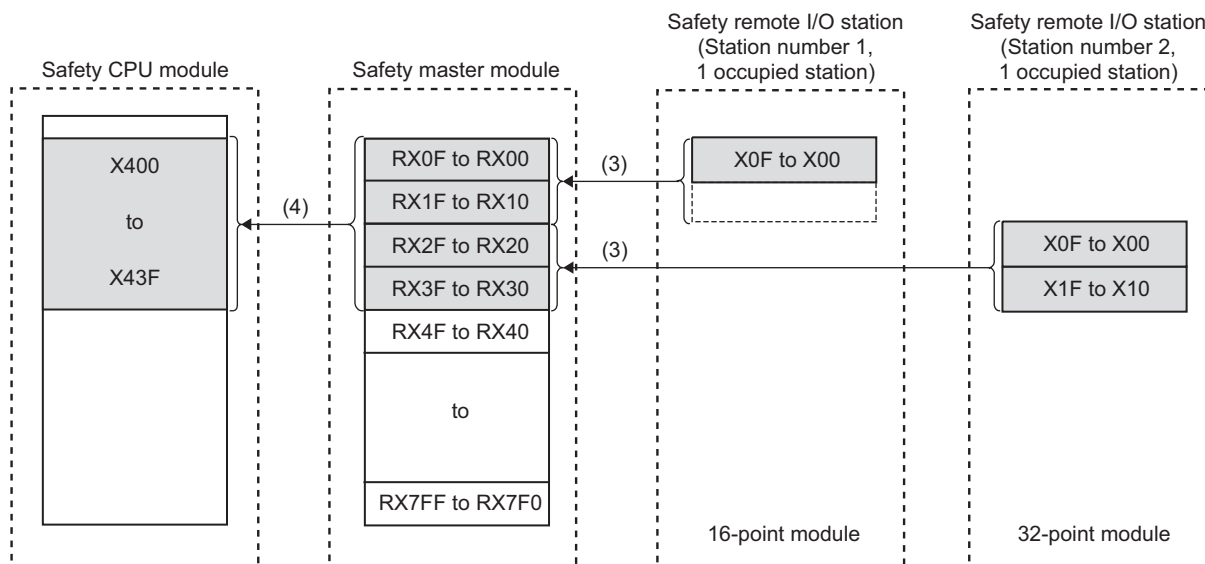

[Remote output]

- (5) The safety CPU module saves the CPU device value set by the auto refresh parameter into the remote output (RY) area of the safety master module. This is performed in the END processing of the sequence scan.
- (6) The safety master module sends the remote output (RY) values to safety remote I/O stations.

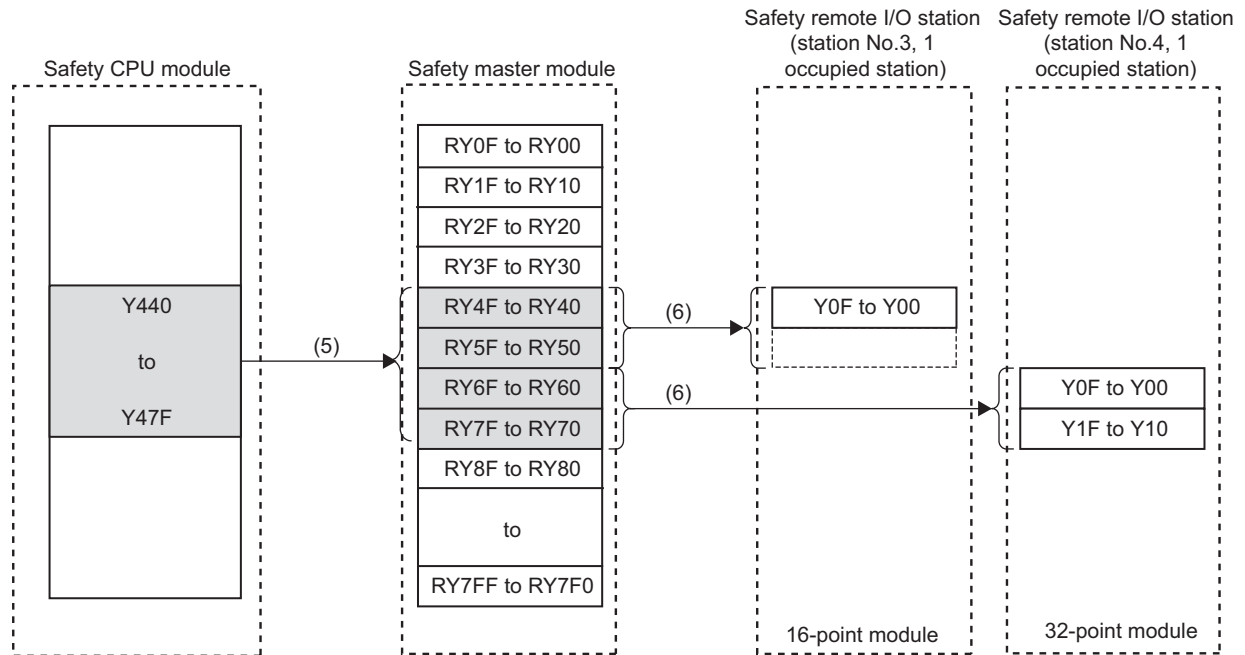

POINT

In remote registers RWw and RWr of safety remote I/O stations, the system uses 4 words per station. The automatic refresh setting is not necessary for them.

4.2.2 Communication across a network composed of safety remote stations and standard remote stations

The following is a simplified figure showing how communication is performed when safety remote stations and standard remote stations are connected on the same network. When these remote stations are connected together on the same network, there are no restrictions on the order of connections and station numbers.

POINT

Before creating a program for a network where both safety remote stations and standard remote stations are installed, refer to the programming precautions explained in Safety Application Guide.

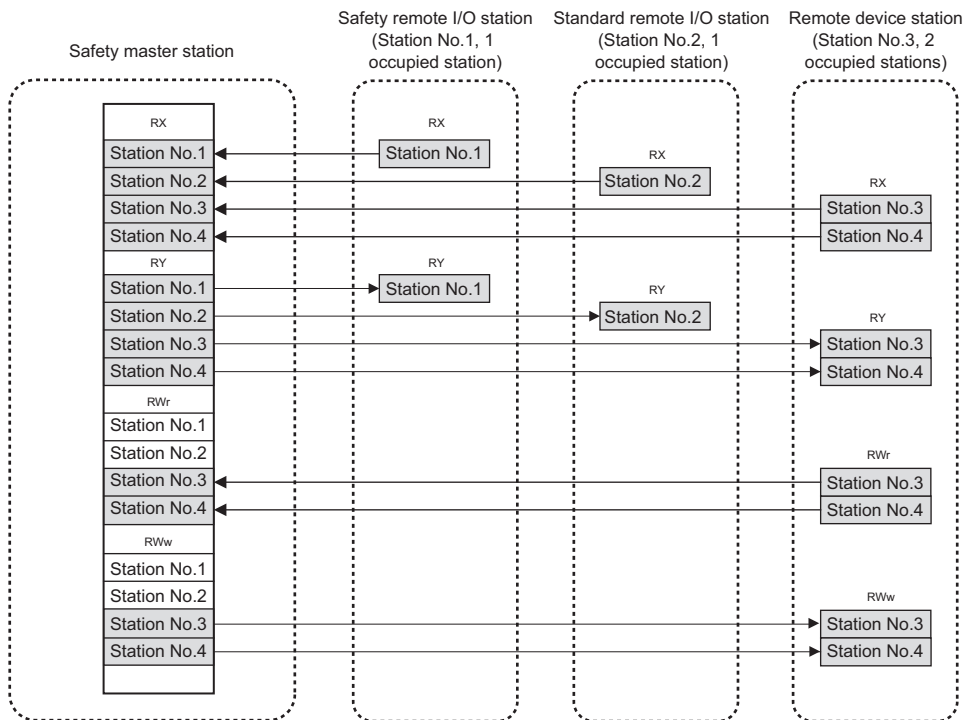
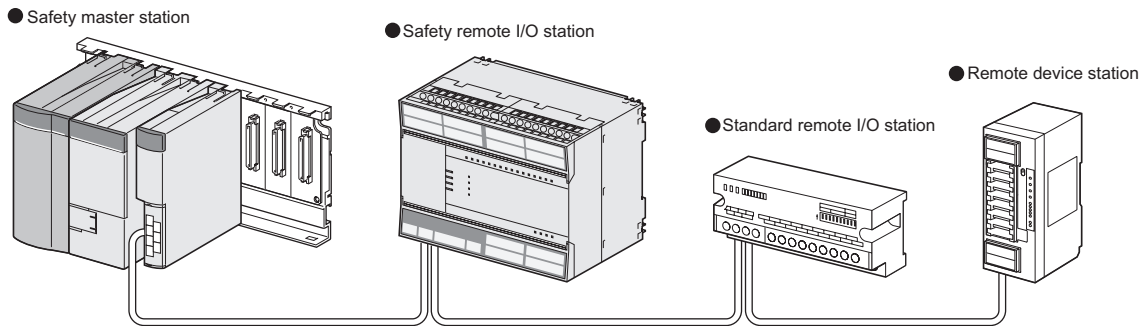

[Remote input, Remote register (RWr)]

Data in remote input (RX) and remote register (RWr) areas of remote stations are stored into the safety master station.

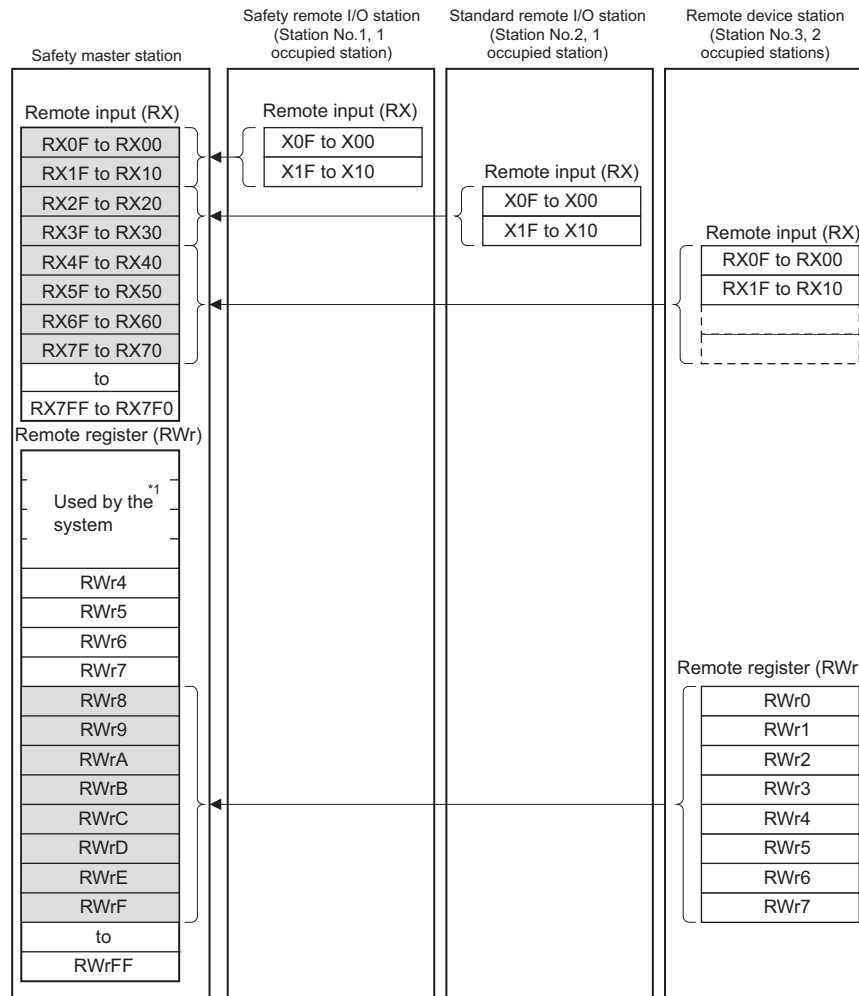

* 1 On a safety remote I/O station, 4 points of RWr are used by the system.

[Remote output, Remote register (RWw)]

Data in remote output (RY) and remote register (RWw) areas of the safety master station are sent to respective remote stations.

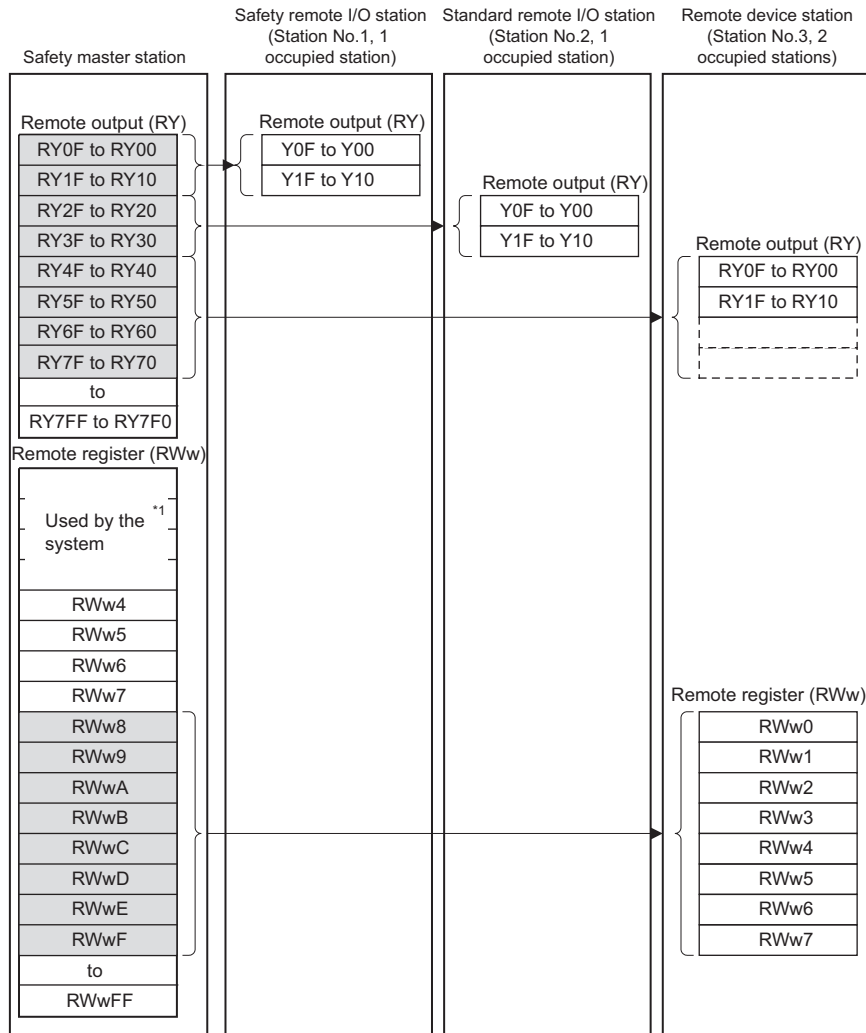

* 1 On a safety remote I/O station, 4 points of RWw are used by the system.

4.2.3 Auto refresh function

With this function, data in the following devices are refreshed all together to the devices of the safety CPU module when it executes END processing: remote input (RX), remote output (RY) and remote registers (RW_r, RW_w) of remote stations, and link special relay (SB) and like special register (SW) of the safety master module.

(1) Settable devices

Devices settable for the auto refresh function are as follows:

Table4.2 Devices settable for auto refresh ○: Settable, -: Not settable

Buffer memory	Bit device						Word device					
	X	Y	M	B	F	SB	D	W	T	ST	C	SW
Remote input (RX)	○	-	○	○	-	-	○	○	-	-	-	-
Remote output (RY)	-	○	○	○	-	-	○	○	○	○	○	-
Remote register (RW _r)	-	-	○	○	-	-	○	○	-	-	-	-
Remote register (RW _w)	-	-	○	○	-	-	○	○	○	○	○	-
Link special relay (SB)	-	-	○	○	-	○	○	○	-	-	-	-
Link special register (SW)	-	-	○	○	-	-	○	○	-	-	-	○

(2) Operation in auto refresh

When the auto refresh parameters are set, the relation between the CPU devices and the refresh-target devices (remote input (RX), remote output (RY), remote registers (RW_r, RW_w), link special relay (SB) and like special register (SW)) is as shown on the system configuration example below.

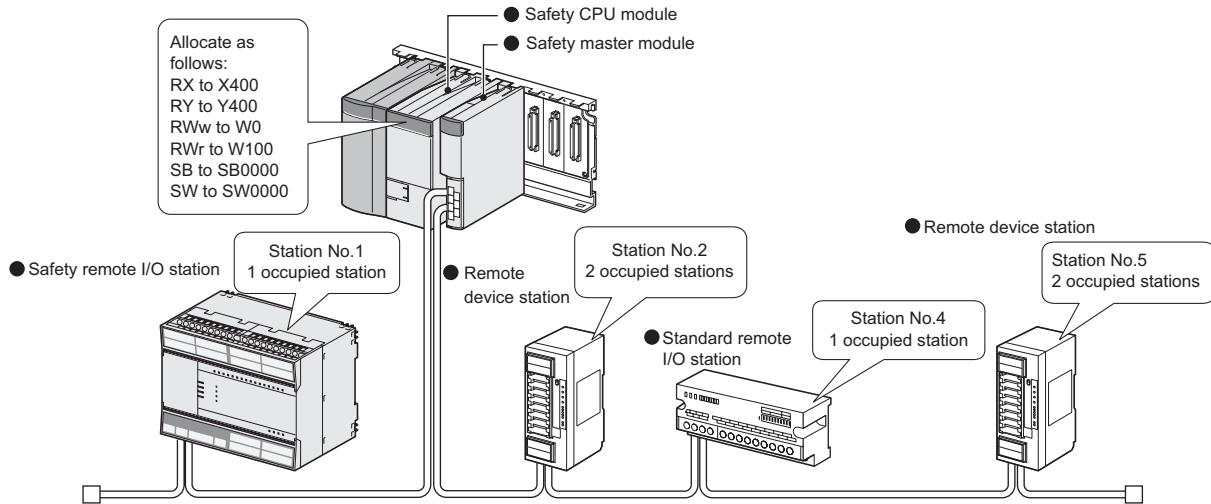

The relation between the CPU devices and the devices of each remote station is as shown below. Note that this figure is illustrated based on the following setting: remote input (RX) is set to X400, remote output (RY) is set to Y400, remote registers (RW_r, RW_w) are set to W0 and W100 respectively, link special relay (SB) is set to SB0000 and link special register (SW) is set to SW0000.

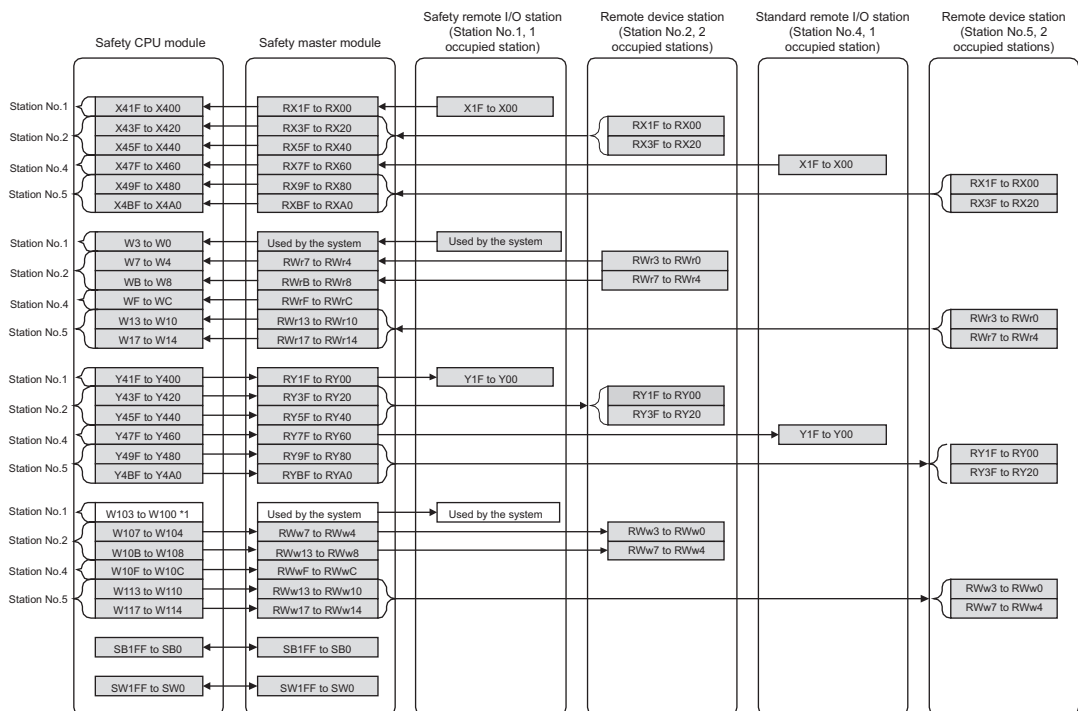

*1: The CPU devices assigned to RW_w of safety remote I/O stations are not refreshed automatically.

(3) Precautions for setting the automatic refresh parameters

The following are precautions for setting the automatic refresh parameters.

- 1) On each of safety remote I/O stations, 4 words in the remote register (RW_r, RW_w) areas are used by the system.
- 2) When the automatic refresh setting is not made for remote input (RX), remote output (RY), remote register (RW_r, RW_w), link special relay (SB), and link special register (SW), the resulting operation is shown in "Table4.3 When the automatic refresh setting is not made".

Table4.3 When the automatic refresh setting is not made

	Safety remote station			Standard remote station		
	Data output to remote station	Read/write from sequence program	Read/write from GX Developer	Data output to remote station	Read/write from sequence program	Read/write from GX Developer
Remote input (RX)	–	Read/write not allowed *3	Read/write allowed	–	Read/write not allowed *3	Read/write allowed
Remote output (RY)	0*1			0*2		
Remote register (RW _r)	–			–		
Remote register (RW _w)	0*1			0*2		
Link special relay (SB)	–			–		
Link special register (SW)	–			–		

* 1: Forced output to slave stations using GX Developer is also not allowed.

* 2: Forced output to slave stations using GX Developer is allowed.

* 3: To read or write data from the sequence program, perform the automatic refresh setting.

[Setting method]

For the specification of automatic refresh parameters, refer to CHAPTER 6

4.2.4 Identifying the communication target station (remote I/O station)

This function determines whether a safety remote station is properly connected or not. Standard remote stations are not identified by this function.

The following shows the identification methods of the safety master station and the ranges allowable for respective methods.

- (1) Identification by link ID
- (2) Identification by product model name
- (3) Identification by module technical version
- (4) Identification by production information

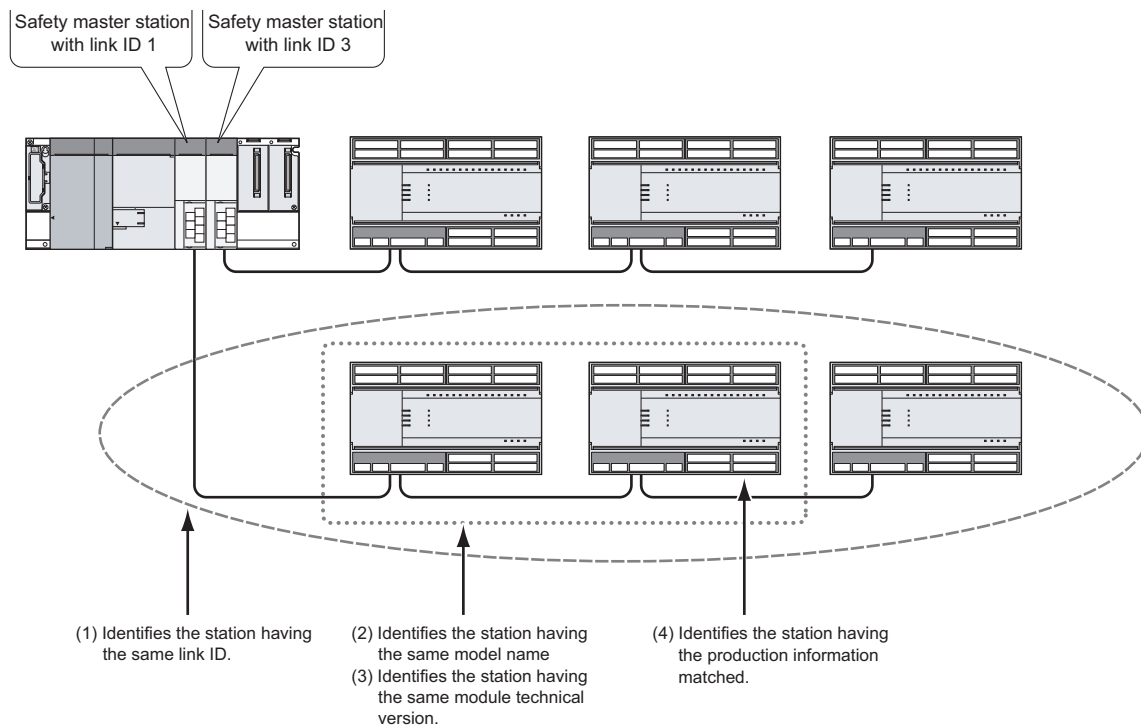

(1) Identifying a safety remote station by link ID

Whether the link ID set in a safety master station matches the one set in a safety remote station or not is determined.

By using this function, a mistake in connection with the master station can be found. When these link IDs do not match, CC-LINK RECEIVED DATA ERROR (Error code 8332) is saved in the error history of the safety CPU module on the safety master station.

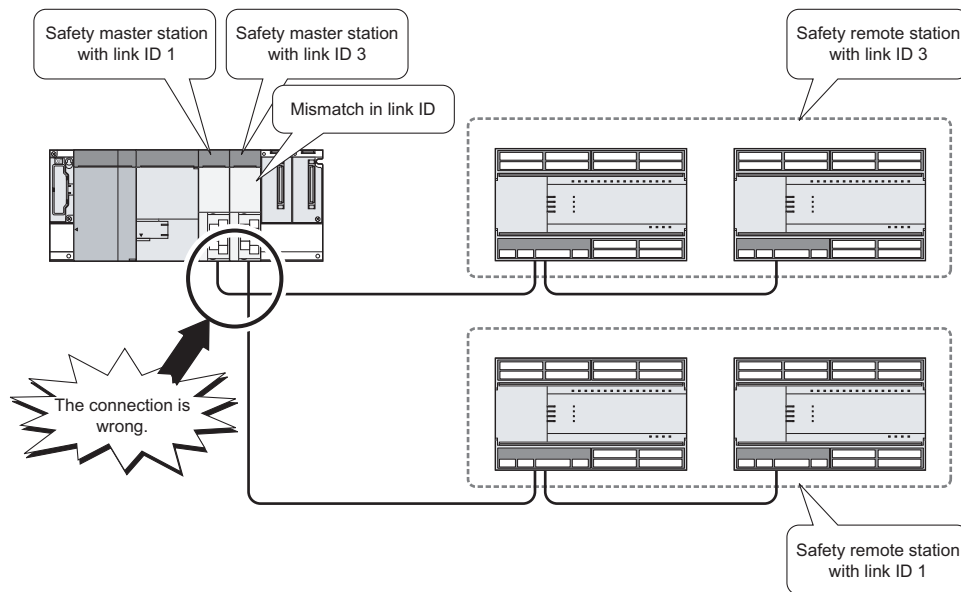

(2) Identifying a safety remote station by product model name

Whether the name of the model mounted on a safety remote station matches the one set with a network parameter or not is determined.

If they do not match, CC-LINK PRODUCT INFO. MISMATCH (Error code 8310) is saved in the error history of the safety CPU module.

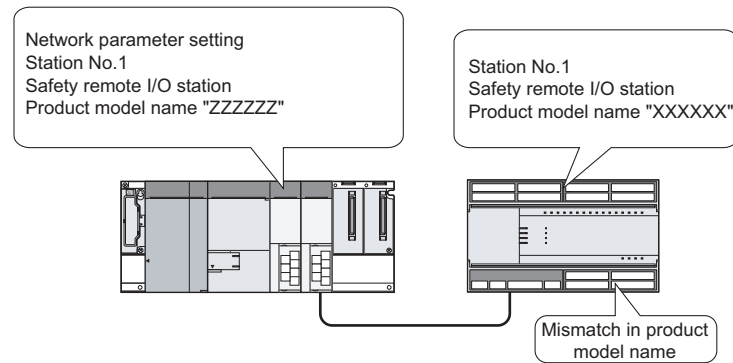

(3) Identifying a safety remote station by module technical version

Whether the module technical version of the model mounted on a safety remote station matches the one selected for the network parameter or not is determined. If they do not match, CC-LINK PRODUCT INFO. MISMATCH (Error code 8310) is saved in the error history of the safety CPU module.

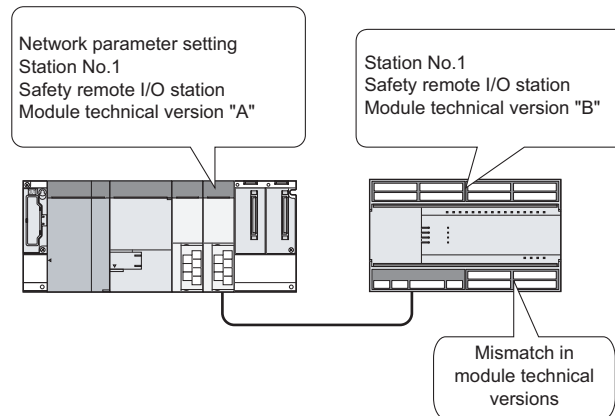

(4) Identifying a safety remote station by production information

When product information has been specified in the network parameter setting, whether it matches the actual one or not is determined.

If the product information set in the network parameter setting does not match that of the actual safety remote station, CC-LINK PRODUCT INFO. MISMATCH (Error code 8310) is saved in the error history of the safety CPU module.

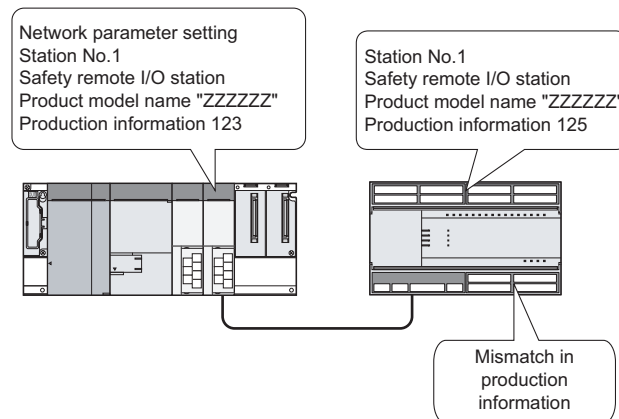

[Setting method]

For the specification of link ID, product model name, module technical version, or product information, refer to CHAPTER 6.

4.2.5 Station number overlap checking function

This function checks the status of the remote stations connected to the safety master station to check if there is duplication in occupied station numbers and if more than one station have station number 0 in the system.

(1) Checking for occupied station number overlap

When the PLC is powered OFF and then ON or when data link is started due to reset cancellation of the safety CPU module, this function checks remote stations for any duplication in occupied station numbers.

(Example) There is duplication in occupied station numbers.

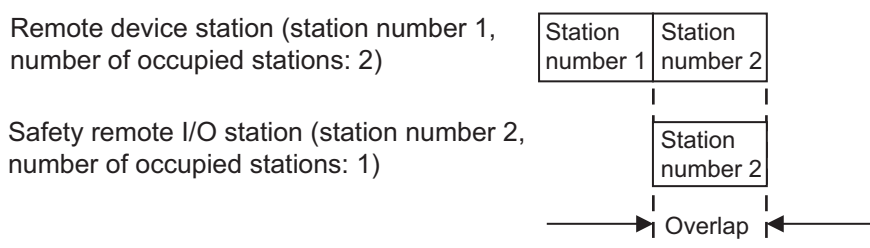

- 1) When duplication is detected, the "ERR." LED on the safety master module flashes, and the status of the detected duplication is stored to SW0098 to SW009B (station No. duplication status).
- 2) Even if an overlap exists, the safety master station continues the data link with the remaining normally functioning stations.
- 3) Correct the station number setting of the remote station and reset the PLC CPU on the safety master station. Doing so will turn off the "ERR." LED on the safety master module, clearing the data stored in SW0098 to SW009B.

(2) Checking for duplication of station number 0

When the PLC is powered OFF and then ON or when data link is started due to reset cancellation of the safety CPU module, this function checks if any other master station (station number set to 0) exists on the same network and is performing communication.

- 1) When duplication is detected, the "ERR." LED on the safety master module turns ON, and an error code is stored to SW006A (switch setting status), turning ON SB006A (switch setting status).
- 2) Reducing the safety master stations to one and resetting its PLC CPU will turn off the "ERR." LED and clear the data of SW006A.

4.2.6 Slave station cut-off function

When a remote station becomes incapable of continuing data link due to a reason such as power-off or a safety monitoring timeout error, this function disconnects that remote station only, allowing the other normal stations to continue the data link.

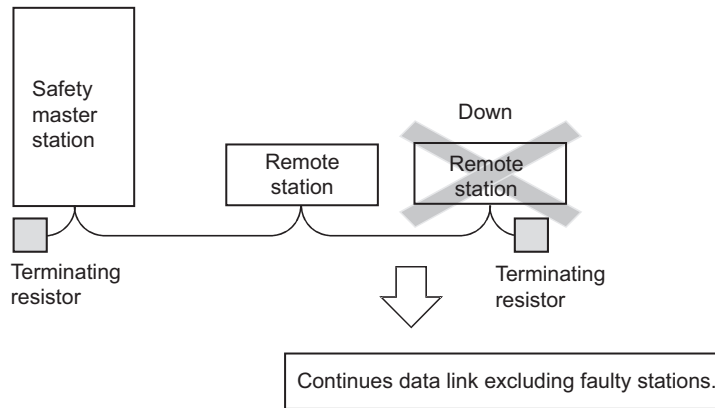

[About the safety monitoring timeout error]

If no signal has been normally received from a safety remote station for the period of the safety refresh monitoring time or longer, a safety monitoring timeout error is detected. If this occurs, the safety master station disconnects only the relevant safety remote station, and CC-LINK DATA RECEPTION TIMEOUT (Error code 8320 to 8329) is stored in the error history of the safety CPU module.

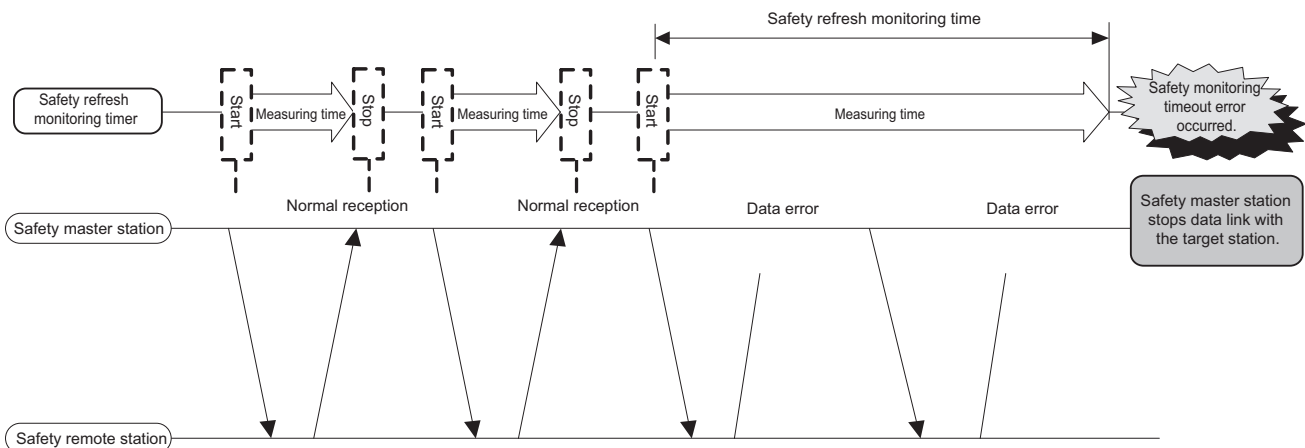

POINT

In the event of cable disconnection, the data link cannot be performed because there is no terminating resistor. (The "ERR." LED on the safety master module turns ON.)

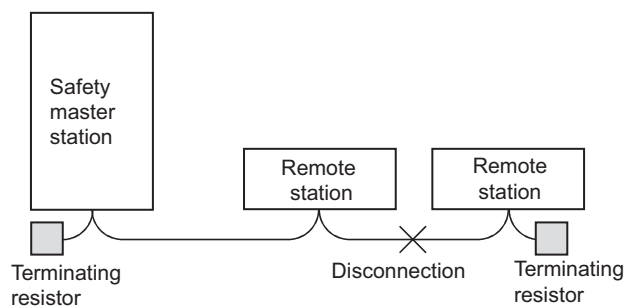

4.2.7 Automatic return function

This function allows remote stations that have been disconnected from the data link due to a cause such as power-off to automatically reconnect to the data link when they return to the normal status.

[Setting method]

Set the "Automatic reconnection station count" value in the network parameters on the GX Developer. For more details on the setting, see Section 6.3.

4.2.8 Data link stop function at safety CPU error

This function stops the data link when "an error that stops operation" occurred on the PLC CPU of the safety master station.

4.2.9 Clearing inputs from data link faulty stations

The safety master station clears (turns OFF) input data (RX) received from a remote station that has a data link error.

Note that remote register (RWr) data is held.

(1) Input (received) data that are cleared

The following figure shows the target buffer memory areas.

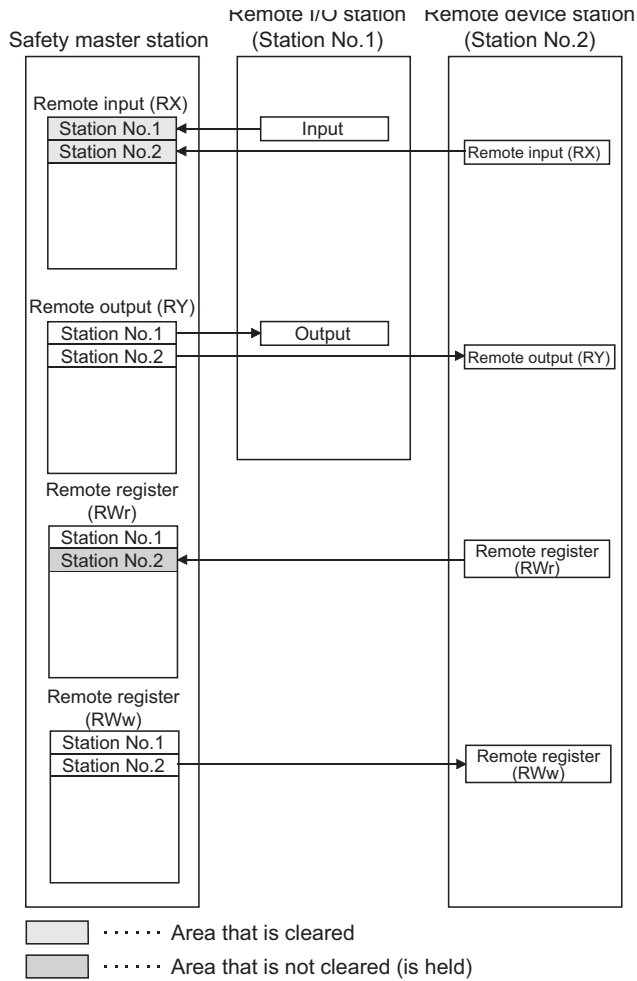

4.2.10 Slave station forced clear function at safety CPU stop

This function forcibly clears the remote output (RY) to slave stations when the safety CPU module is stopped.

The following is applied depending on the remote output (RY) refresh device setting of the automatic refresh parameter.

- When "Y" is specified, the remote output (RY) turns off regardless of the parameter setting.
- When "any other than Y (e.g. M)" is specified, whether to clear the remote output (RY) forcibly or not can be selected with a parameter. (The parameter setting is effective only when the safety CPU is in TEST mode. In SAFETY mode or in the wait-for-restart-SAFETY state, the remote output (RY) is forcibly cleared regardless of the parameter setting.)

The figure below shows the target buffer memory areas.

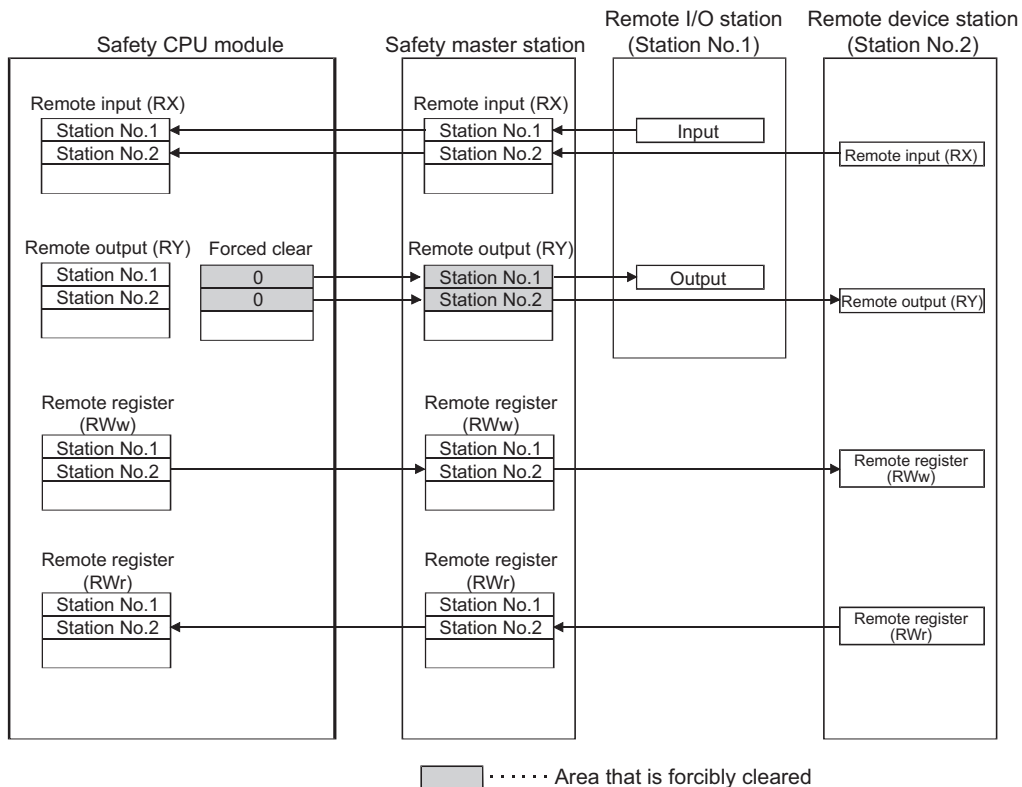

The forced clear of slave stations in case of safety CPU stop works on the remote output (RY). It does not function on remote input (RX), remote register (RWw) and remote register (RWr).

POINT

Specifying the forced clear disables the forced output to slave stations by GX Developer when the safety CPU module stops.

[Setting method]

In GX Developer, make setting in "Operational setting" of the network parameter and in "Case of CPU STOP setting".

For more details on the setting, see Section 6.3.

4.2.11 Error history registration function

When a moderate error (causing I/O stop) occurs at a safety remote station, or when a communication fault occurs between a safety master station and a safety remote station, the error information is saved in the safety CPU module as an error log.

(1) When a moderate error occurred on a safety remote station

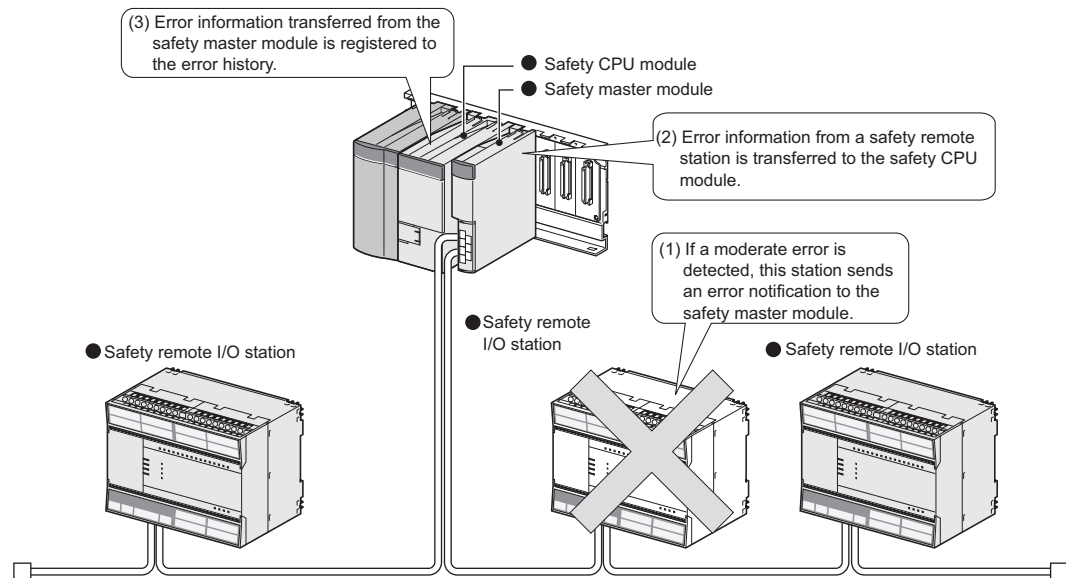

(2) When a communication error occurred between the safety master station and safety remote stations

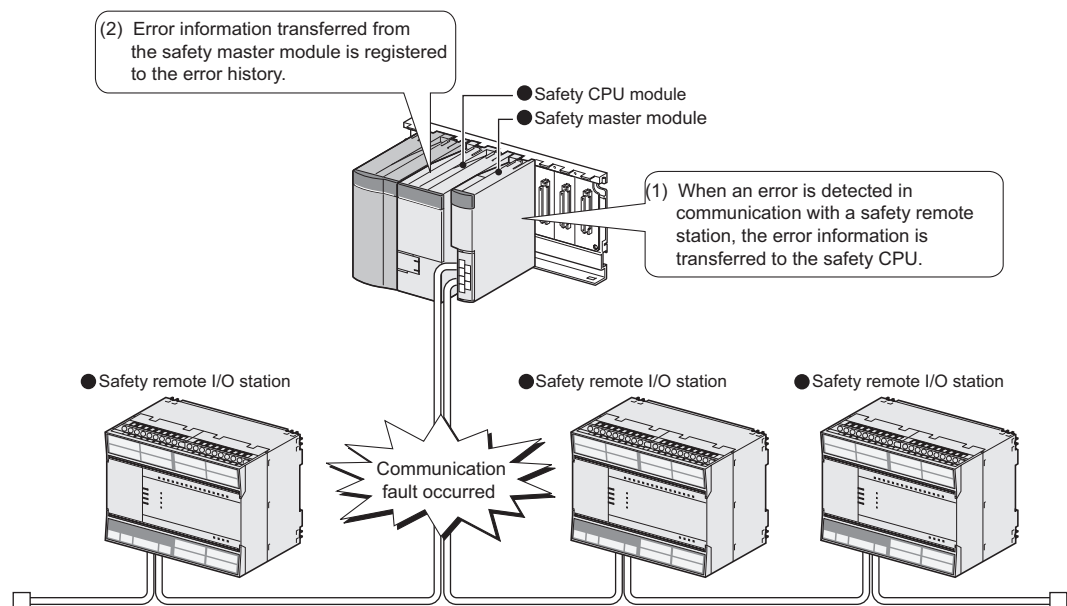

4.2.12 Reserved station function

This function prevents safety remote I/O stations, standard remote I/O stations and remote device stations that are not connected (that will be connected in the future) from being treated as "Data link faulty station" by the safety master station.

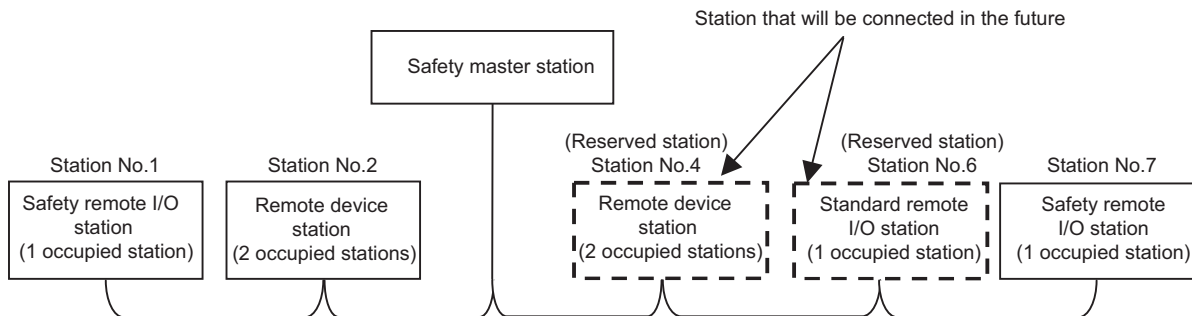

POINT

When any of safety remote I/O stations, standard remote I/O stations and remote device stations that are already connected is specified as a reserved station, the data link with the specified station is disabled.

[Setting method]

Set reserved stations in "Station information setting" of the network parameters using the GX Developer.

For more details on the setting, see Section 6.3.

4.2.13 Scan synchronization function

Whether to make the link scan synchronized with the sequence scan or not is selected.

[Synchronous mode]

Link scan is synchronized with sequence scan. Therefore longer sequence scan causes longer link scan interval.

IMPORTANT

The sequence scan time must not exceed the time given in the listed below. If the scan time exceeds the limit, a time out error occurs at each station.

Transmission rate	Sequence scan time
156kbps	800ms
625kbps	400ms
2.5Mbps	100ms
5Mbps	50ms
10Mbps	50ms

If the sequence scan time exceeds the above-listed value, reduce the transmission rate or change the mode to Asynchronous mode.

Especially, when using 10Mbps or 5Mbps, the sequence scan time may exceeds 50ms due to instantaneous power failure of the master station. Therefore, take preventive measures using external devices such as a UPS (Uninterruptible Power Supply).

Data flow in the synchronous mode is shown below.

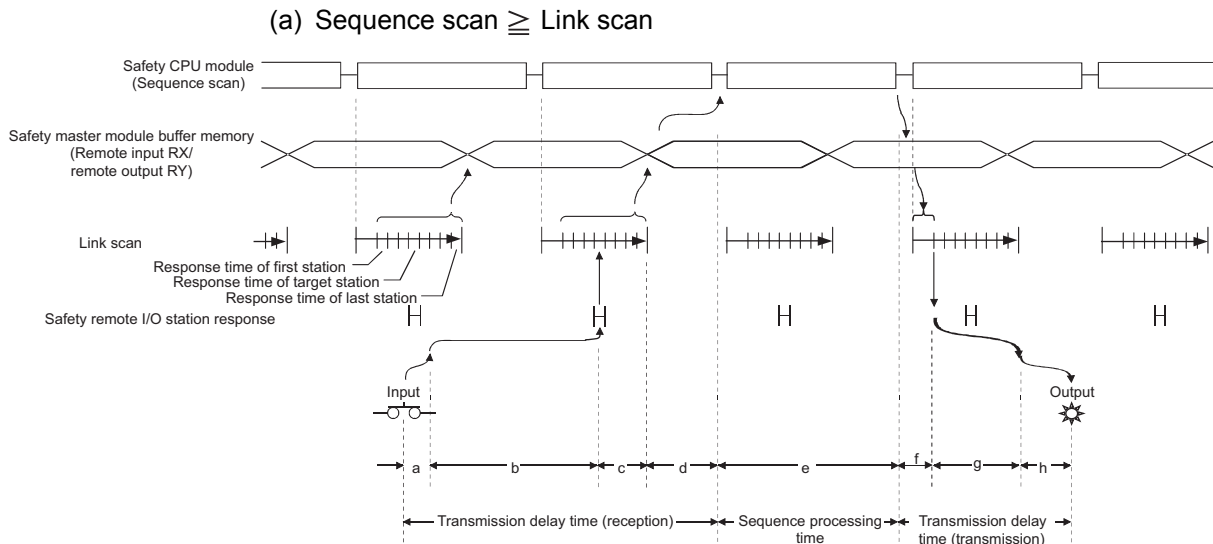

- a: Delay time due to a response delay of a safety remote I/O station
- b: Delay time due to data transmission from a safety remote I/O station to the safety master module
- c: Delay time elapsed from the time the safety master module receives the data until it stores them to the buffer memory
- d: Delay time elapsed until the data on the safety master module are refreshed to the safety CPU module
- e: Execution time of sequence processing

- f: Delay time due to data transmission from the safety master module to a safety remote I/O station
- g: Delay time due to internal processing of a safety remote I/O station
- h: Delay time due to a response delay of a safety remote I/O station

(b) Sequence scan < Link scan

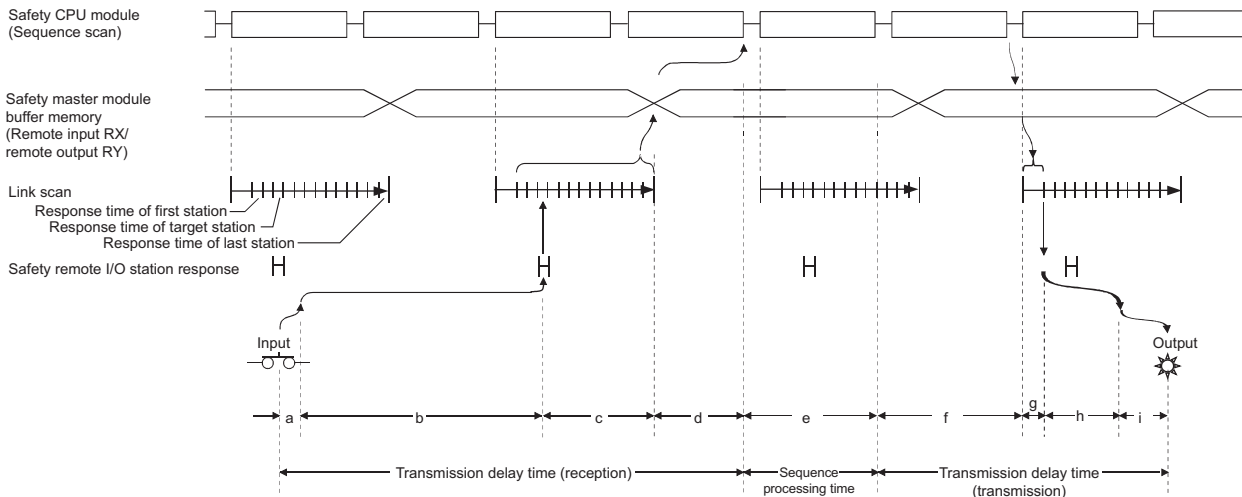

- a: Delay time due to a response delay of a safety remote I/O station
- b: Delay time due to data transmission from the safety remote I/O station to the safety master module
- c: Delay time elapsed from the time the safety master module receives the data until it stores them to the buffer memory
- d: Delay time elapsed until the data on the safety master module are refreshed to the safety CPU module
- e: Execution time of sequence processing
- f: Delay time due to data saving from the safety CPU module to the buffer memory
- g: Delay time due to data transmission from the safety master module to a safety remote I/O station
- h: Delay time due to internal processing of a safety remote I/O station
- i: Delay time due to a response delay of a safety remote I/O station

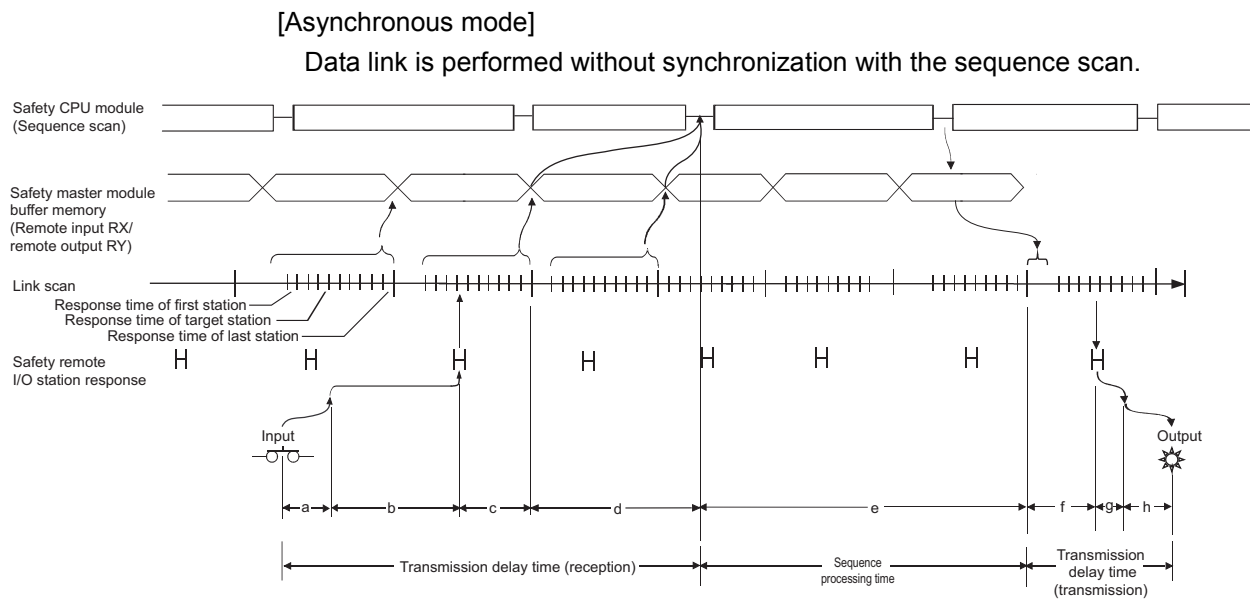

- a: Delay time due to a response delay of a safety remote I/O station
- b: Delay time due to data transmission from the safety remote I/O station to the safety master module
- c: Delay time elapsed from when the safety master module receives the data until it stores them to the buffer memory
- d: Delay time elapsed until the data on the safety master module are refreshed to the safety CPU module
- e: Execution time of sequence processing and delay time in storage from the safety CPU module to the buffer memory
- f: Delay time due to data transmission from the safety master module to the safety remote I/O station
- g: Delay time due to internal processing of the safety remote I/O station
- h: Delay time due to a response delay of the safety remote I/O station

[Setting method]

For the specification of the scan mode, refer to CHAPTER 6.

4.2.14 Safety remote station interlock function

When an error causing I/O stop occurs at a safety remote station, or when a communication error occurs between a safety master station and a safety remote station, this function prevents automatic restart of input/output to/from the relevant safety remote station(s).

If the safety master station detects an error in communication with a safety remote station, the corresponding station No. is identified as "Safety station interlock status".

[Safety monitoring timeout error]

A safety remote station monitors the time intervals between sending data to the safety master station and receiving next data from the safety master station using the safety refresh monitoring time and safety data monitoring time.

The safety remote station disconnects from the safety master station and waits for reconnection if not being able to receive data from the safety master station exceeding the safety refresh monitoring time or safety data monitoring time after sending data.

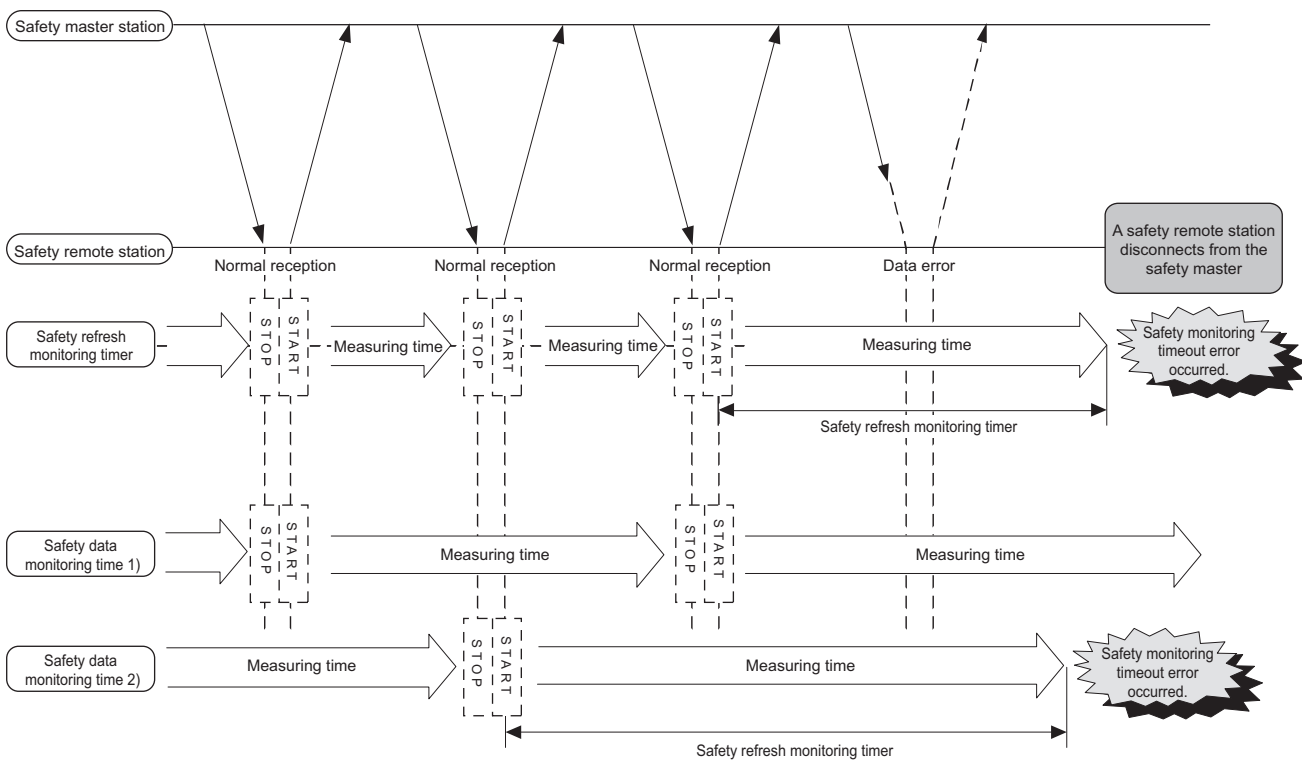

[How to confirm the interlock status]

The interlock status can be confirmed by the fact that the bit corresponding to the station number is ON in the special register SD1072 to SD1075 (Safety station interlock status).

If the safety remote station is connected to the second safety master module, check the special register SD1272 to SD1275.

(If the bit corresponding to the station No. is OFF, it does not indicate the interlock status.)

[How to clear the interlock]

In special register SD1076 to SD1079 (Safety station interlock clear request), turn the bit corresponding to the station No. from OFF to ON.

If the safety remote station is connected to the second safety master module, make a clear request at the special register SD1276 to SD1279.

POINT

For the special registers (SD), refer to the QSCPU User's Manual (Function Explanation, Program Fundamentals).

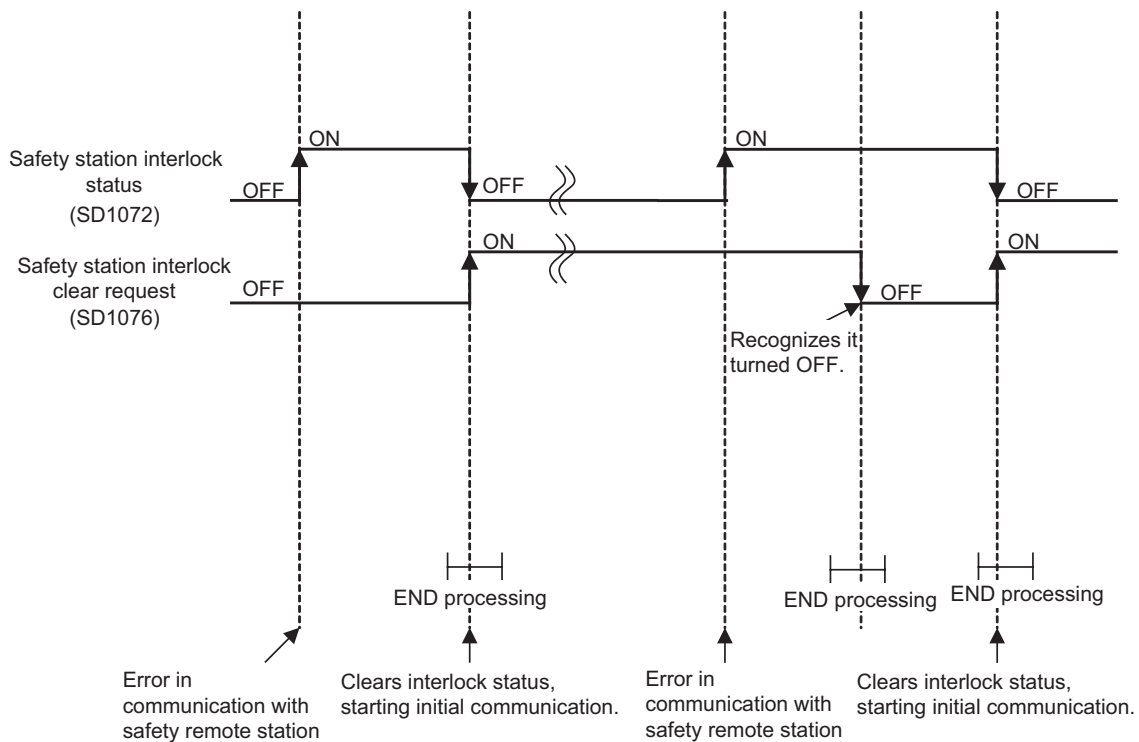

CHAPTER5 DATA LINK PROCESSING TIME AND STATION STATUS AT ERROR OCCURRENCE

This chapter explains the data link processing time including the link scan time and transmission delay time, and status of each station at error occurrence.

5.1 Link Scan Time

The following shows how to calculate the link scan time for the CC-Link Safety systems.

[Link scan time (LS)]

$$LS = BT \times \{27 + (NI \times 4.8) + (NW \times 9.6) + (N \times 30) + (ni \times 4.8) + (nw \times 9.6) + TR\} + ST + RT + F$$

[μs]

BT: Constant

Transmission rate	156kbps	625kbps	2.5Mbps	5Mbps	10Mbps
BT	51.2	12.8	3.2	1.6	0.8

NI : The last station number in A and B

(Including occupied stations but excluding reserved stations. It must be a multiple of 8.)

NW The last station number in B

(Including occupied stations but excluding reserved stations. It must be a multiple of 8.)

A : The last station No. of standard remote I/O stations

B : The last station No. of safety remote I/O stations and remote device stations (including occupied stations)

Last station number	1 to 8	9 to 16	17 to 24	25 to 32	33 to 40	41 to 48	49 to 56	57 to 64
NI,NW	8	16	24	32	40	48	56	64

N : Number of connected stations (excluding reserved stations)

ni : a + b (excluding reserved stations)

a: The total number of occupied standard remote I/O stations

b: The total number of occupied safety remote I/O stations and remote device stations

nw : b (excluding reserved stations)

TR : Constant

Constant	Value
TR	38.4

5 DATA LINK PROCESSING TIME AND STATION STATUS AT ERROR OCCURRENCE

ST : Constant (For Asynchronous mode only. For Synchronous mode, ST = 0)
 (1) or 2), whichever is greater. Ignore 2) when B = 0.)

$$1) 800 + (A \times 15)$$

$$2) 900 + (B \times 50)$$

RT : Retry processing time (only when a faulty station is detected)

$$\alpha + \beta \times (\text{No. of detected faulty stations} - 1)$$

α : Retry-and-return processing time for 1st module

$$BT \times [(200+R) \times \text{Preset No. of retries} + 200]$$

$$R: 51.6 + (NI \times 4.8) + (NW \times 9.6)$$

β : Retry-and-return processing time for 2nd or subsequent module

$$BT \times [(200+P) \times \text{Preset No. of retries} + 200]$$

$$P: 10.8$$

F : Return processing time (only when a faulty station exists)

$$BT \times 218 \times \text{No. of auto-return modules}$$

(Example) When the transmission rate is 10Mbps and the scan mode is Synchronous mode in the following system configuration (assuming that there is no faulty station.)

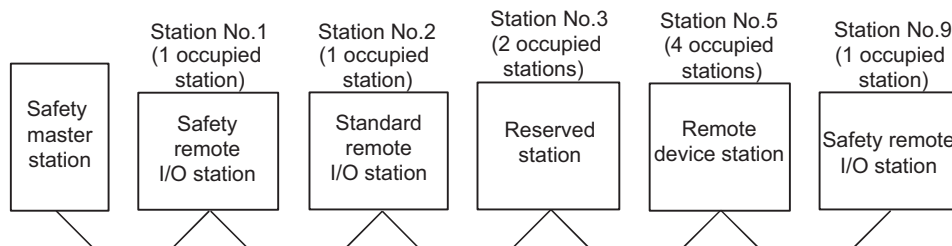

$$BT = 0.8$$

$$NI = 9 \rightarrow 16$$

$$a=1, b=6$$

$$NW = 9 \rightarrow 16$$

$$N = 4$$

$$ni = 7$$

$$nw = 6$$

$$TA = 38.4$$

$$LS = 0.8 \times \{27 + (16 \times 4.8) + (16 \times 9.6) + (4 \times 30) + (7 \times 4.8) + (6 \times 9.6) + 38.4\}$$

$$= 405.6 [\mu s]$$

$$= 0.41 [ms]$$

5.2 Transmission Delay Time

This section explains the transmission delay time (the length of time before data transmission is completed).

5.2.1 Safety master station ↔ Safety remote I/O station

(1) Safety refresh monitoring time

The safety refresh monitoring time is used to check that safety data link is normally performed between the safety master station and safety remote stations. If a response from a safety remote station is not received within the safety refresh monitoring time, a safety monitoring timeout occurs, and safety I/O data turn OFF. The safety refresh monitoring time is set as a network parameter.

The following shows how to calculate the safety refresh monitoring time. The time can be calculated in different formulas, depending on the combination of the versions of safety CPU module, safety master module, and safety remote I/O stations to be used. For the combination of the versions other than below, refer to Appendix 2.

Serial number (first five digits)			
Safety CPU module	Safety master module	Safety remote station	
		QS0J65BTS2-8D, QS0J65BTS2-4T	QS0J65BTB2-12DT
10032 or higher	10032 or higher	10031 or higher	10032 or higher

For the safety refresh monitoring time that is used for calculating the maximum value of safety response time, refer to the "Safety Application Guide".

[Calculation formula]

<Synchronous mode>

Safety refresh monitoring time $\geq (SM \times n) \times 3 + ((SM \times n) \times m) \times 2 + (SM \times \alpha)$
[ms]

- SM^{*1} : Sequence scan time of safety CPU module
- LS : Link scan time (Refer to Section 5.1.)
- n : (LS/SM) value that is rounded up to the nearest whole number
- m : {Safety refresh response processing time^{*2}/(SM × n)} value that is rounded up to the nearest whole number
- α : 0 when $LS \leq 1.5ms$, 1 when $LS > 1.5ms$.

☒ POINT

When the safety CPU module detects CC-LINK DATA RECEPTION TIMEOUT (error code: 8320 to 8322), increase the safety refresh monitoring time as needed.

(Example) In Synchronous mode, when the sequence scan time of the safety CPU module is 10ms, the link scan time is 1ms, the safety refresh response processing time is 9.6ms:

$$\begin{aligned} & (SM \times n) \times 3 + ((SM \times n) \times m) \times 2 + (SM \times \alpha) \text{ [ms]} \\ & = (10 \times 1) \times 3 + ((10 \times 1) \times 1) \times 2 + (10 + 0) \\ & = 50 \text{ [ms]} \end{aligned}$$

- * 1: For the calculation of SM, refer to the "QSCPU User's Manual (Function Explanation, Program Fundamentals)".
For precautions when specifying "Synchronous" mode in the Scan mode setting of Network parameter, refer to Section 4.2.13.
- * 2: For the safety refresh response processing time, refer to the manual of the relevant safety remote I/O station.

<Asynchronous mode>

$$\text{Safety refresh monitoring time} \geq (SM \times n) \times 3 + LS + ((SM \times n) \times m) \times 2 + (SM \times \alpha) \text{ [ms]}$$

- SM^{*1}: Sequence scan time of safety CPU module
- LS : Link scan time (Refer to Section 5.1.)
- n : (LS/SM) value that is rounded up to the nearest whole number
- m : {Safety refresh response processing time^{*2}/(SM × n)} value that is rounded up to the nearest whole number
-

(Example) In Asynchronous mode, when the sequence scan time of the safety CPU module is 10ms, the link scan time is 1ms, and the safety refresh response processing time is 9.6ms:

$$\begin{aligned} & (SM \times n) \times 3 + LS + ((SM \times n) \times m) \times 2 + (SM \times \alpha) \text{ [ms]} \\ & = (10 \times 1) \times 3 + 1 + ((10 \times 1) \times 1) \times 2 + (10 + 0) \\ & = 51 \text{ [ms]} \end{aligned}$$

- * 1: For the calculation of SM, refer to the "QSCPU User's Manual (Function Explanation, Program Fundamentals)".
- * 2: For the safety refresh response processing time, refer to the manual of the relevant safety remote I/O station.

(2) Safety data monitoring time

The safety data monitoring time is a monitoring time in a safety remote station, which is used to check that an operation, from reading a safety input from an external device to receiving a safety output from a safety master module, is performed normally.

If the operation does not complete within the specified safety data monitoring time, a safety data monitoring timeout occurs and the safety remote station turns safety input/output OFF.

The safety data monitoring time is set in Network parameter.

To enable the safety data monitoring time setting, use GX Developer and modules described below. The same calculation formula can be used for both Synchronous and Asynchronous modes.

GX Developer version	Serial number (first five digits)			
	Safety CPU module	Safety master module	Safety remote station	
			QS0J65BTS2-8D, QS0J65BTS2-4T	QS0J65BTB2-12DT
Ver.8.65T or later	10032 or higher	10032 or higher	10031 or higher	10032 or higher

[Calculation formula]

Safety data monitoring time \geq Safety refresh monitoring time $\times 2 - ((SM \times n) \times m) - 10$ [ms]

- SM^{*1}: Sequence scan time of safety CPU module
- LS : Link scan time (Refer to Section 5.1.)
- n : (LS/SM) value that is rounded up to the nearest whole number
- m : {Safety refresh response processing time^{*2}/(SM \times n)} value that is rounded up to the nearest whole number

(Example) When the sequence scan time of the safety CPU module is 10ms, and the safety refresh monitoring time is 50ms:

$$\begin{aligned} & \text{Safety refresh monitoring time} \times 2 - ((SM \times n) \times m) - 10 \text{ [ms]} \\ &= 50 \times 2 - ((10 \times 1) \times 1) - 10 \\ &= 80 \text{ [ms]} \end{aligned}$$

* 1: For the calculation of SM, refer to the "QSCPU User's Manual (Function Explanation, Program Fundamentals)".

* 2: For the safety refresh response processing time, refer to the manual of the relevant safety remote I/O station.

☒ POINT

When the safety CPU module detects CC-LINK DATA RECEPTION TIMEOUT (error code: 8320 to 8322), increase the safety refresh monitoring time and safety data monitoring time as needed.

(3) Safety master station (RX) ← Safety remote I/O station (input)

The following indicates the time from when a signal is input to a safety remote I/O station until when a device of the safety CPU module turns OFF (or ON).

The time can be calculated in different formulas, depending on the combination of the versions of safety CPU module, safety master module, and safety remote I/O stations to be used. The same calculation formula can be used for both Synchronous and Asynchronous modes. For the combination of the versions other than below, refer to Appendix 2.

Serial number (first five digits)			
Safety CPU module	Safety master module	Safety remote station	
		QS0J65BTS2-8D, QS0J65BTS2-4T	QS0J65BTB2-12DT
10032 or higher	10032 or higher	10031 or higher	10032 or higher

[Calculation formula]

[Normal value (CC-Link Safety line is stable.)]

$$(SM \times n) \times 3 + (SM \times n) \times m + \text{Safety remote station input response time}^{*2} \text{ [ms]}$$

- SM^{*1}: Sequence scan time of safety CPU module
- LS : Link scan time (Refer to Section 5.1.)
- n : (LS/SM) value that is rounded up to the nearest whole number
- m : {Safety refresh response processing time^{*2}/(SM × n)} value that is rounded up to the nearest whole number

(Example) When the sequence scan time of the safety CPU module is 10ms, the link scan time is 1ms, the safety refresh response processing time is 9.6ms, and the safety remote station input response time is 11.2ms:

$$\begin{aligned} & (SM \times n) \times 3 + (SM \times n) \times m + \text{Safety remote station input response time [ms]} \\ & = 10 + (10 \times 1) \times 3 + (10 \times 1) \times 1 + 11.2 \\ & = 51.2 \text{ [ms]} \end{aligned}$$

- * 1: For the calculation of SM, refer to the "QSCPU User's Manual (Function Explanation, Program Fundamentals)".
- * 2: For the safety refresh response processing time and the safety remote station input response time, refer to the manual of the relevant safety remote I/O station.

[Normal value (CC-Link Safety line is unstable.)]

(Safety refresh monitoring time × 2) + Safety remote station input response time^{*2} -
(((SM × n) × m) × 2 + (SM × n) + SM) [ms]

- SM^{*1}: Sequence scan time of safety CPU module
- LS : Link scan time (Refer to Section 5.1)
- n : (LS/SM) value that is rounded up to the nearest whole number
- m : {Safety refresh response processing time^{*2}/(SM × n)} value that is rounded up to the nearest whole number

(Example) When the sequence scan time of the safety CPU module is 10ms, the link scan time is 1ms, the safety refresh monitoring time is 50ms, and the safety remote station input response time is 11.2ms:

$$\begin{aligned} & (\text{Safety refresh monitoring time} \times 2) + \text{Safety remote station input} \\ & \text{response time} - (((\text{SM} \times \text{n}) \times \text{m}) \times 2 + (\text{SM} \times \text{n}) + \text{SM}) \text{ [ms]} \\ & = (50 \times 2) + 11.2 - (((10 \times 1) \times 1) \times 2 + (10 \times 1) + 10) \\ & = 71.2 \text{ [ms]} \end{aligned}$$

* 1: For the calculation of SM, refer to the "QSCPU User's Manual (Function Explanation, Program Fundamentals)".

* 2 For the safety refresh response processing time and the safety remote station input response time, refer to the manual of the relevant safety remote I/O station.

(4) Safety master station (RY) → Safety remote I/O station (output)

The following indicates the time from when a device of the safety CPU module turns OFF (or ON) until when a safety remote I/O station outputs OFF (or ON).

The time can be calculated in different formulas, depending on the combination of the versions of safety CPU module, safety master module, and safety remote I/O stations to be used. The same calculation formula can be used for both Synchronous and Asynchronous modes. For the combination of the versions other than below, refer to Appendix 2.

Serial number (first five digits)			
Safety CPU module	Safety master module	Safety remote station	
		QS0J65BTS2-8D, QS0J65BTS2-4T	QS0J65BTB2-12DT
10032 or higher	10032 or higher	10031 or higher	10032 or higher

[Calculation formula]

[Normal value (CC-Link Safety line is stable.)]

$$(SM \times n) + LS + (SM \times n) \times m + \text{Safety remote station output response time}^2 \text{ [ms]}$$

- SM^{*1}: Sequence scan time of safety CPU module
- LS : Link scan time (Refer to Section 5.1.)
- n : (LS/SM) value that is rounded up to the nearest whole number
- m : Safety refresh response processing time^{*2} / (SM × n) value that is rounded up to the nearest whole number

(Example) When the sequence scan time of the safety CPU module is 10ms, the link scan time is 1ms, the safety refresh monitoring time is 9.6ms, and the safety remote station output response time is 10.4ms:

$$\begin{aligned} & (SM \times n) + LS + (SM \times n) \times m + \text{Safety remote station output response time [ms]} \\ &= (10 \times 1) + 1 + (10 \times 1) \times 1 + 10.4 \\ &= 31.4 \text{ [ms]} \end{aligned}$$

* 1: For the calculation of SM, refer to the "QSCPU User's Manual (Function Explanation, Program Fundamentals)".
 * 2: For the safety refresh response processing time and the safety remote station output response time, refer to the manual of the relevant safety remote I/O station.

[Normal value (CC-Link Safety line is unstable.)]

(Safety refresh monitoring time × 2) + Safety remote station output response time^{*2} -
(((SM × n) × m) × 2 + (SM × n) + SM) [ms]

- SM^{*1}: Sequence scan time of safety CPU module
- LS : Link scan time (Refer to Section 5.1.)
- n : (LS/SM) value that is rounded up to the nearest whole number
- m : {Safety refresh response processing time^{*2}/(SM × n)} value that is rounded up to the nearest whole number

(Example) When the sequence scan time of the safety CPU module is 10ms, the link scan time is 1ms, the safety refresh monitoring time is 50ms, and the safety remote station output response time is 10.4ms:

$$\begin{aligned} & (\text{Safety refresh monitoring time} \times 2) + \text{Safety remote station} \\ & \text{output response time} - (((\text{SM} \times \text{n}) \times \text{m}) \times 2 + (\text{SM} \times \text{n}) + \text{SM}) \\ & \text{[ms]} \\ & = (50 \times 2) + 10.4 - (((10 \times 1) \times 1) \times 2 + (10 \times 1) + 10) \\ & = 70.4 \text{ [ms]} \end{aligned}$$

* 1: For the calculation of SM, refer to the "QSCPU User's Manual (Function Explanation, Program Fundamentals)".

* 2 For the safety refresh response processing time and the safety remote station output response time, refer to the manual of the relevant safety remote I/O station.

5 DATA LINK PROCESSING TIME AND STATION STATUS AT ERROR OCCURRENCE

(5) Response performance

The response performance is the time from when a signal is input to a remote station and then sequence processing is performed in the safety CPU module until when a signal is output from a remote station.

When a safety remote I/O station receiving input signals and another safety remote I/O station sending output signals are connected to the same safety master module, the following formulas can be used for calculating the response performance. The time can be calculated in different formulas, depending on the combination of the versions of safety CPU module, safety master module, and safety remote I/O stations to be used. For the combination of the versions other than below, refer to Appendix 2.

Serial number (first five digits)			
Safety CPU module	Safety master module	Safety remote station	
		QS0J65BTS2-8D, QS0J65BTS2-4T	QS0J65BTB2-12DT
10032 or higher	10032 or higher	10031 or higher	10032 or higher

[Calculation formula]

Safety remote station input response time + Safety data monitoring time + Safety remote station output response time [ms]

(Example)

- No. of connected stations : 2 safety remote stations (each of them occupies one station) (Scan mode: Synchronous mode)
- Transmission speed : 10Mbps (LS = 0.22ms)
- α : 0 due to $LS \leq 1.5ms$
- SM : 10ms
- Safety remote station : Input response time = 11.2ms, Output response time = 10.4ms³
- Safety data monitoring time = Safety refresh monitoring time $\times 2 - ((SM \times n) \times m) - 10$
 $= ((SM \times n) \times 3 + ((SM \times n) \times m) \times 2) + (SM \times \alpha) \times 2 - ((SM \times n) \times m) - 10$
 $= ((10 \times 1) \times 3 + ((10 \times 1) \times 1) \times 2 + 0) \times 2 - ((10 \times 1) \times 1) - 10$
 $= 80 [ms]$
- Response performance = 11.2 + 80 + 10.4
 $= 101.6 [ms]$

5.2.2 Safety master station ↔ Standard remote I/O station

(1) Safety master station (RX) ← Standard remote I/O station (input)

The following indicates the time from the moment a signal is input to a standard remote I/O station until a device of the safety CPU module turns ON (or OFF).

[Calculation formula]

[Normal value]

(a) Synchronous mode

$$(SM \times n) \times 1 + \text{Remote I/O station input response time}^{*1} \text{ [ms]}$$

- SM: Sequence scan time of safety CPU module
- LS : Link scan time (Refer to Section 5.1.)
- n : (LS/SM) value that is rounded up to the nearest whole number

(Example) When the sequence scan time of the safety CPU module is 20ms, the link scan time is 3ms, and the remote I/O station response time is 20ms:

$$\begin{aligned} & (SM \times n) \times 1 + \text{Remote I/O station response time [ms]} \\ & = (20 \times 1) \times 1 + 20 \\ & = 40 \text{ [ms]} \end{aligned}$$

(b) Asynchronous mode

$$SM + LS \times 1 + \text{Remote I/O station input response time}^{*1} \text{ [ms]}$$

- SM: Sequence scan time of safety CPU module
- LS : Link scan time (Refer to Section 5.1.)

(Example) When the sequence scan time of the safety CPU module is 10ms, the link scan time is 3ms, the safety refresh response processing time is 9.6ms, and the safety remote I/O station input response time is 12ms:

$$\begin{aligned} & SM + LS \times 1 + \text{Remote I/O station response time [ms]} \\ & = 10 + 3 \times 1 + 20 \\ & = 33 \text{ [ms]} \end{aligned}$$

5 DATA LINK PROCESSING TIME AND STATION STATUS AT ERROR OCCURRENCE

[Maximum value]

(a) Synchronous mode

$$(SM \times n) \times 2 + \text{Remote I/O station input response time}^{*1} \text{ [ms]}$$

- SM: Sequence scan time of safety CPU module
- LS : Link scan time (Refer to Section 5.1.)
- n : (LS/SM) value that is rounded up to the nearest whole number

(Example) When the sequence scan time of the safety CPU module is 20ms, the link scan time is 3ms, and the remote I/O station response time is 20ms:

$$\begin{aligned} & (SM \times n) \times 2 + \text{Remote I/O station response time [ms]} \\ &= (20 \times 1) \times 2 + 20 \\ &= 60 \text{ [ms]} \end{aligned}$$

(b) Asynchronous mode

$$SM + LS \times 2 + \text{Remote I/O station input response time}^{*1} \text{ [ms]}$$

- SM: Sequence scan time of safety CPU module
- LS : Link scan time (Refer to Section 5.1.)

(Example) When the sequence scan time of the safety CPU module is 20ms, the link scan time is 3ms, and the remote I/O station response time is 20ms:

$$\begin{aligned} & SM + LS \times 2 + \text{Remote I/O station response time [ms]} \\ &= 20 + 3 \times 2 + 20 \\ &= 46 \text{ [ms]} \end{aligned}$$

* 1 For the remote I/O station input response time, refer to the manual of the relevant standard remote I/O station.

(2) Safety master station (RY) → Standard remote I/O station (output)

The following indicates the time from the moment a device of the safety CPU module turns ON (or OFF) until a standard remote I/O station outputs ON (or OFF).

[Calculation formula]

[Normal value]

(a) Synchronous mode

$SM \times n + LS + \text{Remote I/O station output response time}^{*1}$ [ms]

- SM: Sequence scan time of safety CPU module
- LS : Link scan time (Refer to Section 5.1.)
- n : (LS/SM) value that is rounded up to the nearest whole number

(Example) When the sequence scan time of the safety CPU module is 20ms, the link scan time is 3ms, and the remote I/O station response time is 20ms:

$$\begin{aligned} & SM \times n + LS + \text{Remote I/O station response time [ms]} \\ &= 20 \times 1 + 3 + 20 \\ &= 43 \text{ [ms]} \end{aligned}$$

(b) Asynchronous mode

$SM + LS + \text{Remote I/O station output response time}^{*1}$ [ms]

- SM: Sequence scan time of safety CPU module
- LS : Link scan time (Refer to Section 5.1.)

(Example) When the sequence scan time of the safety CPU module is 20ms, the link scan time is 3ms, and the remote I/O station response time is 20ms:

$$\begin{aligned} & SM + LS + \text{Remote I/O station response time [ms]} \\ &= 20 + 3 + 20 \\ &= 43 \text{ [ms]} \end{aligned}$$

5 DATA LINK PROCESSING TIME AND STATION STATUS AT ERROR OCCURRENCE

[Maximum value]

(a) Synchronous mode

$$SM \times n + LS \times 2 + \text{Remote I/O station output response time}^{*1} \text{ [ms]}$$

- SM: Sequence scan time of safety CPU module
- LS : Link scan time (Refer to Section 5.1.)
- n : (LS/SM) value that is rounded up to the nearest whole number

(Example) When the sequence scan time of the safety CPU module is 20ms, link scan time is 3ms, and the remote I/O station response time is 20ms:

$$\begin{aligned} & SM \times n + LS \times 2 + \text{Remote I/O station response time [ms]} \\ &= 20 \times 1 + 3 \times 2 + 20 \\ &= 46 \text{ [ms]} \end{aligned}$$

(b) Asynchronous mode

$$SM + LS \times 2 + \text{Remote I/O station output response time}^{*1} \text{ [ms]}$$

- SM: Sequence scan time of safety CPU module
- LS : Link scan time (Refer to Section 5.1.)

(Example) When the sequence scan time of the safety CPU module is 20ms, the link scan time is 3ms, and the remote I/O station response time is 20ms:

$$\begin{aligned} & SM + LS \times 2 + \text{Remote I/O station response time [ms]} \\ &= 20 + 3 \times 2 + 20 \\ &= 46 \text{ [ms]} \end{aligned}$$

* 1 For the remote I/O station output response time, refer to the manual of the relevant standard remote I/O station.

5.2.3 Safety master station ↔ Remote device station

(1) Safety master station (RX) ← Remote device station (input/RWr)

The following indicates the time from the moment a signal is input to a remote device station until a device of the safety CPU module turns ON (or OFF).

[Calculation formula]

[Normal value]

(a) Synchronous mode

$(SM \times n) \times 1 + \text{Remote device station processing time}^{*1}$ [ms]

- SM: Sequence scan time of safety CPU module
- LS : Link scan time (Refer to Section 5.1.)
- n : (LS/SM) value that is rounded up to the nearest whole number

(Example) When the sequence scan time of the safety CPU module is 20ms, the link scan time is 3ms, and the remote device station processing time is 20ms:

$$\begin{aligned} & (SM \times n) \times 1 + \text{Remote device station processing time [ms]} \\ & = (20 \times 1) \times 1 + 20 \\ & = 40 \text{ [ms]} \end{aligned}$$

(b) Asynchronous mode

$SM + LS \times 1 + \text{Remote device station processing time}^{*1}$ [ms]

- SM: Sequence scan time of safety CPU module
- LS : Link scan time (Refer to Section 5.1.)

(Example) When the sequence scan time of the safety CPU module is 20ms, the link scan time is 3ms, and the remote device station processing time is 20ms:

$$\begin{aligned} & SM + LS \times 1 + \text{Remote device station processing time [ms]} \\ & = 20 + 3 \times 1 + 20 \\ & = 43 \text{ [ms]} \end{aligned}$$

5 DATA LINK PROCESSING TIME AND STATION STATUS AT ERROR OCCURRENCE

[Maximum value]

(a) Synchronous mode

$$(SM \times n) \times 2 + \text{Remote device station processing time}^{*1} \text{ [ms]}$$

- SM: Sequence scan time of safety CPU module
- LS : Link scan time (Refer to Section 5.1.)
- n : (LS/SM) value that is rounded up to the nearest whole number

(Example) When the sequence scan time of the safety CPU module is 20ms, the link scan time is 3ms, and the remote device station processing time is 20ms:

$$\begin{aligned} & (SM \times n) \times 2 + \text{Remote device station processing time [ms]} \\ &= (20 \times 1) \times 2 + 20 \\ &= 60 \text{ [ms]} \end{aligned}$$

(b) Asynchronous mode

$$SM + LS \times 2 + \text{Remote device station processing time}^{*1} \text{ [ms]}$$

- SM: Sequence scan time of safety CPU module
- LS : Link scan time (Refer to Section 5.1.)

(Example) When the sequence scan time of the safety CPU module is 20ms, the link scan time is 3ms, and the remote device station processing time is 20ms:

$$\begin{aligned} & SM + LS \times 2 + \text{Remote device station processing time [ms]} \\ &= 20 + 3 \times 2 + 20 \\ &= 46 \text{ [ms]} \end{aligned}$$

* 1 For the remote device station processing time, refer to the manual of the relevant remote device station.

(2) Safety master station (RY) → Remote device station (output/RWw)

The following indicates the time from the moment a device of the safety CPU module turns ON (or OFF) until the remote device station outputs ON (or OFF).

[Calculation formula]

[Normal value]

(a) Synchronous mode

$$SM \times n + LS + \text{Remote device station processing time}^{*1} \text{ [ms]}$$

- SM: Sequence scan time of safety CPU module
- LS : Link scan time (Refer to Section 5.1.)
- n : (LS/SM) value that is rounded up to the nearest whole number

(Example) When the sequence scan time of the safety CPU module is 20ms, the link scan time is 3ms, and the remote device station processing time is 20ms:

$$\begin{aligned} & SM \times n + LS + \text{Remote device station processing time [ms]} \\ &= 20 \times 1 + 3 + 20 \\ &= 43 \text{ [ms]} \end{aligned}$$

(b) Asynchronous mode

$$SM + LS + \text{Remote device station processing time}^{*1} \text{ [ms]}$$

- SM: Sequence scan time of safety CPU module
- LS : Link scan time (Refer to Section 5.1.)

(Example) When the sequence scan time of the safety CPU module is 20ms, the link scan time is 3ms, and the remote device station processing time is 20ms:

$$\begin{aligned} & SM + LS + \text{Remote device station processing time [ms]} \\ &= 20 + 3 + 20 \\ &= 43 \text{ [ms]} \end{aligned}$$

5 DATA LINK PROCESSING TIME AND STATION STATUS AT ERROR OCCURRENCE

[Maximum value]

(a) Synchronous mode

$$SM \times n + LS \times 2 + \text{Remote device station processing time}^{*1} \text{ [ms]}$$

- SM: Sequence scan time of safety CPU module
- LS : Link scan time (Refer to Section 5.1.)
- n : (LS/SM) value that is rounded up to the nearest whole number

(Example) When the sequence scan time of the safety CPU module is 20ms, the link scan time is 3ms, and the remote device station processing time is 20ms:

$$\begin{aligned} & SM \times n + LS \times 2 + \text{Remote device station processing time [ms]} \\ &= 20 \times 1 + 3 \times 2 + 20 \\ &= 46 \text{ [ms]} \end{aligned}$$

(b) Asynchronous mode

$$SM + LS \times 2 + \text{Remote device station processing time}^{*1} \text{ [ms]}$$

- SM: Sequence scan time of safety CPU module
- LS : Link scan time (Refer to Section 5.1.)

(Example) When the sequence scan time of the safety CPU module is 20ms, the link scan time is 3ms, and the remote device station processing time is 20ms:

$$\begin{aligned} & SM + LS \times 2 + \text{Remote device station processing time [ms]} \\ &= 20 + 3 \times 2 + 20 \\ &= 46 \text{ [ms]} \end{aligned}$$

* 1 For the remote device station processing time, refer to the manual of the relevant remote device station.

5.3 Auto Refresh Time

This section explains the auto refresh time (the extended time in the END processing time, which is spent for automatic refresh processing of the safety CPU module).

[Calculation formula]

$$KM1 + KM2 \times [(RX + RY) / 16 + RWw + RWr] + [KM3 \times (\text{Total number of connected stations})] + KM4 \times [(SB / 16) + SW] \text{ [ms]}$$

- RX : Remote input (RX) points refreshed by the safety master station
- RY : Remote output (RY) points refreshed by the safety master station
- RWw: Remote register (RWw) points refreshed by the safety master station
- RWr : Remote register (RWr) points refreshed by the safety master station
- SB : Link special relay (SB) points refreshed by the safety master station
- SW : Link special register (SW) points refreshed by the safety master station
- Total number of connected stations: Total number of connected remote stations (Including reserved stations)

•KM1 : Constant *1

Number of modules mounted	KM1	
	1)	2)
One safety master module is mounted	2.6	5.3
Two safety master modules are mounted	3.9	10.6

•KM2 : Constant *1

KM2	
1)	2)
0.0034	0.0043

•KM3 : Constant *1

KM3	
1)	2)
0.053	0.066

•KM4 : Constant *1

KM4	
1)	2)
0.003	0.00375

* 1: 1) and 2) in the table indicate the combination of the versions of modules.

- 1) Combination of the safety CPU module, safety master module, and safety remote I/O station (QS0J65BTB2-12DT) whose serial number (first five digits) is '10032' or higher. (For the safety remote I/O station (QS0J65BTS2-8D and QS0J65BTS2-4T), the serial number (first five digits) '10031' or higher is targeted.)
- 2) Combination other than 1).

5 DATA LINK PROCESSING TIME AND STATION STATUS AT ERROR OCCURRENCE

(Example) When RX 1344 points, RY 1344 points, RWw 168 points, RWr 168 points, SB 512 points, and SW 512 points are refreshed in a system including a single safety master module (The number of connected safety remote I/O stations is 42):

$$\begin{aligned} \text{Auto refresh time} &= \text{KM1} + \text{KM2} \times [(\text{RX} + \text{RY}) / 16 + \text{RWw} + \text{RWr}] + \\ &\quad [\text{KM3} \times (\text{Total number of connected stations})] + \text{KM4} \times \\ &\quad [(\text{SB} / 16) + \text{SW}] \\ &= 2.6 + 0.0034 \times [(1344 + 1344) / 16 + 168 + 168] + \\ &\quad (0.053 \times 42) + 0.003 \times [(512 / 16) + 512] \\ &= 8.17 \text{ [ms]} \end{aligned}$$

1
OVERVIEW

2
SYSTEM CONFIGURATION

3
SPECIFICATIONS

4
FUNCTIONS

5
DATA LINK PROCESSING TIME AND STATION STATUS AT ERROR OCCURRENCE

6
PARAMETER SETTINGS

7
PROCEDURE BEFORE STARTING THE DATA LINK

8
PROGRAMMING SPECIFICATIONS

5.4 Station Status at Error Occurrence

Table5.1 lists station status at error occurrence in classification by station type. In Table5.1, the data in the "Safety master station" column represent the following:

Remote input (RX)	Remote register (RWr)	Remote output (RY)	Remote register (RWw)
Automatic refresh operation of safety CPU module		Automatic refresh operation of safety CPU module	
Status of refresh target CPU device		Status of refresh target buffer memory	

Table5.1 Station status at error occurrence (1/3)

Data link status	Safety master station				Remote I/O station		Remote device station,				
	Remote input (RX)	Remote register (RWr)	Remote output (RY)	Remote register (RWw)	Input	Output	Remote input (RX)	Remote register (RWr)	Remote output (RY)	Remote register (RWw)	
When the safety CPU module on the safety master station is stopped due to an error (Data link stop)	The send/receive area of a safety remote I/O station				Safety remote I/O station		Depends on the spec. of the remote station	Depends on the spec. of the remote station	Depends on the spec. of the remote station	Depends on the spec. of the remote station	
	Stop	-	Stop	-							
	Hold	-	Hold ^{*2}	-							
	The send/receive area of a standard remote I/O station				Depends on external signals	All points OFF					
	Stop	-	Stop	-							
	Hold	-	Hold	-	Standard remote I/O station						
	The send/receive area of a remote device station				Depends on external signals	All points OFF ^{*1}					
	Stop	Stop	Stop	Stop							
Hold	Hold	Hold	Hold								
When data link for the entire system is stopped (Clears inputs from data link faulty stations)	The send/receive area of a safety remote I/O station				Safety remote I/O station		Depends on the spec. of the remote station	Depends on the spec. of the remote station	Depends on the spec. of the remote station	Depends on the spec. of the remote station	
	Auto-refreshes the clear data	-	Stop	-	Depends on external signals	All points OFF					
	All points OFF	-	Hold	-							
	The send/receive area of a standard remote I/O station										
	Auto-refreshes the clear data	-	Continue	-	Standard remote I/O station						
	All points OFF	-	Update	-							
	The send/receive area of a remote device station										
	Auto-refreshes the clear data	Stop	Continue	Continue	Depends on external signals	All points OFF ^{*1}					
All points OFF	Hold	Update	Update								

* 1: Some types of remote I/O stations allow the selection of the output mode (hold/clear) for the case of a communication error. Their operation differs depending on the setting.

* 2: When the safety CPU module stops due to error detection, the automatic refresh processing is stopped. Because of this, the remote output (RY) in the buffer memory is held regardless of whether the slave station forced clear function at safety CPU STOP is enabled or not.

5 DATA LINK PROCESSING TIME AND STATION STATUS AT ERROR OCCURRENCE

Table5.1 Station status at error occurrence (2/3)

Data link status	Safety master station				Remote I/O station		Remote device station,			
	Remote input (RX)	Remote register (RW _r)	Remote output (RY)	Remote register (RW _w)	Input	Output	Remote input (RX)	Remote register (RW _r)	Remote output (RY)	Remote register (RW _w)
When a communication error occurs in a safety remote I/O station (Clears inputs from data link faulty stations)	The send/receive area of the safety remote I/O station with the communication error				Station with the communication error (safety station)		Continue	Continue	Continue	Continue
	Auto-refreshes the clear data	-	Stop	-	Depends on external signals	All points OFF				
	All points OFF	-	Hold	-						
	The send/receive area of a normal safety or standard remote I/O station				Normal station					
	Continue	-	Continue	-	Continue	Continue				
	Depends on the input	-	Update	-						
	The send/receive area of a normal remote device station									
	Continue	Continue	Continue	Continue						
Depends on the input	Depends on the input	Update	Update							
When a communication error occurs in a standard remote I/O station (Clears inputs from data link faulty stations)	The send/receive area of the standard remote I/O station with the communication error				Station with the communication error (standard station)		Continue	Continue	Continue	Continue
	Auto-refreshes the clear data	-	Continue	-	Depends on external signals	All points OFF *1				
	All points OFF	-	Update	-						
	The send/receive area of a normal safety or standard remote I/O station				Normal station					
	Continue	-	Continue	-	Continue	Continue				
	Depends on the input	-	Update	-						
	The send/receive area of a normal remote device station									
	Continue	Continue	Continue	Continue						
Depends on the input	Depends on the input	Update	Update							

* 1: Some types of remote I/O stations allow the selection of the output mode (hold/clear) for the case of a communication error. Their operation differs depending on the setting.

1 OVERVIEW
2 SYSTEM CONFIGURATION
3 SPECIFICATIONS
4 FUNCTIONS
5 DATA LINK PROCESSING TIME AND STATION STATUS AT ERROR OCCURRENCE
6 PARAMETER SETTINGS
7 PROCEDURE BEFORE STARTING THE DATA LINK
8 PROGRAMMING SPECIFICATIONS

5 DATA LINK PROCESSING TIME AND STATION STATUS AT ERROR OCCURRENCE

Table5.1 Station status at error occurrence (3/3)

Data link status	Safety master station				Remote I/O station		Remote device station,					
	Remote input (RX)	Remote register (RWr)	Remote output (RY)	Remote register (RWw)	Input	Output	Remote input (RX)	Remote register (RWr)	Remote output (RY)	Remote register (RWw)		
When a communication error occurs in a remote device station (Clears inputs from data link faulty stations)	The send/receive area of the remote device station with the communication error				Continue	Continue	faulty station					
	Auto-refreshes the clear data	Stop	Continue	Continue			Depends on the spec. of the remote station	Depends on the spec. of the remote station	Depends on the spec. of the remote station	Depends on the spec. of the remote station		
	All points OFF	Hold	Update	Update			Normal station					
	The send/receive area of a normal safety or standard remote I/O station											
	Continue	Continue	Continue	Continue			Continue	Continue	Continue	Continue	Continue	Continue
	Depends on the input	Depends on the input	Update	Update								
	The send/receive area of a normal remote device station											
	Continue	Continue	Continue	Continue								
	Depends on the input	Depends on the input	Update	Update								

* 1: Some types of remote I/O stations allow the selection of the output mode (hold/clear) for the case of a communication error. Their operation differs depending on the setting.

CHAPTER6 PARAMETER SETTING

This chapter explains the parameter setting that is required to perform data link in the CC-Link Safety systems.

6.1 Procedure for Parameter Setting and Data Link Startup

The following explains the procedure for setting the parameters and starting the data link. For procedures for starting operations after the parameter setting, refer to Section 7.1.

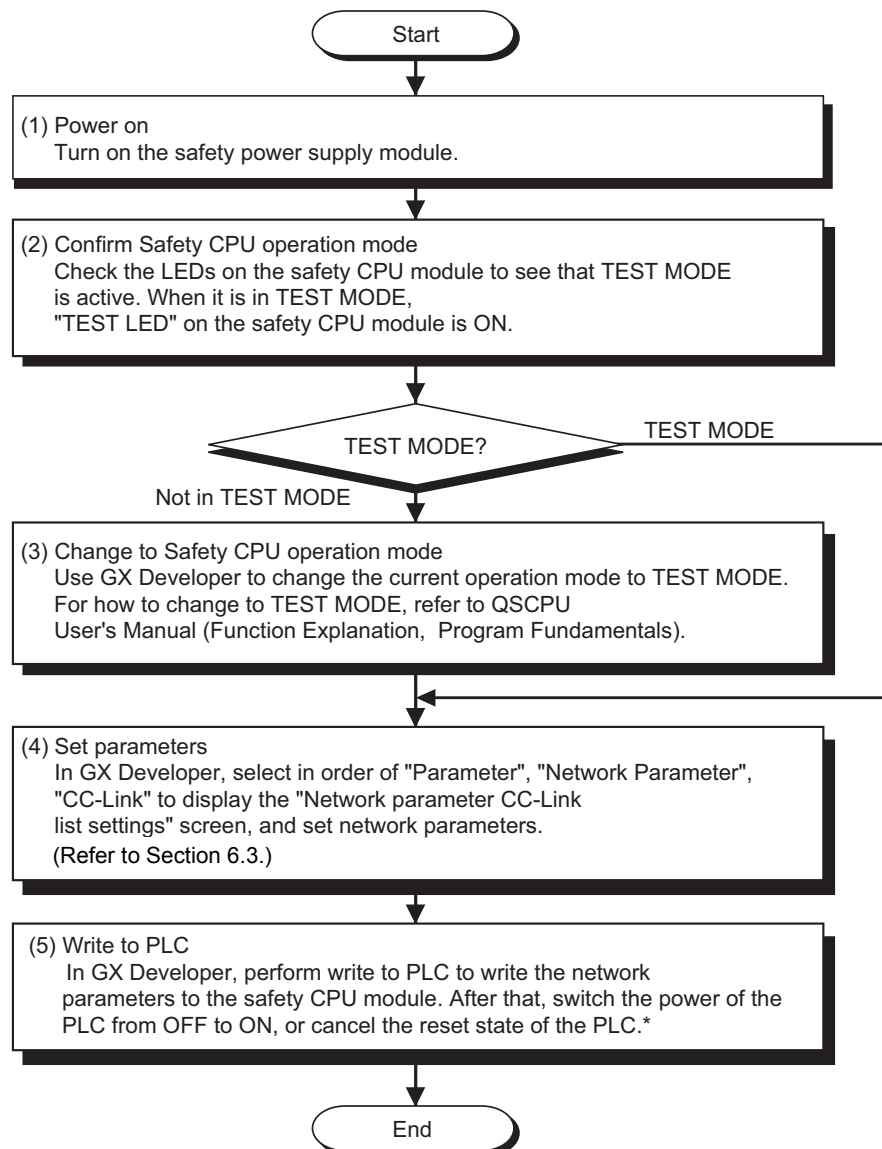

* "PARAMETER ERROR" (error code: 3008) occurs on the safety CPU module if a remote station is powered ON from OFF or is reset without switching the PLC power from OFF to ON or canceling the reset state of the safety CPU module after writing the network parameters.

6.2 Parameter Setting Items

Table6.1 lists the parameter setting items.

Table6.1 Parameter setting items (1/2)

Setting item	Description	Reference section
No. of boards in module	Set the number of modules installed with a single safety CPU module. Default value: No setting Setting range: 1 to 2	Section 6.3.1 (2)(a)
Start I/O No.	Enter the head I/O number. Default value: No setting Setting range: 0000 to 03E0	Section 6.3.1 (2)(b)
Case of safety CPU STOP setting	Set the output data status of the remote output (RY) for the case of the safety CPU module stop. Fixed to forced clear if the safety CPU module is in SAFETY MODE. Default value: Refresh Setting range: Refresh Clears compulsorily	Section 4.2.10, Section 6.3.1 (2)(d)
Station No.	Set the station number of a remote station for which the line test is performed. Setting is available only when the mode is set to "Line test". Default value: 0 (All stations) Setting range: 0 to 64	—
Mode	Set the operation mode.(*) For communication with slave stations, select "Safety remote net (Ver.1 mode)". For operation check, select "Hardware test" or "Line test". To disable communication, select "Off line". Default value: Safety remote net (Ver.1 mode) Setting range: Safety remote net (Ver.1 mode) Off line Hardware test Line test	Section 6.3.1 (2)(e)
Transmission speed	Set the transmission speed of the module. Default value: 156kbps Setting range: 156kbps 625kbps 2.5Mbps 5Mbps 10Mbps	Section 6.3.1 (2)(f)
Safety refresh monitoring time	Set the monitoring time used between the safety master station and safety remote stations. Default value: 200 (ms) Setting range: 1 to 65535 (ms)	Section 4.2.6, Section 5.2.1, Section 6.3.1 (2)(g)
Safety data monitoring time	Set the monitoring time used in a safety remote station. Default value: 400 (ms) Setting range: 1 to 65535 (ms)	Section 4.2.14, Section 5.2.1, Section 6.3.1 (2)(h)
Link ID	Set a link ID for each safety master module. Default value: 0 Setting range: 0 to 7	Section 6.3.1 (2)(i)
All connect count	Set the number of safety remote I/O stations, standard remote I/O stations and remote device stations that are connected to the safety master station. (including reserved stations) Default value: 64 Setting range: 1 to 64	Section 6.3.1 (2)(j)

* When "Offline" is set, it does not communicate with remote stations as a safety master station.

"CC-LINK PARAMETER ERROR" occurs if "Hardware test" or "Line test" is set when the safety CPU module is in any other than TEST MODE.

6 PARAMETER SETTING

Table 6.1 Parameter setting items (2/2)

Setting item	Description	Reference section
Remote input (RX)	Set a device to which remote input (RX) is refreshed by the automatic refresh function. Default value: No setting Setting range: X, M, B, D, W (The device number must be within the device range of the safety CPU module.)	Section 6.3.1 (2)(k)
Remote output (RY)	Set a device to which remote output (RY) is refreshed by the automatic refresh function. Default value: No setting Setting range: Y, M, B, D, W, T, ST, C (The device number must be within the device range of the safety CPU module.)	Section 6.3.1 (2)(l)
Remote register (RW _r)	Set a device to which remote register (RW _r) is refreshed by the automatic refresh function. Default value: No setting Setting range: W, D, B, M (The device number must be within the device range of the safety CPU module.)	Section 6.3.1 (2)(m)
Remote register (RW _w)	Set a device to which remote register (RW _w) is refreshed by the automatic refresh function. Default value: No setting Setting range: W, D, B, M, T, ST, C (The device number must be within the device range of the safety CPU module.)	Section 6.3.1 (2)(n)
Special relay (SB)	Set a device to which link special relay (SB) is refreshed by the automatic refresh function. Default value: No setting Setting range: SB, B, M, W, D (The device number must be within the device range of the safety CPU module.)	Section 6.3.1 (2)(o)
Special register (SW)	Set a device to which link special register (SW) is refreshed by the automatic refresh function. Default value: No setting Setting range: SW, W, D, B, M (The device number must be within the device range of the safety CPU module.)	Section 6.3.1 (2)(p)
Retry count	Set the number of retries for the case where a communication error occurs. Default value: 3 (times) Setting range: 1 to 7 (times)	Section 6.3.1 (2)(q)
Automatic reconnection station count	Set the number of safety remote I/O stations, standard remote I/O stations and remote device stations that can rejoin the network in one link scan. Default value: 1 Setting range: 1 to 10	Section 4.2.7, Section 6.3.1 (2)(r)
Scan mode setting	Specify whether to make the link scan synchronous or asynchronous with the sequence scan. Default value: Synchronous Setting range: Synchronous or Asynchronous	Section 4.2.1 to Section 4.2.2, Section 6.3.1 (2)(s)
Station information setting	Set the type of a connected safety remote I/O station, standard remote I/O station or remote device station. Default value: "Standard remote I/O station, 1 station occupied, station No. 1, no reserved station" to "Standard remote I/O station, 1 station occupied, station No. 64, no reserved station" Setting range Station type: Safety remote I/O station, standard remote I/O station, remote device station Number of occupied stations: 1 to 4 Station No.: 1 to 64 Reserved station setting: Not specified, Specified	Section 6.3.1 (2)(t)
Safety station information	Set a product model name, production information, etc. of a safety remote I/O station.	-
Safety remote station setting	Set parameters of safety remote stations. For setting details, refer to manual of the safety remote station to be used.	Section 6.3.1 (2)(u)

1 OVERVIEW
2 SYSTEM CONFIGURATION
3 SPECIFICATIONS
4 FUNCTIONS
5 DATA LINK PROCESSING TIME AND STATION STATUS AT ERROR OCCURRENCE
6 PARAMETER SETTINGS
7 PROCEDURE BEFORE STARTING THE DATA LINK
8 PROGRAMMING SPECIFICATIONS

6.3 Parameter Setting Example

This section explains the parameter setting on GX Developer. For details on the GX Developer operation, refer to the GX Developer Operating Manual. The explanations in this section are based on the following system configuration example.

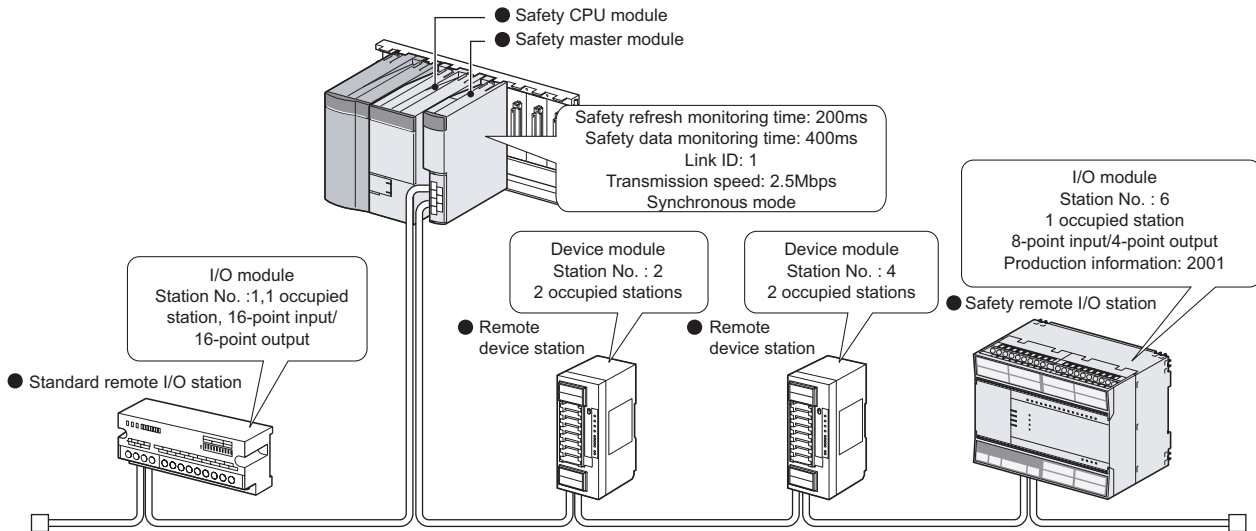

6.3.1 Safety master station network parameter setting

(1) The following is an example of the parameter settings. See (2) for actual settings.

Network parameters Setting the CC-Link list.

No. of boards in module: 1 Boards Blank: no setting.

	1	2	3	4
Start I/O No	0000			
Operational setting	Operational settings			
Type	Safety master station			
Station No	0			
Master station data link type	PLC parameter auto start			
Mode	Safety remote net(Ver. 1 mode)			
Transmission speed	156kbps			
Safety refresh monitoring time	200			
Safety data monitoring time	400			
Link ID	0			
All connect count	64			
Remote input[RX]	X400			
Remote output[R/Y]	Y400			
Remote register[R/W]	w0			
Remote register[R/Ww]	w100			
Special relay[SB]	S80			
Special register[SW]	SW0			
Retrv count	3			
Automatic reconnection station count	1			
PLC down select	Stop			
Scan mode setting	Synchronous			
Delay information setting	0			
Station information setting	Station information			
Remote device station initial setting				

Indispensable settings(No setting / Already set) Set if it is needed(No setting / Already set)

Setting item details:

Acknowledge XY assignment Clear Check End Cancel

(2) Set the network parameters in the following steps.

- (a) Set the "No. of boards in module " for which the network parameters are to be set.**

Default value : None
 Setting range: 1 to 2 (Boards) *

Example) Set 1 (Board).

- (b) Set the "Start I/O No." for the master station.**

Default value : None
 Setting range: 0000 to 03E0

Example) Enter "0000".

- (c) Set a parameter name for "Operational settings." (Setting no parameter name will not affect the operation of the CC-Link system).**

Default value : None
 Setting range: 8 characters or less

Example) Enter "SYSTEM1".

- (d) Set whether to refresh or forcibly clear data at PLC CPU STOP in "Operational settings".**

Default value : Refresh ("Clears compulsorily " not checked)
 Setting range: Refresh ("Clears compulsorily " not checked)
 Clears compulsorily ("Clears compulsorily" checked)

Example) Select "Clears compulsorily. ("Clears compulsorily" checked.)

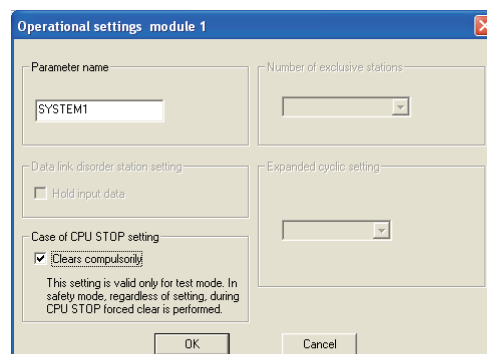

(e) Set a mode of the CC-Link Safety system in "Mode".

Default value: Safety remote net (Ver.1 mode)

Setting range: Safety remote net (Ver.1 mode)

Offline

Hardware test

Line test

Example) Select "Safety remote net (Ver.1 mode)".

(f) Set transmission speed of the CC-Link Safety system in "Transmission speed".

Default value: 156kbps

Setting range: 156kbps

625kbps

2.5Mbps

5Mbps

10Mbps

Example) Select "2.5Mbps".

(g) Set the monitoring time for a safety remote station in "Safety refresh monitoring time".

Default value: 200 (ms)

Setting range: 1 to 65535 (ms)

Example) Set to 200ms. (Enter "200".)

(h) Set the monitoring time for a safety remote station in "Safety data monitoring time".

Default value: 400 (ms)

Setting range: 1 to 65535 (ms)

Example) Set to 400ms. (Enter "200".)

(i) Set a link ID to be allotted for each safety master station in "Link ID".

Default value: 0

Setting range: 0 to 7

Example) Enter "1".

(j) Set the total number of connected stations in the CC-Link safety system including reserved stations in "All connect count".

Default value : 64

Setting range: 1 to 64

Example) Set to 4 (modules). (Enter "4".)

(k) Specify a refresh device for remote input (RX) in "Remote input (RX)".

Default value : None

Setting range: Device name - Select from X, M, B, D or W.

Device number - Within the range of the device points that the CPU has.

Example) Enter "X400".

(l) Specify a refresh device for remote output (RY) in "Remote output (RY)".

Default value : None

Setting range: Device name - Select from Y, M, B, D,W,T,ST or C.

Device number - Within the range of the device points that the CPU has.

Example) Set to Y400.

(m) Specify a refresh device for remote register (RW_r) in "Remote register (RW_r)".

Default value : None

Setting range: Device name - Select from W, D, B or M.

Device number - Within the range of the device points that the CPU has.

Example) Enter "W0".

(n) Specify a refresh device for remote register (RW_w) in "Remote register (RW_w)".

Default value : None

Setting range: Device name - Select from W, D, B, M, T, ST or C.

Device number - Within the range of the device points that the CPU has.

Example) Enter "W100".

(o) Specify a refresh device for link special relay (SB) in "Special relay (SB)".

Default value : None

Setting range: Device name - Select from SB, B, M, W or D.

Device number - Within the range of the device points that the CPU has.

Example) Enter "SB0".

(p) Specify a refresh device for link special register (SW) in "Special register (SW)".

Default value : None

Setting range: Device name - Select from SW, W, D, B or M.

Device number - Within the range of the device points that the CPU has.

Example) Enter "SW0".

POINT

When setting X, Y, B, W, SB and SW as refresh devices, make sure that the settings do not overlap with the device numbers used on other networks, etc.

(q) Set the number of retries to be performed when a communication error occurs in "Retry count".

Default value : 3 (times)

Setting range: 1 to 7 (times)

Example) Set to 3. (Enter "3".)

(r) Set the number of modules that can rejoin the system in a single link scan in "Automatic reconnection station count".

Default value : 1

Setting range: 1 to 10

Example) Set to 1. (Enter "1".)

(s) In the "Scan mode setting", set whether to synchronize the link scan with the sequence scan or not.

Default value: Synchronous

Setting range: Synchronous

Asynchronous

(t) Set the station data in "Station information setting".

Default value: Standard remote I/O station, 1 station occupied, No reserved station

Setting range: Station type -

No setting

Safety remote I/O station

Standard remote I/O station

Remote device station

Number of occupied stations -No setting

Occupies 1 station

Occupies 2 stations

Occupies 3 stations

Occupies 4 stations

Reserved station specification

No setting

Reserved station

Example) Select each of station data according to the system configuration specified in Section 6.3.

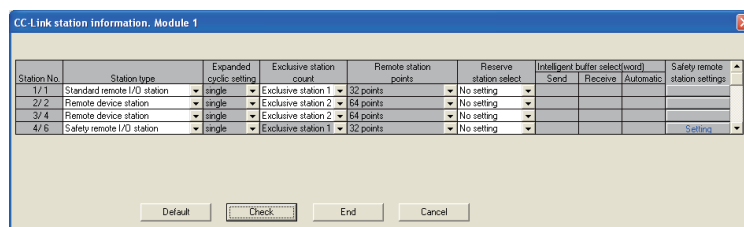

- (u) Click the "Set" button located under the Safety remote station setting on the "Station information" screen, and set the safety remote station parameters.

For the settings, refer to the manual of the safety remote module to be used. Example) The following is a setting example for the QS0J65BTB2-12DT.

Safety remote station settings

Station: 6
 Module: Safety remote I/O station
 Model name: QS0J65BTB2-12DT
 Module technical version: A

Specify production information to find module
 Production information:

	Parameter item	Setting value	Unit
1	Time of noise removal filter X0,1	1ms	
2	Time of noise removal filter X2,3	1ms	
3	Time of noise removal filter X4,5	1ms	
4	Time of noise removal filter X6,7	1ms	
5	Time of noise removal filter X8,9	1ms	
6	Time of noise removal filter XA,B	1ms	
7	Time of noise removal filter XC,D	1ms	
8	Time of noise removal filter XE,F	1ms	
9	Doubling input disagreement detection time X0,1	1	* 20ms
10	Doubling input disagreement detection time X2,3	1	* 20ms

Detail:

Default Check End Cancel

CHAPTER7 PROCEDURE BEFORE STARTING DATA LINK

This chapter explains the procedure from the module installation to the data link startup.

7.1 Procedures before System Operation

The following describes the procedure from the module installation to system startup.

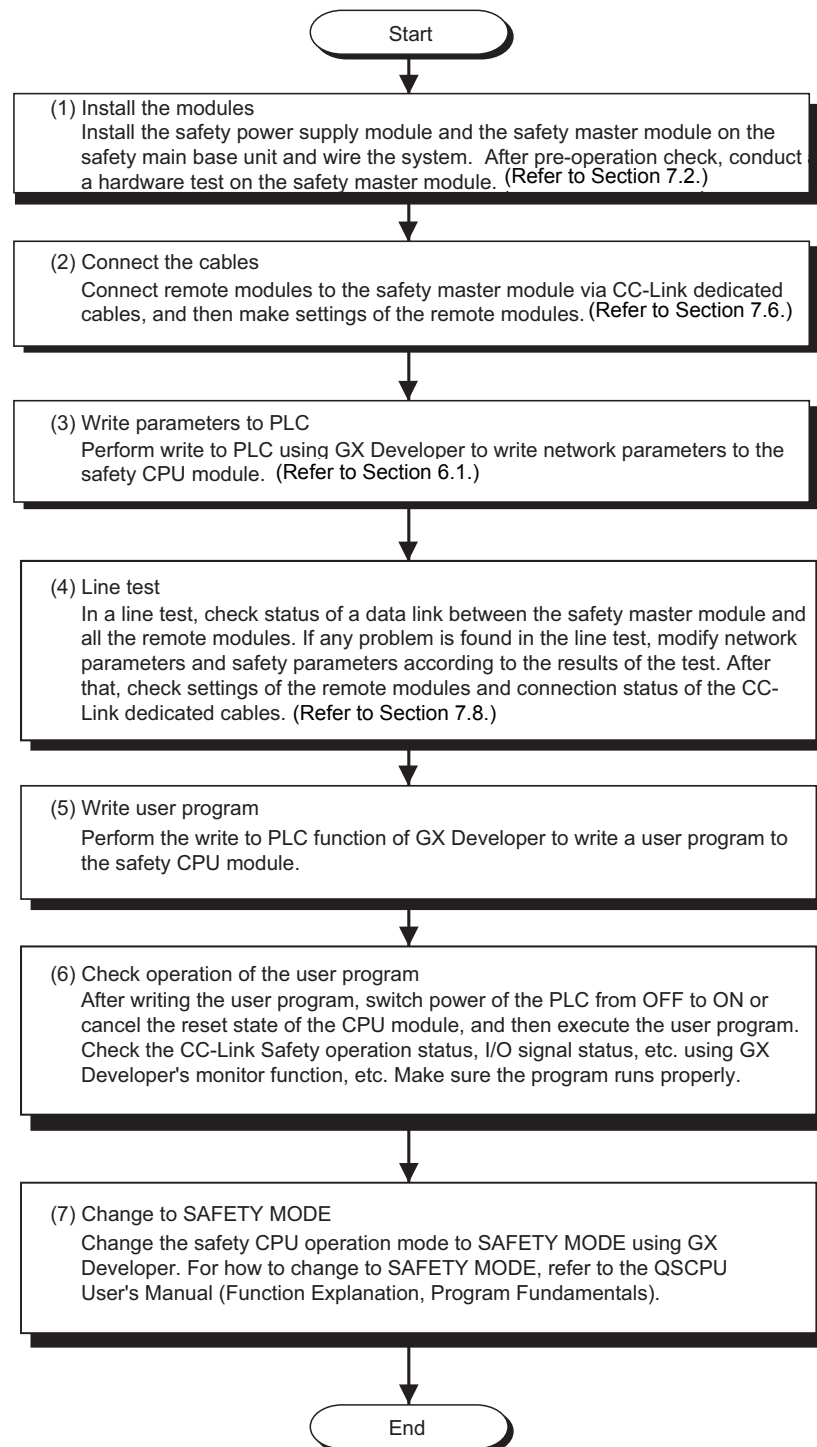

7.2 Module Installation Procedure

The following describes the procedure from the module installation to the operation check of the safety master module.

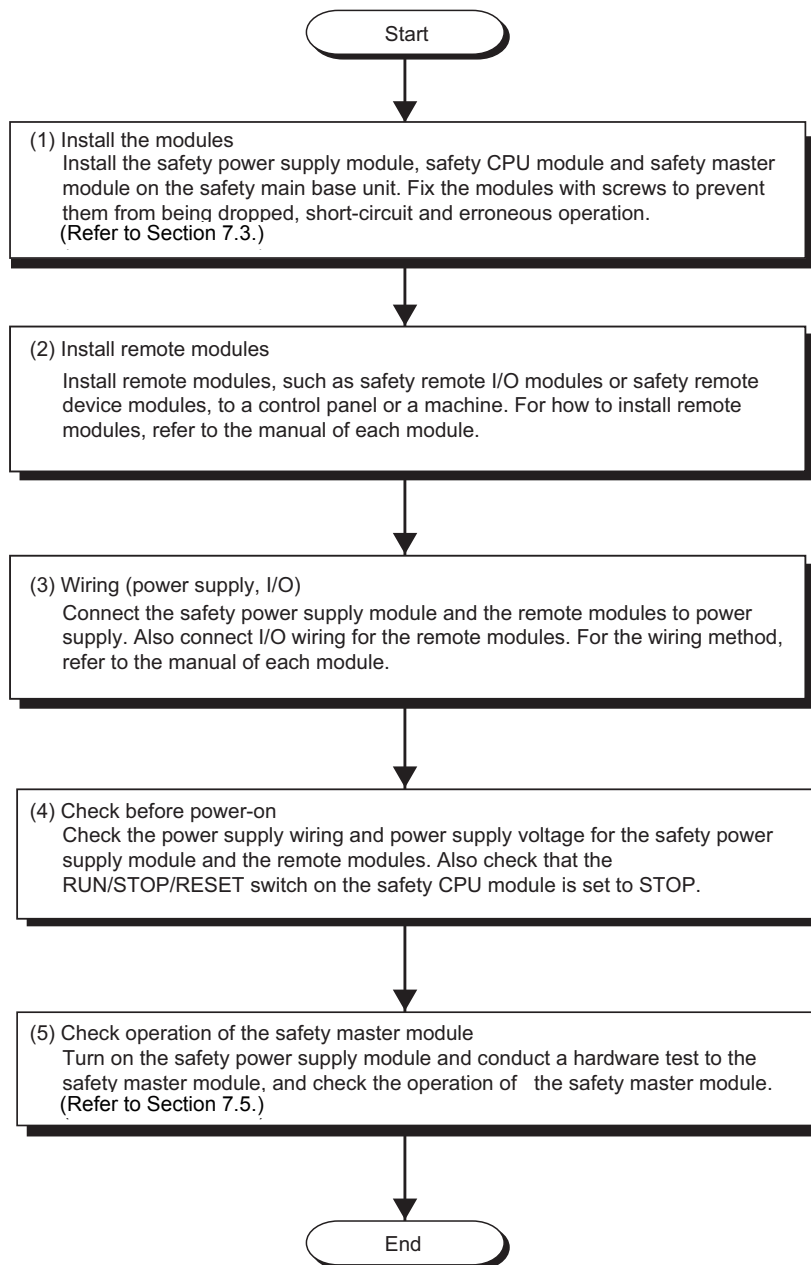

7.3 Mounting and Installation

Handling precautions to be taken from when unpacking the safety master module until its installation are described below.

For details on implementation and installation of the module, refer to the "QSCPU User's Manual (Hardware Design, Maintenance and Inspection)."

7.3.1 Handling Precautions

- (1) Since the module case is made of resin, do not drop it or apply strong impacts on it.
- (2) Do not remove the PCB of each module from its case. This may cause a failure in the module.
- (3) Be careful not to let foreign matter such as wire offcuts enter the module during wiring. If any foreign matter has entered, remove it immediately. Otherwise, it may cause a fire, failure or malfunction.
- (4) The top surface of the module is covered with an ingress prevention label film to prevent foreign matter such as wire offcuts from entering the module during wiring. Do not remove this label until the wiring is complete. Before operating the system, be sure to remove the label to allow adequate heat dissipation.
- (5) Crimp terminals with insulated sleeves cannot be used with the terminal block. Covering the wiring parts for the crimp terminals with mark tubes or insulated tubes is recommended.
- (6) Always touch a grounded metal to discharge the static electricity charged in the human body before handling the module. Failure to do so may cause a failure or malfunctions of the module.
- (7) Tighten the module mounting screws within the following ranges.

Screw name	Tightening torque range
Module mounting screw (M3 screw)	0.36 to 0.48N · m
Terminal block terminal screw (M3 screw)	0.42 to 0.58N · m
Terminal block mounting screw (M3.5 screw)	0.66 to 0.89N · m

- (8) To mount the module on a base unit, fully insert the module fixing tab into the fixing hole in the base unit and press the module into position. Be sure to tighten the module mounting screws within the specified tightening torque range. Improper installation may result in malfunction, failure, or drop of the module.

☒ POINT

- (1) Always turn the power of the corresponding station OFF before mounting or removing the terminal block. If it is mounted or removed without turning OFF the power, correct data transmission by the mounted or removed station will not be guaranteed.
- (2) Always power off the system in advance when removing the terminating resistor to change the system. If it is removed and mounted while the system is energized, correct data transmission will not be guaranteed.

7.3.2 Installation Environment

For the installation environment, refer to the QSCPU User's Manual (Hardware Design, Maintenance and Inspection).

7.4 Part Names and Settings

This section explains the part names of the safety master module, together with the LED indications and the setting method of the switches.

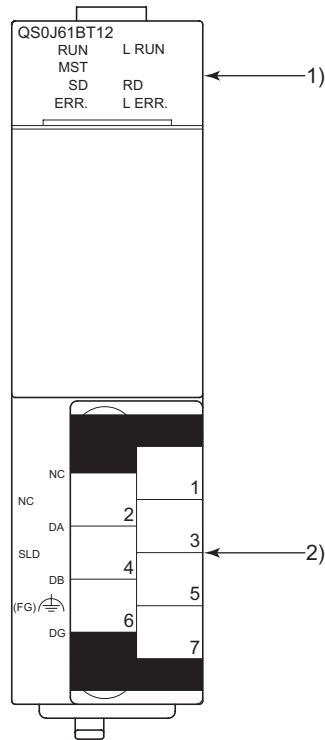

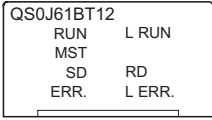
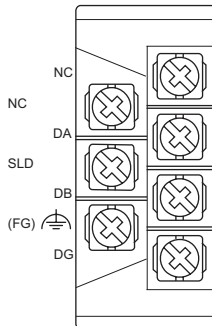
No.	Name	Details																
1)	LED indicators	Indicates the data link state by turning the LEDs ON or OFF.																
		<table border="1"> <thead> <tr> <th>LED name</th> <th>Details</th> </tr> </thead> <tbody> <tr> <td>RUN</td> <td>ON: Module is normal OFF: Watch dog timer error</td> </tr> <tr> <td>ERR.</td> <td>ON: Communication error in all stations Turns ON when the following type of error occurs. <ul style="list-style-type: none"> • When master station is overlapped on the same line • When there is an error in the parameter settings • When the data link monitor timer timed out • When the cable is disconnected, or the transmission route is being affected by noise, etc. To check the source of the error, see Section 9.4. Or, see Section 8.3.2 for details regarding SW0058 (detailed LED display status) Flicker: A communication error station identified, or remote station No. overlapped. </td> </tr> <tr> <td>MST</td> <td>ON: Operating as master station (during data link control)</td> </tr> <tr> <td>L RUN</td> <td>ON: Executing data link</td> </tr> <tr> <td>L ERR.</td> <td>ON: Communication error (host) Flickering of inconsistent intervals: The terminating resistor is not attached. Or, the module and CC-Link dedicated cable are affected by noise.</td> </tr> <tr> <td>SD</td> <td>ON: Sending data</td> </tr> <tr> <td>RD</td> <td>ON: Receiving data</td> </tr> </tbody> </table>	LED name	Details	RUN	ON: Module is normal OFF: Watch dog timer error	ERR.	ON: Communication error in all stations Turns ON when the following type of error occurs. <ul style="list-style-type: none"> • When master station is overlapped on the same line • When there is an error in the parameter settings • When the data link monitor timer timed out • When the cable is disconnected, or the transmission route is being affected by noise, etc. To check the source of the error, see Section 9.4. Or, see Section 8.3.2 for details regarding SW0058 (detailed LED display status) Flicker: A communication error station identified, or remote station No. overlapped.	MST	ON: Operating as master station (during data link control)	L RUN	ON: Executing data link	L ERR.	ON: Communication error (host) Flickering of inconsistent intervals: The terminating resistor is not attached. Or, the module and CC-Link dedicated cable are affected by noise.	SD	ON: Sending data	RD	ON: Receiving data
	LED name	Details																
	RUN	ON: Module is normal OFF: Watch dog timer error																
	ERR.	ON: Communication error in all stations Turns ON when the following type of error occurs. <ul style="list-style-type: none"> • When master station is overlapped on the same line • When there is an error in the parameter settings • When the data link monitor timer timed out • When the cable is disconnected, or the transmission route is being affected by noise, etc. To check the source of the error, see Section 9.4. Or, see Section 8.3.2 for details regarding SW0058 (detailed LED display status) Flicker: A communication error station identified, or remote station No. overlapped.																
	MST	ON: Operating as master station (during data link control)																
	L RUN	ON: Executing data link																
	L ERR.	ON: Communication error (host) Flickering of inconsistent intervals: The terminating resistor is not attached. Or, the module and CC-Link dedicated cable are affected by noise.																
	SD	ON: Sending data																
RD	ON: Receiving data																	
																		
2)	Terminal block																	
		<p>Connect the CC-Link dedicated cable for the data link. Refer to Section 7.6 for details on the connection methods. The terminals SLD and FG are connected inside the module. This is a 2-piece terminal block, and the module can be replaced without disconnecting the signal wires connected to the terminal block. (Replace the module after turning its power OFF.)</p>																

7.5 Checking the Module Status (Hardware Test)

The hardware test checks whether or not each module works properly by itself. Always perform this hardware test before configuring the system and for each module by itself without connecting the cable. Otherwise, the hardware test will not be executed properly. "CC-LINK PARAMETER ERROR" occurs when a hardware test is executed in a safety CPU operation mode other than TEST MODE.

Execute the hardware test using the following procedure.

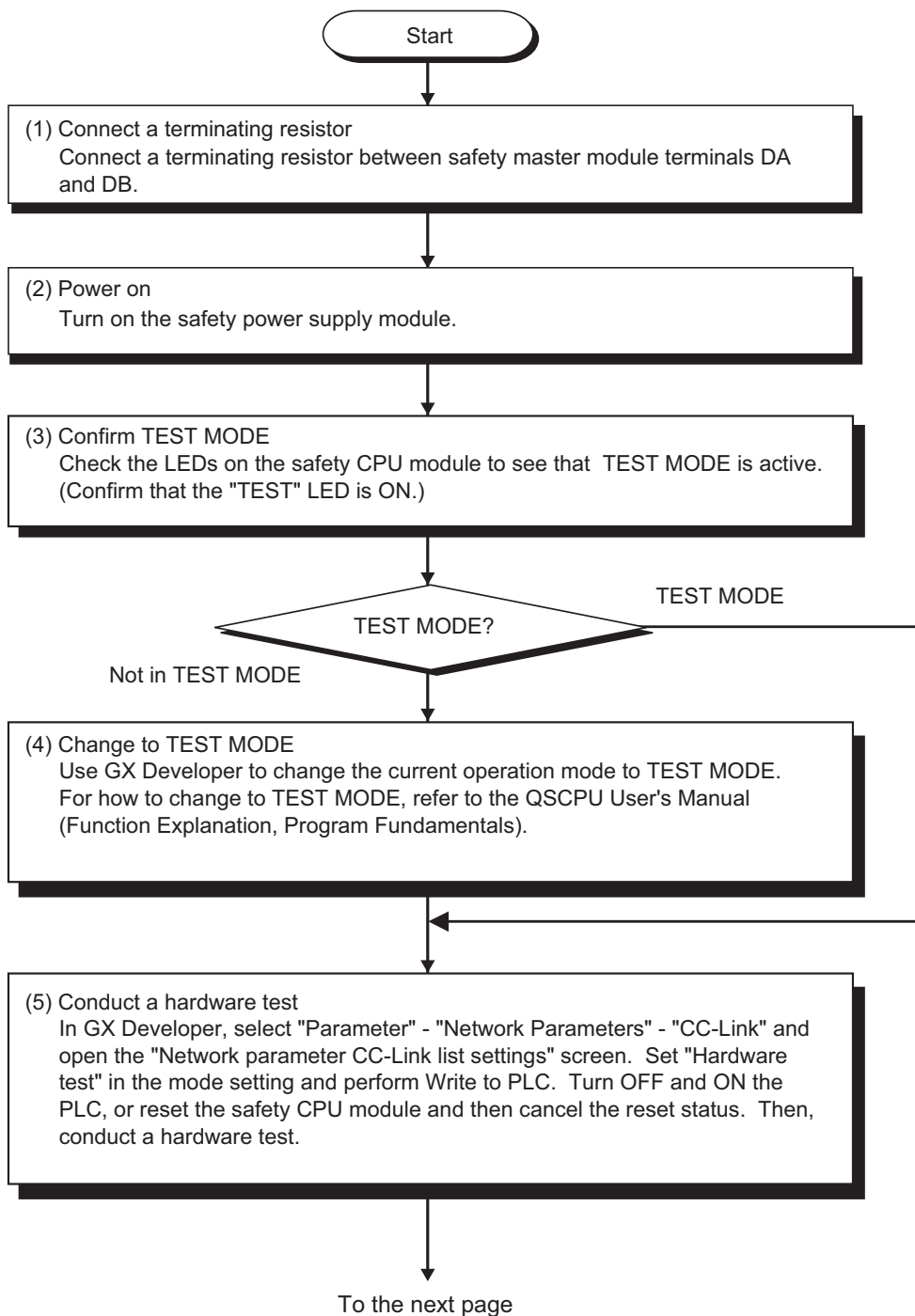

7 PROCEDURE BEFORE STARTING THE DATA LINK

From the previous page

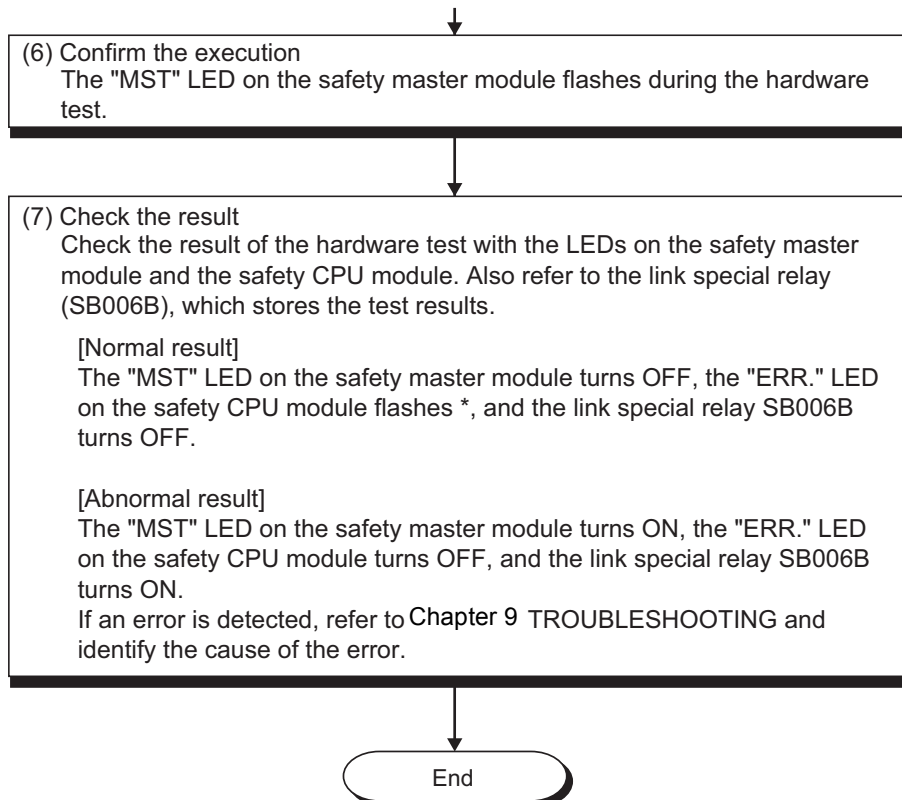

* If the hardware test is completed normally, the safety master module enters the watchdog timer error state. Accordingly, "INTELLIGENT FUNCTION MODULE DOWN" (error code 1403) is generated on the safety CPU module.

7.6 CC-Link Dedicated Cable Wiring

This section explains how to connect the safety master module, safety remote I/O module, standard remote I/O module and/or remote device module with CC-Link dedicated cables.

- (1) The cable connecting sequence is not related with the station No.
- (2) Be sure to connect the "terminating resistors" compatible with the cable type to the modules on both ends of the CC-Link Safety system. Connect each terminating resistor between "DA" and "DB".
- (3) In the CC-Link Safety system, the terminating resistor to be used is different depending on the applied cable.

Cable type	Terminating resistor
Version 1.10 compatible CC-Link dedicated cable	110Ω 1/2 W*
CC-Link dedicated cable (Ver.1.00)	(brown-brown-brown)
CC-Link dedicated high-performance cable	130Ω 1/2 W (brown-orange-brown)

* This resistors are enclosed with QS0J61BT12

- (4) The safety master module can be connected to any location other than both ends.
- (5) Star topology is not allowed.
- (6) A connection method is shown below.

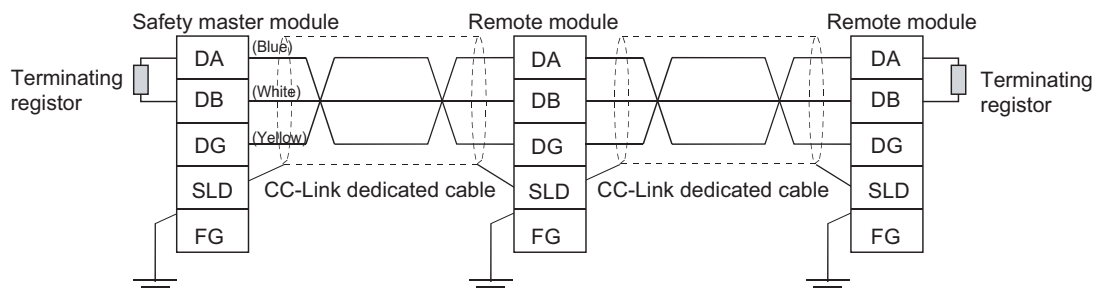

IMPORTANT

Each of the CC-Link dedicated cables (for Ver.1.10, Ver.1.00, and high-performance cables) cannot be used together with another type of cable. If used together, correct data transmission will not be guaranteed.

POINT

Connect the shielded wire of the CC-Link dedicated cable to "SLD" of each module, and ground the both ends of the shielded wire via "FG". The SLD and FG are connected in the module.

7.7 T-Branch Connection with the CC-Link Dedicated Cable

This section explains how to perform a T-branch connection using the CC-Link dedicated cable.

7.7.1 T-Branch system configuration

The following shows a system configuration using T-branch connection.

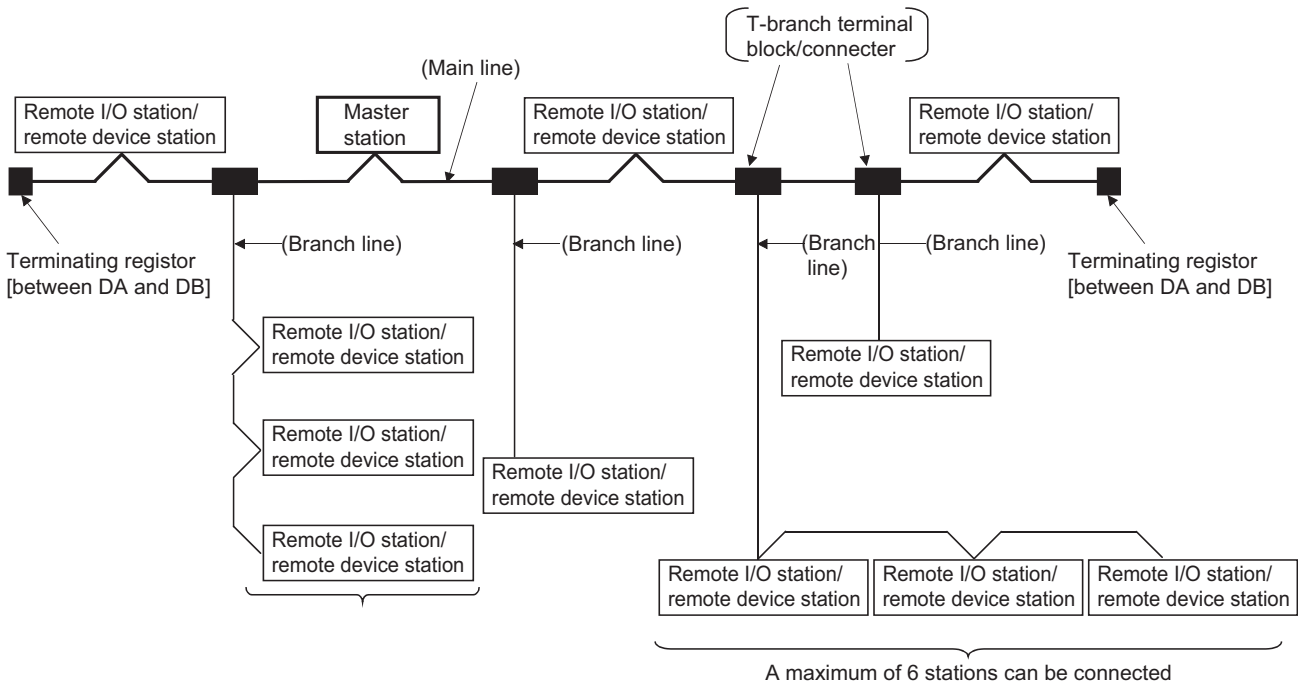

* The number of branch lines is determined by the branch line length per branch line and the overall branch line length.

7.7.2 T-Branch communication specifications list

The following describes the communication specifications for T branch connection. For communication specifications not listed below, see Section 3.1.

Item	Specification		Remarks		
Transmission speed	625kbps	156kbps	For 10, 5, or 2.5Mbps, form T-branching using repeaters.		
Maximum length of the main line	100m (328.1 ft.)	500m (1640.5 ft.)	Indicates the length of the cable between terminating resistors. The length of the T branch cable (branch line length) is not included.		
Maximum length of the branch line	8m(26.25 ft.)		Indicates the overall cable length per branch.		
Overall branch line length	50 m (164.05 ft.)	200 m (656.2 ft.)	Indicates the overall length of the entire branch cable.		
Maximum number of connected stations on the branch line	6 stations per branch		The total number of connected stations depends on the CC-Link specifications.		
Connection cable	<ul style="list-style-type: none"> Ver.1.10 compatible CC-Link dedicated cable CC-Link dedicated cable 		<ul style="list-style-type: none"> Mixing of different brands of Ver. 1.10 compatible CC-Link dedicated cables is allowed. Mixing of different brands of CC-Link dedicated cables is not allowed. The CC-Link dedicated high-performance cable cannot be used. 		
T branch terminal block/connector	<ul style="list-style-type: none"> Terminal block: Off-the-shelf terminal block Connector: FA sensor connector equivalent to ICE947-5-2 is recommended. 		<ul style="list-style-type: none"> When wiring cables for the main line side, try not to remove the covering as much as possible. 		
Maximum length of main line, distance between T branches, and length of cable between stations	Ver.1.10 compatible CC-Link dedicated cable, CC-Link dedicated cable (uses 110 W terminating resistor)				
	Transmission speed	Maximum length of main line	Distance between T branches	Length of cable between the remote I/O stations or remote device stations *1	Length of cable between the safety master station and the pervious/next station *2
	625kbps	100 m (328.1 ft.)	No limit	30 cm (11.8 in.) or longer	1m or longer
156kbps	500 m (1640.5 ft.)				

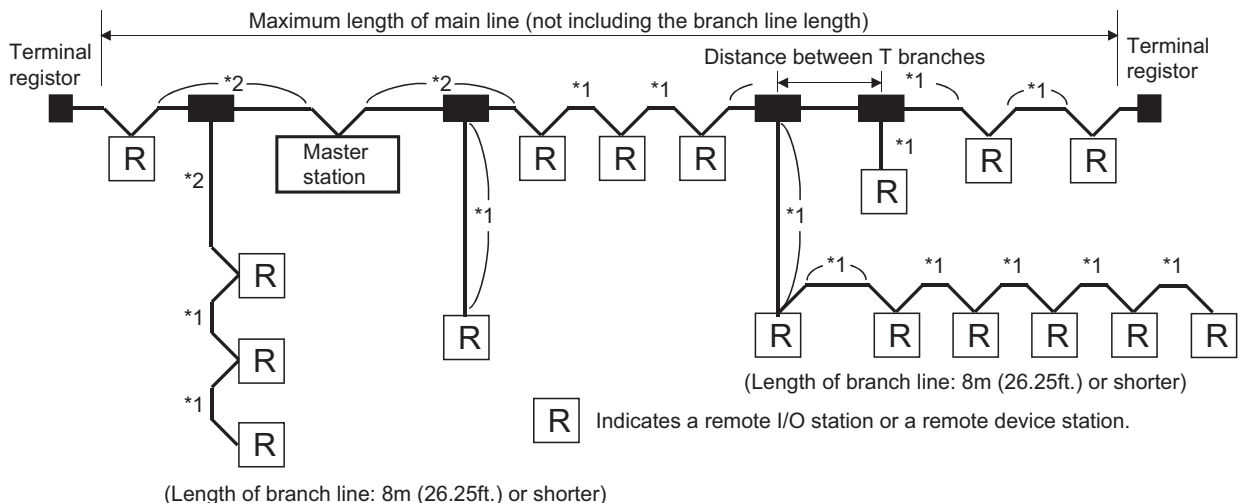

7.8 Checking the Connection Status (Line Test)

After connecting all the modules with CC-Link dedicated cables, check if the safety remote I/O stations, standard remote I/O stations and remote device stations are correctly connected and if a data link is established between them.

Line test 1 checks the status of communication with all modules that have been connected.

Line test 2 checks the status of communication with specific modules.

Perform the line test according to the following procedure.

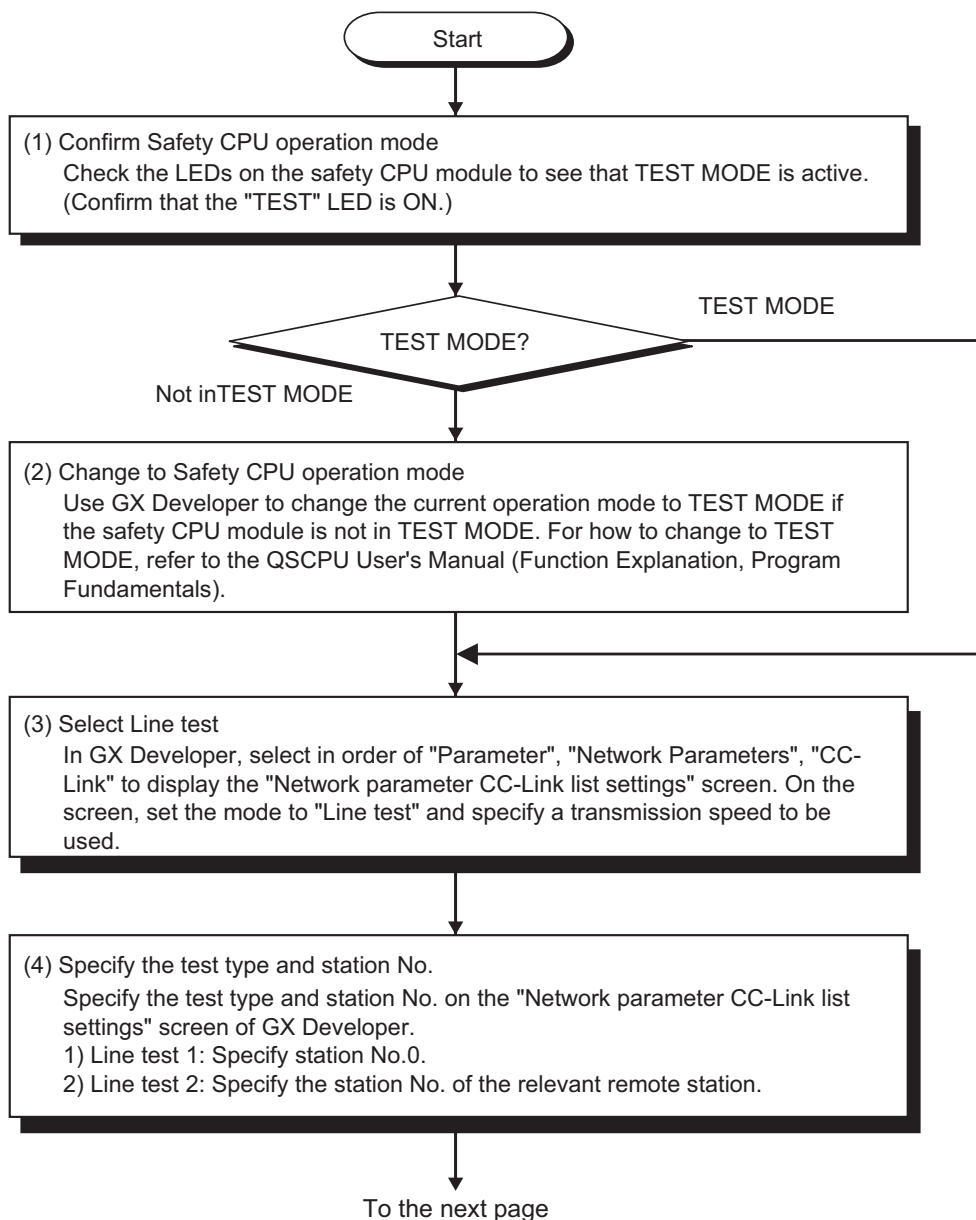

7 PROCEDURE BEFORE STARTING THE DATA LINK

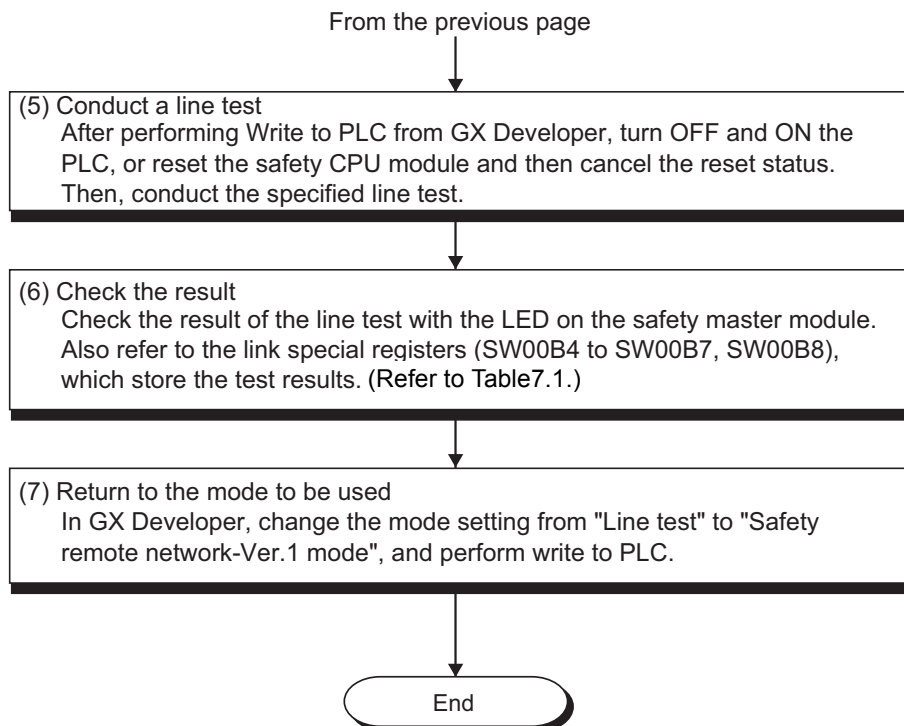

Table7.1 LED indications and link special register states at the line test completion

Line test type	Status	LEDs on safety master module	Results of line test 1 (SW00B4 to SW00B7 (6B4H to 6B7H))	Line test result (SW00B8 (6B8H))
Line test 1	Response present	"MST" LED : Flashing "ERR." LED : OFF "L RUN" LED : ON	All OFF (All stations are normal.) Partially OFF (Some stations are normal.) (Station No. data of the stations that received responses are updated.)	0: Normal
	No response	"MST" LED : ON "ERR." LED : Flashing "L RUN" LED : OFF	All ON (All stations are abnormal.) (Station No. data of the stations that received responses are updated.)	Other than 0 : Error code (BA1B) is stored.
Line test 2	Normal	"MST" LED : Flashing "ERR." LED : OFF "L RUN" LED : ON	—	0: Normal
	Abnormal	"MST" LED : ON "ERR." LED : Flashing "L RUN" LED : OFF	—	Other than 0 : Error code (BA19) is stored.

CHAPTER8 PROGRAMMING SPECIFICATIONS

This chapter explains the specifications involving programming.

For explanations of special relays (SM) and special registers (SD) of the safety CPU module, refer to QSCPU User's Manual (Function Explanation · Program Fundamentals).

8.1 I/O Signals used for Safety CPU Module

This section explains I/O signals used between the safety master module and the safety CPU module.

8.1.1 I/O signal list

Table8.1 shows a list of the I/O signals.

The character "n" in the table indicates the head I/O number of the safety master module and it depends on the module installation position and the module which is installed before the master module.

<Example> When the head I/O number of the safety master module is "X/Y20"

Xn0 to X (n + 1) F → X20 to X3F

Yn0 to Y (n + 1) F → Y20 to Y3F

Table8.1 I/O signal list

Signal direction: Safety CPU module ← Safety master module		Signal direction: Safety CPU module → Safety master module		
Input number	Signal name	Output number	Signal name	
Xn0	Module error	Yn0		
Xn1	Host data link status	Yn1		
Xn2	Use prohibited	Yn2		
Xn3	Other station data link status	Yn3		
Xn4	Use prohibited	Yn4		
Xn5		Yn5		
Xn6		Yn6		
Xn7		Yn7		
Xn8		Yn8		
Xn9		Yn9		
XnA		YnA		
XnB		YnB		
XnC		YnC		
XnD		YnD		
XnE		YnE		
XnF		Module ready	YnF	Use prohibited
X(n+1)0		Use prohibited	Y(n+1)0	
X(n+1)1			Y(n+1)1	
X(n+1)2			Y(n+1)2	
X(n+1)3			Y(n+1)3	
X(n+1)4	Y(n+1)4			
X(n+1)5	Y(n+1)5			
X(n+1)6	Y(n+1)6			
X(n+1)7	Y(n+1)7			
X(n+1)8	Y(n+1)8			
X(n+1)9	Y(n+1)9			
X(n+1)A	Y(n+1)A			
X(n+1)B	Y(n+1)B			
X(n+1)C	Y(n+1)C			
X(n+1)D	Y(n+1)D			
X(n+1)E	Y(n+1)E			
X(n+1)F	Y(n+1)F			

IMPORTANT

- (1) The input signals of the safety master module cannot be used in programs created for safety equipment control because they are not safety information.
- (2) The output signals are used by the system and use of them is not allowed for the user. If any of them is used (turned on/off) by the user, normal operations cannot be guaranteed.

8.1.2 Details of input signals

The following explains the on/off timings and conditions of the input signals shown in Table 8.1:

(1) Module error: Xn0

This signal indicates whether the module is normal or faulty.

OFF : Module normal

ON : Module error

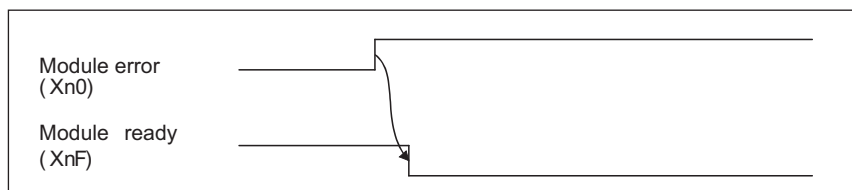

(2) Host data link status: Xn1

This signal indicates the data link status of the host station.

OFF : Data link is stopped

ON : Data linking in progress

(3) Other station data link status: Xn3

This signal indicates data link status of other stations (safety remote I/O stations, standard remote I/O stations and remote device stations).

The SB0080 signal has the same contents.

OFF : All stations normal

ON : There is a faulty station (The faulty station status data is stored in SW0080 to SW0083)

☒ POINT

It takes up to 6 seconds from when a slave station error is identified in the safety master station until the Other station data link status (Xn3) turns ON.

The time spent to turn it ON varies depending on the system configuration and the error status.

(4) Module ready: XnF

This signal indicates whether the module is ready to operate.

- (a) When the module reaches ready-to-operate status, this signal turns ON automatically.
- (b) This signal turns OFF when either of the following conditions occurs:
 - 1) When an error is detected in the switch setting of the module
 - 2) When the module error signal (Xn0) turns ON

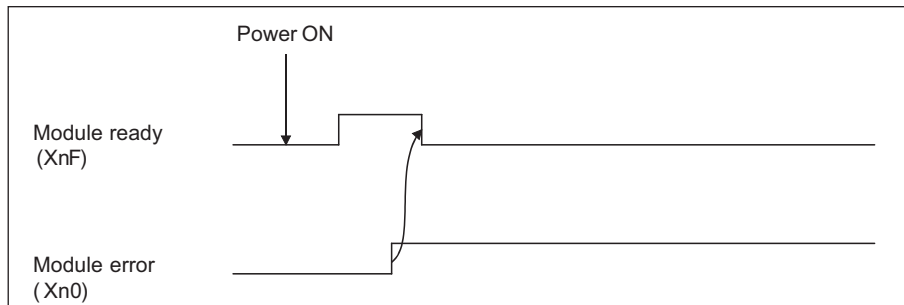

8.2 Buffer Memory

The buffer memory is used for data transfer between the safety master module and safety CPU module.

Data are stored in the Parameter information area and I/O data (RX, RY, RWr, RWw) are auto-refreshed to CPU devices according to the parameter settings written to the PLC.

The following buffer memory addresses are used for monitoring or device testing in GX Developer.

The contents of the buffer memory return to the default when the power is switched from OFF to ON or a reset state of the safety CPU module is canceled.

8.2.1 Buffer memory list

The buffer memory list is shown in Table8.2.

Table8.2 Buffer Memory List

Address		Item	Description	Read/Write	Reference section
Hexadecimal	Decimal				
0H to DFH	0 to 223	Parameter information area	Stores the parameter settings.	Read only	Section 8.2.2 (1)
E0H to 15FH	224 to 351	Remote input (RX)	Stores the status of inputs from safety remote I/O stations, standard remote I/O stations and remote device stations.	Read only	Section 8.2.2 (2)
160H to 1DFH	352 to 479	Remote output (RY)	Stores the status of outputs to safety remote I/O stations, standard remote I/O stations and remote device stations.	Write only	
1E0H to 2DFH	480 to 735	Remote register (RWw)	Stores the send data to remote device stations.	Write only	Section 8.2.2 (3)
2E0H to 3DFH	736 to 991	Remote register (RWr)	Stores the receive data from remote device stations.	Read only	
3E0H to 5DFH	992 to 1503	Slave station offset, size information	Stores the offset and size of RX/RY/RWw/RWr for each remote station.	Read only	Section 8.2.2 (4)
5E0H to 5FFH	1504 to 1535	Link special relay (SB)	Stores the data link status.	Read/write enabled (write may be disabled depending on the device)	Section 8.2.2 (5)
600H to 7FFH	1536 to 2047	Link special register (SW)	Stores the data link status.		Section 8.2.2 (6)
800H to 7FFFH	2048 to 32767	Use prohibited	---	---	---

8.2.2 Buffer memory details

The following explains the details of the items shown in Table8.2, "Buffer Memory List" in Section 8.3.1.

(1) Parameter information area

This area stores the parameter settings that were written from GX Developer to the PLC. For the setting details, refer to CHAPTER 6.

Table8.3 Parameter Information Area List (1/2)

Address		Item	Description	Data range	Default value
Hex.	Dec.				
0H	0	(Use prohibited)	---	---	---
1H	1	Number of connected modules	Stores the number of safety remote I/O stations, standard remote I/O stations and remote device stations that are connected to the safety master station. (including reserved stations)	1 to 64 (modules)	64 (modules)
2H	2	Number of retries	Stores the number of retries to be performed to a communication error station.	1 to 7 (times)	3 (times)
3H	3	Number of automatic return modules	Stores the number of safety remote I/O stations, standard remote I/O stations and remote device stations that can rejoin the network in one link scan.	1 to 10 (modules)	1 (module)
4H	4	Standby master station specification	Stores the station number of the standby master station.	0: No standby master station specified (Fixed)	0
5H	5	(Use prohibited)	---	---	---
6H	6	Safety CPU down select	Stores a value of the data link status specified for when a safety CPU module error occurs on the safety master station.	0 (Stop) (Fixed)	0
7H	7	Scan mode setting	Stores data showing whether the link scan is synchronous with the sequence scan or not.	1 (Synchronous) (Fixed)	1
8H	8	Delay information setting	Set 0 for the delay time.	0: Not specified (Fixed)	0
9H to FH	9 to 15	(Use prohibited)	---	---	---
10H to 13H	16 to 19	Reserved station specification	Stores the reserved station data.	Bit corresponding to the station number turns on.	0 (Not specified)
14H to 17H	20 to 23	Error invalid station specification	Stores the error invalid station data.	0: Not specified (Fixed)	0
18H to 1FH	24 to 31	(Use prohibited)	---	---	---

Table8.3 Parameter Information Area List (2/2)

Address		Item	Description	Data range	Default value																																																		
Hex.	Dec.																																																						
20 _H to 5F _H	32 to 95	Station information	Stores the set data of the connected remote I/O stations and remote device stations. Address 20 _H : 1st station to Address 5F _H : 64th station		0101 _H (Remote I/O station, Occupies 1 station, Station No.1) to 0140 _H (Remote I/O station, Occupies 1 station, Station No.64)																																																		
60 _H to 63 _H	96 to 99	Specification of safety remote station	Stores the data of the specified safety remote station.	Bit corresponding to the station No. turns ON. 0: Standard remote station 1: Safety remote station <table border="1"> <thead> <tr> <th></th> <th>b15</th> <th>b14</th> <th>b13</th> <th>b12</th> <th>to</th> <th>b3</th> <th>b2</th> <th>b1</th> <th>b0</th> </tr> </thead> <tbody> <tr> <td>60_H</td> <td>16</td> <td>15</td> <td>14</td> <td>13</td> <td>to</td> <td>4</td> <td>3</td> <td>2</td> <td>1</td> </tr> <tr> <td>61_H</td> <td>32</td> <td>31</td> <td>30</td> <td>29</td> <td>to</td> <td>20</td> <td>19</td> <td>18</td> <td>17</td> </tr> <tr> <td>62_H</td> <td>48</td> <td>47</td> <td>46</td> <td>45</td> <td>to</td> <td>36</td> <td>35</td> <td>34</td> <td>33</td> </tr> <tr> <td>63_H</td> <td>64</td> <td>63</td> <td>62</td> <td>61</td> <td>to</td> <td>52</td> <td>51</td> <td>50</td> <td>49</td> </tr> </tbody> </table> Numbers 1 to 64 in the above table indicate the station numbers.		b15	b14	b13	b12	to	b3	b2	b1	b0	60 _H	16	15	14	13	to	4	3	2	1	61 _H	32	31	30	29	to	20	19	18	17	62 _H	48	47	46	45	to	36	35	34	33	63 _H	64	63	62	61	to	52	51	50	49	0 (No setting)
	b15	b14	b13	b12	to	b3	b2	b1	b0																																														
60 _H	16	15	14	13	to	4	3	2	1																																														
61 _H	32	31	30	29	to	20	19	18	17																																														
62 _H	48	47	46	45	to	36	35	34	33																																														
63 _H	64	63	62	61	to	52	51	50	49																																														
64 _H to DF _H	100 to 223	(Use prohibited)	---	---	---																																																		

(2) Remote input (RX) and remote output (RY)

(a) Safety master station ← Safety remote I/O station/standard remote I/O station/remote device station

1) Safety master station

- The data input from safety remote I/O stations, standard remote I/O stations and/or remote device stations are stored.
- An area of 2 words are allocated to each station. The refresh target CPU devices are specified on the parameter setting screen of GX Developer. For the setting details, refer to CHAPTER 6.

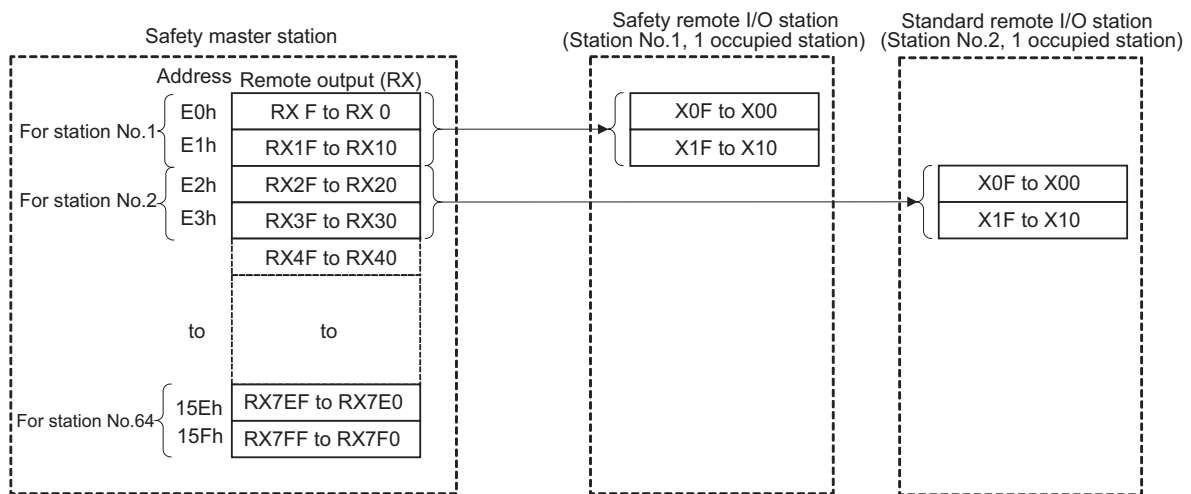

The following tables show the station numbers and corresponding buffer-memory addresses.

Table of station numbers and corresponding buffer memory addresses

Station number	Buffer memory address	Station number	Buffer memory address	Station number	Buffer memory address	Station number	Buffer memory address	Station number	Buffer memory address
1	E0H to E1H	14	FAH to FBH	27	114H to 115H	40	12EH to 12FH	53	148H to 149H
2	E2H to E3H	15	FBH to FDH	28	116H to 117H	41	130H to 131H	54	14AH to 14BH
3	E4H to E5H	16	FEH to FFH	29	118H to 119H	42	132H to 133H	55	14CH to 14DH
4	E6H to E7H	17	100H to 101H	30	11AH to 11BH	43	134H to 135H	56	14EH to 14FH
5	E8H to E9H	18	102H to 103H	31	11CH to 11DH	44	136H to 137H	57	150H to 151H
6	EAH to EBH	19	104H to 105H	32	11EH to 11FH	45	138H to 139H	58	152H to 153H
7	ECH to EDH	20	106H to 107H	33	120H to 121H	46	13AH to 13BH	59	154H to 155H
8	EEH to EFH	21	108H to 109H	34	122H to 123H	47	13CH to 13DH	60	156H to 157H
9	F0H to F1H	22	10AH to 10BH	35	124H to 125H	48	13EH to 13FH	61	158H to 159H
10	F2H to F3H	23	10CH to 10DH	36	126H to 127H	49	140H to 141H	62	15AH to 15BH
11	F4H to F5H	24	10EH to 10FH	37	128H to 129H	50	142H to 143H	63	15CH to 15DH
12	F6H to F7H	25	110H to 111H	38	12AH to 12BH	51	144H to 145H	64	15EH to 15FH
13	F8H to F9H	26	112H to 113H	39	12CH to 12DH	52	146H to 147H	---	---

(b) Safety master station → Safety remote I/O station/standard remote I/O station/
remote device station

1) Safety master station

- The data output to safety remote I/O stations, standard remote I/O stations and/or remote device stations are stored.
- An area of 2 words are allocated to each station. The refresh source CPU devices are specified on the parameter setting screen of GX Developer. For the setting details, refer to CHAPTER 6.

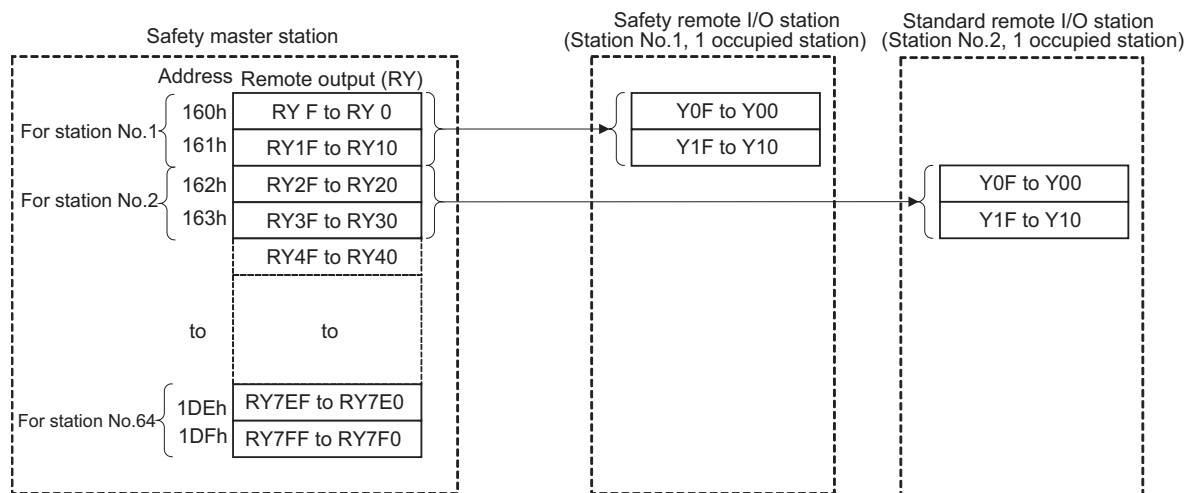

The following tables show the station numbers and corresponding buffer memory addresses.

Table of station numbers and corresponding buffer memory addresses

Station number	Buffer memory address	Station number	Buffer memory address	Station number	Buffer memory address	Station number	Buffer memory address	Station number	Buffer memory address
1	160H to 161H	14	17AH to 17BH	27	194H to 195H	40	1AEH to 1AFH	53	1C8H to 1C9H
2	162H to 163H	15	17CH to 17DH	28	196H to 197H	41	1B0H to 1B1H	54	1CAH to 1CBH
3	164H to 165H	16	17EH to 17FH	29	198H to 199H	42	1B2H to 1B3H	55	1CCH to 1CDH
4	166H to 167H	17	180H to 181H	30	19AH to 19BH	43	1B4H to 1B5H	56	1CEH to 1CFH
5	168H to 169H	18	182H to 183H	31	19CH to 19DH	44	1B6H to 1B7H	57	1D0H to 1D1H
6	16AH to 16BH	19	184H to 185H	32	19EH to 19FH	45	1B8H to 1B9H	58	1D2H to 1D3H
7	16CH to 16DH	20	186H to 187H	33	1A0H to 1A1H	46	1BAH to 1BBH	59	1D4H to 1D5H
8	16EH to 16FH	21	188H to 189H	34	1A2H to 1A3H	47	1BCH to 1BDH	60	1D6H to 1D7H
9	170H to 171H	22	18AH to 18BH	35	1A4H to 1A5H	48	1BEH to 1BFH	61	1D8H to 1D9H
10	172H to 173H	23	18CH to 18DH	36	1A6H to 1A7H	49	1C0H to 1C1H	62	1DAH to 1DBH
11	174H to 175H	24	18EH to 18FH	37	1A8H to 1A9H	50	1C2H to 1C3H	63	1DCH to 1DDH
12	176H to 177H	25	190H to 191H	38	1AAH to 1ABH	51	1C4H to 1C5H	64	1DEH to 1DFH
13	178H to 179H	26	192H to 193H	39	1ACH to 1ADH	52	1C6H to 1C7H	---	---

(3) Remote registers (RWw and RWr)

(a) Safety master station (RWw) → Remote device station (RWw)

1) Safety master station

- The data to be sent to the remote register (RWw) of a remote device station are stored.
- An area of 4 words is allocated to each station. The refresh source CPU devices are specified on the parameter setting screen of GX Developer. For the setting details, refer to CHAPTER 6.

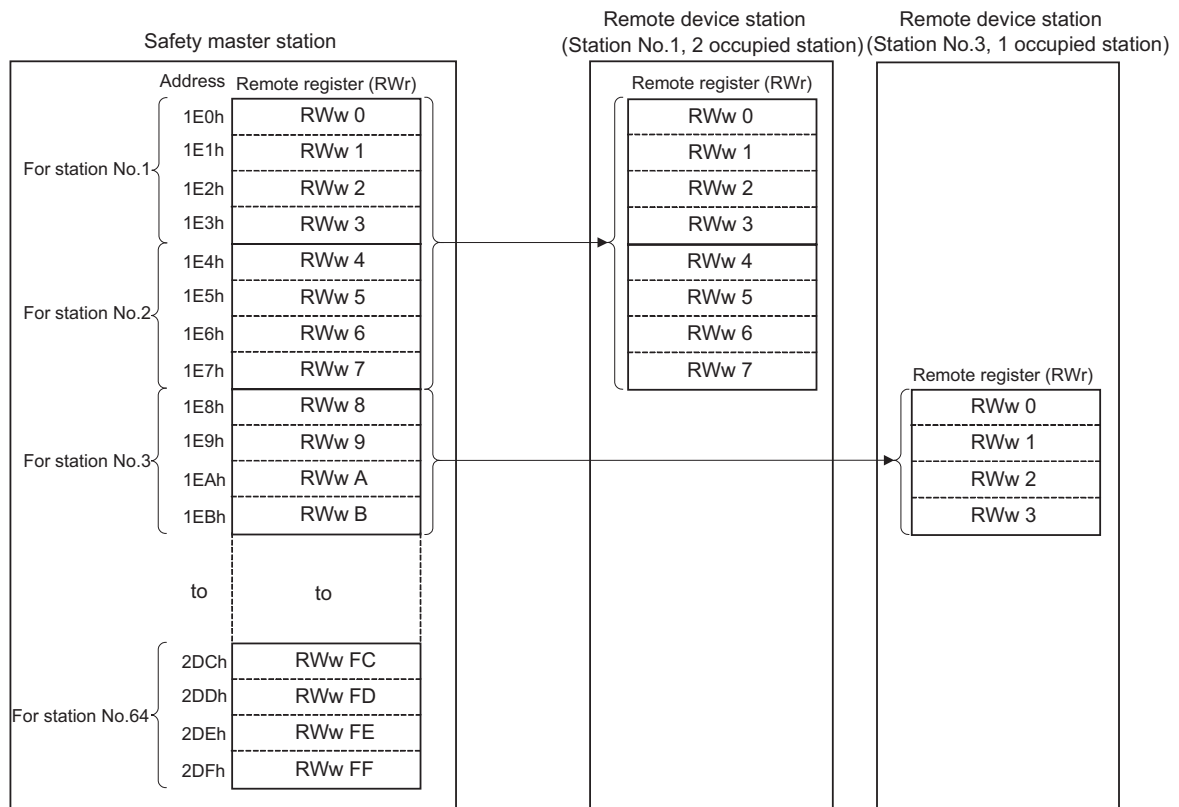

The following tables show the station numbers and corresponding buffer memory addresses.

Table of station numbers and corresponding buffer memory addresses

Station number	Buffer memory address	Station number	Buffer memory address	Station number	Buffer memory address	Station number	Buffer memory address	Station number	Buffer memory address
1	1E0H to 1E3H	14	214H to 217H	27	248H to 24BH	40	27CH to 27FH	53	2B0H to 2B3H
2	1E4H to 1E7H	15	218H to 21BH	28	24CH to 24FH	41	280H to 283H	54	2B4H to 2B7H
3	1E8H to 1EBH	16	21CH to 21FH	29	250H to 253H	42	284H to 287H	55	2B8H to 2BBH
4	1ECH to 1EFH	17	220H to 223H	30	254H to 257H	43	288H to 28BH	56	2BCH to 2BFH
5	1F0H to 1F3H	18	224H to 227H	31	258H to 25BH	44	28CH to 28FH	57	2C0H to 2C3H
6	1F4H to 1F7H	19	228H to 22BH	32	25CH to 25FH	45	290H to 293H	58	2C4H to 2C7H
7	1F8H to 1FBH	20	22CH to 22FH	33	260H to 263H	46	294H to 297H	59	2C8H to 2CBH
8	1FCH to 1FFH	21	230H to 233H	34	264H to 267H	47	298H to 29BH	60	2CCH to 2CFH
9	200H to 203H	22	234H to 237H	35	268H to 26BH	48	29CH to 29FH	61	2D0H to 2D3H
10	204H to 207H	23	238H to 23BH	36	26CH to 26FH	49	2A0H to 2A3H	62	2D4H to 2D7H
11	208H to 20BH	24	23CH to 23FH	37	270H to 273H	50	2A4H to 2A7H	63	2D8H to 2DBH
12	20CH to 20FH	25	240H to 243H	38	274H to 277H	51	2A8H to 2ABH	64	2DCH to 2DFH
13	210H to 213H	26	244H to 247H	39	278H to 27BH	52	2ACH to 2AFH	---	---

(b) Master station (RWr) ← Remote device station (RWr)

1) Safety master station

- The data to be sent from the remote register (RWr) of a remote device station are stored.
- An area of 4 words is allocated to each station. The refresh target CPU devices are specified on the parameter setting screen of GX Developer. For the setting details, refer to CHAPTER 6.

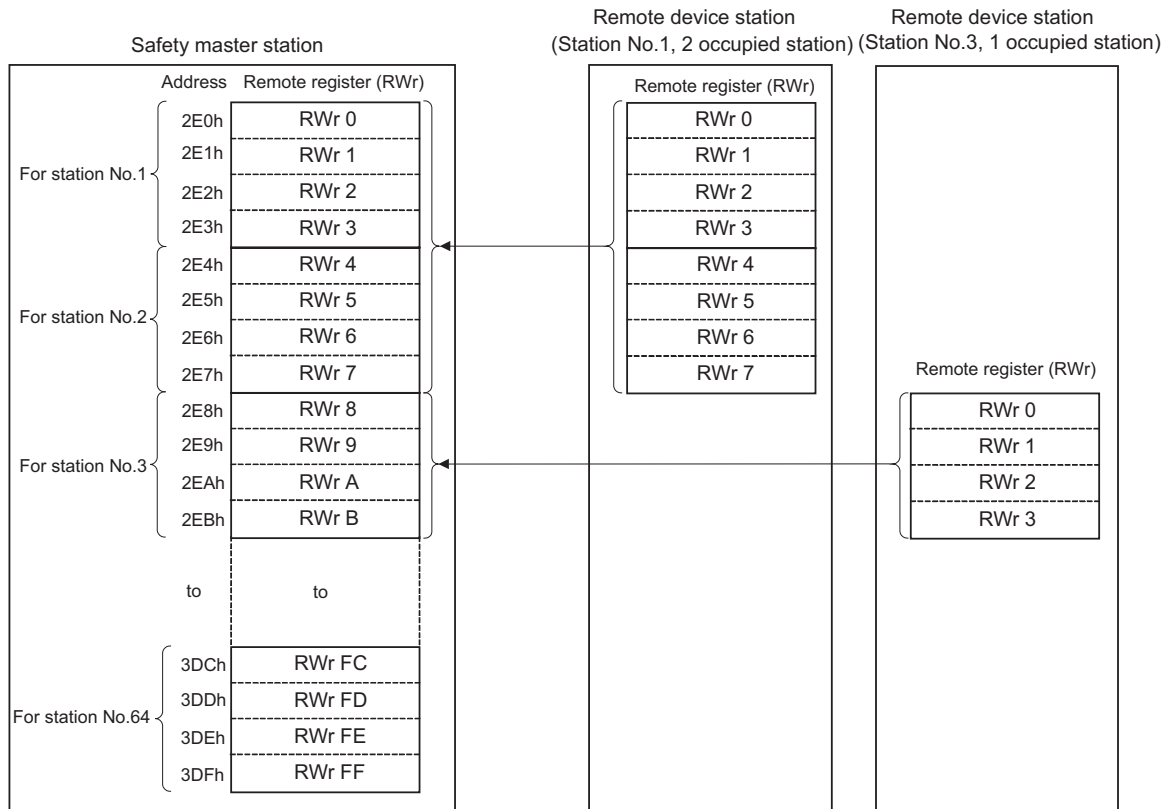

The following tables show the station numbers and corresponding buffer memory addresses. The Slave station offset, size information area is not auto-refreshed. For checking the data, use the monitoring function of GX Developer.

Table of station numbers and corresponding buffer memory addresses

Station number	Buffer memory address	Station number	Buffer memory address	Station number	Buffer memory address	Station number	Buffer memory address	Station number	Buffer memory address
1	2E0H to 2E3H	14	314H to 317H	27	348H to 34BH	40	37CH to 37FH	53	3B0H to 3B3H
2	2E4H to 2E7H	15	318H to 31BH	28	34CH to 34FH	41	380H to 383H	54	3B4H to 3B7H
3	2E8H to 2EBH	16	31CH to 31FH	29	350H to 353H	42	384H to 387H	55	3B8H to 3BBH
4	2ECH to 2EFH	17	320H to 323H	30	354H to 357H	43	388H to 38BH	56	3BCH to 3BFH
5	2F0H to 2F3H	18	324H to 327H	31	358H to 35BH	44	38CH to 38FH	57	3C0H to 3C3H
6	2F4H to 2F7H	19	328H to 32BH	32	35CH to 35FH	45	390H to 393H	58	3C4H to 3C7H
7	2F8H to 2FBH	20	32CH to 32FH	33	360H to 363H	46	394H to 397H	59	3C8H to 3CBH
8	2FCH to 2FFH	21	330H to 333H	34	364H to 367H	47	398H to 39BH	60	3CCH to 3CFH
9	300H to 303H	22	334H to 337H	35	368H to 36BH	48	39CH to 39FH	61	3D0H to 3D3H
10	304H to 307H	23	338H to 33BH	36	36CH to 36FH	49	3A0H to 3A3H	62	3D4H to 3D7H
11	308H to 30BH	24	33CH to 33FH	37	370H to 373H	50	3A4H to 3A7H	63	3D8H to 3DBH
12	30CH to 30FH	25	340H to 343H	38	374H to 377H	51	3A8H to 3ABH	64	3DCH to 3DFH
13	310H to 313H	26	344H to 347H	39	378H to 37BH	52	3ACH to 3AFH	---	---

(4) Slave station offset, size information

This area stores allocation data for RX/Ry/RWw/RWr to each station number.

"Table 8.4 Buffer Memory Address Mapping for Station Numbers and RX/Ry/RWw/RWr Offset and Size" shows the relation between buffer memory addresses and information to be stored.

(a) Offset

The head buffer memory address of RX/Ry/RWw/RWr that is allocated to each station is stored.

If two or more stations are occupied, a value is stored only in the head buffer address area of the station No.

(For example, if station No.1 occupies two stations, a value is stored only in the RX/Ry/RWw/RWr offset area of station No.1, and the RX/Ry/RWw/RWr offset area of station No.2 stores the head buffer memory address size of the corresponding area.)

(b) Size

The size of RX/Ry/RWw/RWr that is allocated to each station is stored in word units.

Any size less than 1 word is rounded to 1, and 1 is stored.

For a reserved station, 0000H is stored.

(For example, if station No.1 occupies two stations, a value is stored only to the RX/Ry/RWw/RWr size of station No.1, and the RX/Ry/RWw/RWr size of station No.2 stays at default value (0000H).

Table 8.4 Buffer Memory Address Mapping for Station Numbers and RX/RY/RWw/RWr Offset and Size

Buffer memory address		Item	Default (Hex.)
Hex.	Dec.		
3E0H	992	Station No. 1 RX offset	0000H
3E1H	993	Station No. 1 RX size	0000H
to	to	to	---
45EH	1118	Station No. 64 RX offset	0000H
45FH	1119	Station No. 64 RX size	0000H
460H	1120	Station No. 1 RY offset	0000H
461H	1121	Station No. 1 RY size	0000H
to	to	to	---
4DEH	1246	Station No. 64 RY offset	0000H
4DFH	1247	Station No. 64 RY size	0000H
4E0H	1248	Station No. 1 RWw offset	0000H
4E1H	1249	Station No. 1 RWw size	0000H
to	to	to	---
55EH	1374	Station No. 64 RWw offset	0000H
55FH	1375	Station No. 64 RWw size	0000H
560H	1376	Station No. 1 RWr offset	0000H
561H	1377	Station No. 1 RWr size	0000H
to	to	to	---
5DEH	1502	Station No. 64 RWr offset	0000H
5DFH	1503	Station No. 64 RWr size	0000H

(5) Link special relays (SB)

The link special relays store the data link status using bit ON/OFF data.

CPU devices to be refreshed are specified on the parameter setting screen of GX Developer.

For the setting details, refer to CHAPTER 6.

Buffer memory addresses 5E0H to 5FFH correspond to link special relays SB0000 to SB01FF.

For details on the link special relays (SB0000 to SB01FF), see Section 8.3.1.

The following table shows the relationship between buffer memory addresses 5E0H to 5FFH and link special relays SB0000 to SB01FF.

Address	b15	b14	b13	b12	b11	b10	b9	b8	b7	b6	b5	b4	b3	b2	b1	b0
5E0H	F	E	D	C	B	A	9	8	7	6	5	4	3	2	1	0
5E1H	1F	1E	1D	1C	1B	1A	19	18	17	16	15	14	13	12	11	10
5E2H	2F	2E	2D	2C	2B	2A	29	28	27	26	25	24	23	22	21	20
5E3H	3F	3E	3D	3C	3B	3A	39	38	37	36	35	34	33	32	31	30
5E4H	4F	4E	4D	4C	4B	4A	49	48	47	46	45	44	43	42	41	40
5E5H	5F	5E	5D	5C	5B	5A	59	58	57	56	55	54	53	52	51	50
5E6H	6F	6E	6D	6C	6B	6A	69	68	67	66	65	64	63	62	61	60
5E7H	7F	7E	7D	7C	7B	7A	79	78	77	76	75	74	73	72	71	70
5E8H	8F	8E	8D	8C	8B	8A	89	88	87	86	85	84	83	82	81	80
5E9H	9F	9E	9D	9C	9B	9A	99	98	97	96	95	94	93	92	91	90
5EAH	AF	AE	AD	AC	AB	AA	A9	A8	A7	A6	A5	A4	A3	A2	A1	A0
5EBH	BF	BE	BD	BC	BB	BA	B9	B8	B7	B6	B5	B4	B3	B2	B1	B0
5ECH	CF	CE	CD	CC	CB	CA	C9	C8	C7	C6	C5	C4	C3	C2	C1	C0
5EDH	DF	DE	DD	DC	DB	DA	D9	D8	D7	D6	D5	D4	D3	D2	D1	D0
5EEH	EF	EE	ED	EC	EB	EA	E9	E8	E7	E6	E5	E4	E3	E2	E1	E0
5EFH	FF	FE	FD	FC	FB	FA	F9	F8	F7	F6	F5	F4	F3	F2	F1	F0
5F0H	10F	10E	10D	10C	10B	10A	109	108	107	106	105	104	103	102	101	100
5F1H	11F	11E	11D	11C	11B	11A	119	118	117	116	115	114	113	112	111	110
5F2H	12F	12E	12D	12C	12B	12A	129	128	127	126	125	124	123	122	121	120
5F3H	13F	13E	13D	13C	13B	13A	139	138	137	136	135	134	133	132	131	130
5F4H	14F	14E	14D	14C	14B	14A	149	148	147	146	145	144	143	142	141	140
5F5H	15F	15E	15D	15C	15B	15A	159	158	157	156	155	154	153	152	151	150
5F6H	16F	16E	16D	16C	16B	16A	169	168	167	166	165	164	163	162	161	160
5F7H	17F	17E	17D	17C	17B	17A	179	178	177	176	175	174	173	172	171	170
5F8H	18F	18E	18D	18C	18B	18A	189	188	187	186	185	184	183	182	181	180
5F9H	19F	19E	19D	19C	19B	19A	199	198	197	196	195	194	193	192	191	190
5FAH	1AF	1AE	1AD	1AC	1AB	1AA	1A9	1A8	1A7	1A6	1A5	1A4	1A3	1A2	1A1	1A0
5FBH	1BF	1BE	1BD	1BC	1BB	1BA	1B9	1B8	1B7	1B6	1B5	1B4	1B3	1B2	1B1	1B0
5FCH	1CF	1CE	1CD	1CC	1CB	1CA	1C9	1C8	1C7	1C6	1C5	1C4	1C3	1C2	1C1	1C0
5FDH	1DF	1DE	1DD	1DC	1DB	1DA	1D9	1D8	1D7	1D6	1D5	1D4	1D3	1D2	1D1	1D0
5FEH	1EF	1EE	1ED	1EC	1EB	1EA	1E9	1E8	1E7	1E6	1E5	1E4	1E3	1E2	1E1	1E0
5FFH	1FF	1FE	1FD	1FC	1FB	1FA	1F9	1F8	1F7	1F6	1F5	1F4	1F3	1F2	1F1	1F0

(6) Link special registers (SW)

The link special registers store the data link status using word data.

CPU devices to be refreshed are specified on the parameter setting screen of GX Developer.

For the setting details, refer to CHAPTER 6.

Buffer memory addresses 600H to 7FFH correspond to link special registers SW0000 to SW01FF.

For more details on the link special registers (SW0000 to SW01FF), see Section 8.3.2.

8.3 Link Special Relays and Registers (SB/SW)

The data link status can be checked with bit data (link special relays: SB) and word data (link special registers: SW).

The SB and SW represent the information in the buffer memory of the safety master module, which are read into the devices specified with automatic refresh parameters for use. The applicability of them may vary depending on the safety CPU operation mode.

Example) When SB0200 and SW0200 are specified for SB and SW

respectively, refresh is performed as follows:

SB0000 to SB01FF → SB0200 to SB03FF

SW0000 to SW01FF → SW0200 to SW03FF

- Link special relays (SB) : Buffer memory addresses 5E0H to 5FFH
- Link special registers (SW): Buffer memory addresses 600H to 7FFH

IMPORTANT
(1) SB and SW of the safety master module are not safety information. They cannot be used in programs created to control safety equipment.
(2) Although SB and SW are stored in the buffer memory, they cannot be read or written directly. To read or write them, make the auto refresh setting.
(3) Do not write data to any SB/SW that is not specified in this section. Doing so may cause failure in data link.

8.3.1 Link special relays (SB)

Relays SB0000 to SB001F turn ON/OFF by a sequence program or the device test function of GX Developer, and SB0020 to SB01FF turn ON/OFF automatically. The values in parentheses in the number column indicate the buffer memory addresses.

Example) When the buffer memory address is 5E0H and the bit number is 8
5E0H, b8

For the correspondence with the buffer memory, see Section 8.2.2 (5).

Table 8.5 Link Special Relay List (1/3)

Number	Name	Description	Availability (○:Available, ✕:Not available)		
			Online*1		Offline*2
			SAFETY MODE	TEST MODE	
SB0008 (5E0H,b8)	Line test request	Executes line tests for the stations specified by SW0008. When executing a line test from GX Developer, do not write this by sequence programs or in a device test. OFF : Not requested ON : Requested	✕	○	✕
SB0020 (5E2H,b0)	Module status	Indicates the module access (module operation) status. Since this is information updated by the system, do not write this by sequence programs or in a device test. OFF : Normal (Module operating normally) ON : Error (Module error has occurred)	○	○	○

*1 Safety remote net (Ver. 1 mode)

*2 Off line, Hardware test or Line test.

Table8.5 Link Special Relay List (2/3)

Number	Name	Description	Availability (○:Available, ✕:Not available)		
			Online*1		Offline*2
			SAFETY MODE	TEST MODE	
SB004C (5E4 _H ,b12)	Line test acceptance status	Indicates the line test request (SB0008) acceptance status. OFF : Not accepted ON : Instruction acknowledged	✕	○	✕
SB004D (5E4 _H ,b13)	Line test complete status	Indicates the line test completion status. OFF : Not executed ON : Test complete	✕	○	✕
SB0050 (5E5 _H ,b0)	Offline test status	Indicates the offline test execution status. There are the following offline tests: line tests 1 and 2 and hardware test. OFF : Not executed ON : Being executed	✕	✕	○
SB0060 (5E6 _H ,b0)	Host mode	Indicates the setup status of the transmission rate/mode setting on the host. OFF : Online ON : Other than online	○	○	○
SB0061 (5E6 _H ,b1)	Host type	Indicates the station type of the host. OFF (Fixed) : Master station	○	○	✕
SB006A (5E6 _H ,b10)	Switch setting status	Indicates the switch setting status. OFF : Normal ON : Setting error (Error code stored in SW006A)	○	○	○
SB006D (5E6 _H ,b13)	Parameter setting status	Indicates the parameter setting status. OFF : Normal ON : Setting error (Error code stored in SW0068)	○	○	✕
SB006E (5E6 _H ,b14)	Host station operation status	Indicates the host data link operation status. OFF : Being executed ON : Not executed	○	○	✕

*1 Safety remote net (Ver. 1 mode)

*2 Off line, Hardware test or Line test.

1	OVERVIEW
2	SYSTEM CONFIGURATION
3	SPECIFICATIONS
4	FUNCTIONS
5	DATA LINK PROCESSING TIME AND STATION STATUS AT ERROR OCCURRENCE
6	PARAMETER SETTINGS
7	PROCEDURE BEFORE STARTING THE DATA LINK
8	PROGRAMMING SPECIFICATIONS

Table8.5 Link Special Relay List (3/3)

Number	Name	Description	Availability (○: Available, ✕:Not available)		
			Online* ¹		Offline* ²
			SAFETY MODE	TEST MODE	
SB0074 (5E7 _H ,b4)	Reserved station specified status	Indicates the information on the reserved stations specified by parameters. OFF : No specification ON : Specification exists (Information stored in SW0074 to SW0077)	○	○	✕
SB007C (5E7 _H ,b12)	Slave station refresh/forced clear setting status for PLC CPU STOP	Indicates the specification of whether to refresh or forcibly clear slave station data in the case of PLC CPU STOP. OFF : Refresh ON : Clears compulsorily	○	○	✕
SB0080 (5E8 _H ,b0)	Other station data link status* ³	Indicates the status of communication with safety remote I/O stations, standard remote I/O stations and remote device stations. Reserved stations are excluded. OFF : All stations normal ON : Faulty station exists (Information stored in SW0080 to SW0083)	○	○	✕
SB0081 (5E8 _H ,b1)	Other station watchdog timer error status	Indicates occurrence of a watchdog timer error in other stations. Reserved stations are excluded. OFF : No error ON : Error occurred	○	○	✕
SB0082 (5E8 _H ,b2)	Other station fuse blown status	Indicates a fuse blown status at other stations. (Information stored in SW0088 to SW008B) Reserved stations are excluded. OFF : No error ON : Error occurred	○	○	✕
SB0083 (5E8 _H ,b3)	Other station switch change status	Detects changes in setting switches of other stations during data linking. Reserved stations are excluded. OFF : No change ON : Change detected	○	○	✕

*1 Safety remote net (Ver. 1 mode)

*2 Off line, Hardware test or Line test.

*3 It takes up to 6 seconds from when a slave station error is identified in the safety master station until the Other station data link status (SB0080) turns ON.

The Time spent to turn it ON varies depending on the system configuration and faulty status.

8.3.2 Link special registers (SW)

Data in SW0000 to SW001F are changed with a sequence program or the device test function of GX Developer, and data are automatically stored in SB0020 to SB01FF. The values in parentheses in the number column indicate the buffer memory addresses.

Table 8.6 Link Special Register List (1/7)

Number	Name	Description	Availability (○:Available, ✕:Not available)		
			Online*1		Offline*2
			SAFETY MODE	TEST MODE	
SW0008 (608H)	Line test station setting	Sets the station for which line tests are executed. 0 : Entire system (executed for all stations) 01 to 64 : Specified station only Default value : 0	✕	○	✕
SW0020 (620H)	Module status	Indicates the status of communication with the safety CPU module. Since this is information updated by the system, do not write this by sequence programs or in a device test. 0 : Normal Other than 0 : Stores an error code for safety CPU module	○	○	○
SW004D (64DH)	Line test result	Indicates the execution result of the line test that was requested by SB0008. 0 : Normal Other than 0 : Stores an error code (see Section 9.5)	✕	○	✕
SW0058 (658H)	Detailed LED status	Stores the details of the LED indication status. 0 : OFF 1 : ON 	○	○	○

*1 Safety remote net (Ver. 1 mode)
*2 Off line, Hardware test or Line test.

1 OVERVIEW
2 SYSTEM CONFIGURATION
3 SPECIFICATIONS
4 FUNCTIONS
5 DATA LINK PROCESSING TIME AND STATION STATUS AT ERROR OCCURRENCE
6 PARAMETER SETTINGS
7 PROCEDURE BEFORE STARTING THE DATA LINK
8 PROGRAMMING SPECIFICATIONS

Table8.6 Link Special Register List (2/7)

Number	Name	Description	Availability (○:Available, :✕Not available)		
			Online*1		Offline*2
			SAFETY MODE	TEST MODE	
SW0059 (659H)	Transmission rate setting	<p>Stores the transmission rate setting.</p> <p>0 : Cancel 1 : Set</p>	○	○	○
SW0060 (660H)	Mode setting status	<p>Stores the mode setting status.</p> <p>0 : Online (Safety remote net (Ver.1 mode)) 2 : Offline 3 : Line test 1 4 : Line test 2 6 : Hardware test</p>	○	○	○
SW0062 (662H)	Module operating status	<p>Stores the operation setting status of the module.</p>	○	○	○

*1 Safety remote net (Ver. 1 mode)

*2 Off line, Hardware test or Line test.

Table 8.6 Link Special Register List (3/7)

Number	Name	Description	Availability (○:Available, ✕:Not available)																						
			Online*1		Offline*2																				
			SAFETY MODE	TEST MODE																					
SW0064 (664H)	No. of retries information	Indicates the retry count setting information when there is an error response. 1 to 7 (times)	○	○	✕																				
SW0065 (665H)	No. of automatic return stations	Indicates the setting information for the number of automatic return stations during one link scan. 1 to 10 (stations)	○	○	✕																				
SW0066 (666H)	Delay timer information	Fixed to 0 (μs)	○	○	✕																				
SW0067 (667H)	Parameter information	Stores the parameter information area to be used. 0H : CPU built-in parameters (Fixed)	○	○	✕																				
SW0068 (668H)	Host parameter status	Stores the parameter setting status. 0 : Normal 1 to : Stores an error code (see Section 9.5)	○	○	○																				
SW0069 (669H)	Installation status *3	Stores the overlap station number status and parameter consistency of each station. 0 : Normal 1 to : Stores an error code (see Section 9.5) Details are stored in SW0098 to 9B and SW009C to 9F.	○	○	✕																				
SW006A (66AH)	Switch setting status	Stores the switch setting status. 0 : Normal 1 to : Stores an error code (see Section 9.5)	○	○	○																				
SW006D (66DH)	Max. link scan time	Stores the maximum value of the link scan time. (in 1ms units)	○	○	✕																				
SW006E (66EH)	Current link scan time	Stores the current value of the link scan time. (in 1ms units)	○	○	✕																				
SW006F (66FH)	Min. link scan time	Stores the minimum value of the link scan time. (in 1ms units)	○	○	✕																				
SW0070 (670H)	Total number of stations	Stores the last station number set in the parameter. 1 to 64 (stations)	○	○	✕																				
SW0071 (671H)	Max. connected station number	Stores the highest station number (setting of the station number setting switch) among stations that are performing data link. 1 to 64 (stations)	○	○	✕																				
SW0072 (672H)	Number of connected modules	Stores the number of modules that are performing data link.	○	○	✕																				
SW0074 (674H)	Reserved station specification status *6	Stores the reserved station setting status. 0 : Other than reserved station 1 : Reserved station	○	○	✕																				
SW0075 (675H)		<table border="1"> <tr> <td></td> <td>b15</td> <td>b14</td> <td>b13</td> <td>b12</td> <td>to</td> <td>b3</td> <td>b2</td> <td>b1</td> <td>b0</td> </tr> <tr> <td>SW0074</td> <td>16</td> <td>15</td> <td>14</td> <td>13</td> <td>to</td> <td>4</td> <td>3</td> <td>2</td> <td>1</td> </tr> </table>					b15	b14	b13	b12	to	b3	b2	b1	b0	SW0074	16	15	14	13	to	4	3	2	1
		b15				b14	b13	b12	to	b3	b2	b1	b0												
SW0074		16				15	14	13	to	4	3	2	1												
SW0076 (676H)		<table border="1"> <tr> <td>SW0075</td> <td>32</td> <td>31</td> <td>30</td> <td>29</td> <td>to</td> <td>20</td> <td>19</td> <td>18</td> <td>17</td> </tr> <tr> <td>SW0076</td> <td>48</td> <td>47</td> <td>46</td> <td>45</td> <td>to</td> <td>36</td> <td>35</td> <td>34</td> <td>33</td> </tr> </table>				SW0075	32	31	30	29	to	20	19	18	17	SW0076	48	47	46	45	to	36	35	34	33
SW0075	32	31	30	29	to	20	19	18	17																
SW0076	48	47	46	45	to	36	35	34	33																
SW0077 (677H)	<table border="1"> <tr> <td>SW0077</td> <td>64</td> <td>63</td> <td>62</td> <td>61</td> <td>to</td> <td>52</td> <td>51</td> <td>50</td> <td>49</td> </tr> </table>	SW0077	64	63	62	61	to	52	51	50	49														
SW0077	64	63	62	61	to	52	51	50	49																
Numbers 1 to 64 in the above table indicate the station numbers.																									

*1 Safety remote net (Ver. 1 mode)
 *2 Off line, Hardware test or Line test.
 *3 This register checks and stores the status only at link startup.
 *6 Only the bit for the head station number is turned on.

1 OVERVIEW
 2 SYSTEM CONFIGURATION
 3 SPECIFICATIONS
 4 FUNCTIONS
 5 DATA LINK PROCESSING TIME AND STATION STATUS AT ERROR OCCURRENCE
 6 PARAMETER SETTINGS
 7 PROCEDURE BEFORE STARTING THE DATA LINK
 8 PROGRAMMING SPECIFICATIONS

Table8.6 Link Special Register List (4/7)

Number	Name	Description	Availability (○:Available, ✕:Not available)																																																				
			Online* ¹		Offline* ²																																																		
			SAFETY MODE	TEST MODE																																																			
SW0080 (680H)	Other station data link status* ⁴ * ⁵	Stores the data link status of each station. Reserved stations are excluded. 0 : Normal 1 : Data link error occurred <table border="1"> <thead> <tr> <th></th> <th>b15</th> <th>b14</th> <th>b13</th> <th>b12</th> <th>to</th> <th>b3</th> <th>b2</th> <th>b1</th> <th>b0</th> </tr> </thead> <tbody> <tr> <td>SW0080</td> <td>16</td> <td>15</td> <td>14</td> <td>13</td> <td>to</td> <td>4</td> <td>3</td> <td>2</td> <td>1</td> </tr> <tr> <td>SW0081</td> <td>32</td> <td>31</td> <td>30</td> <td>29</td> <td>to</td> <td>20</td> <td>19</td> <td>18</td> <td>17</td> </tr> <tr> <td>SW0082</td> <td>48</td> <td>47</td> <td>46</td> <td>45</td> <td>to</td> <td>36</td> <td>35</td> <td>34</td> <td>33</td> </tr> <tr> <td>SW0083</td> <td>64</td> <td>63</td> <td>62</td> <td>61</td> <td>to</td> <td>52</td> <td>51</td> <td>50</td> <td>49</td> </tr> </tbody> </table> Numbers 1 to 64 in the above table indicate the station numbers.		b15	b14	b13	b12	to	b3	b2	b1	b0	SW0080	16	15	14	13	to	4	3	2	1	SW0081	32	31	30	29	to	20	19	18	17	SW0082	48	47	46	45	to	36	35	34	33	SW0083	64	63	62	61	to	52	51	50	49	○	○	✕
			b15	b14	b13	b12	to	b3	b2	b1	b0																																												
SW0080			16	15	14	13	to	4	3	2	1																																												
SW0081			32	31	30	29	to	20	19	18	17																																												
SW0082	48	47	46	45	to	36	35	34	33																																														
SW0083	64	63	62	61	to	52	51	50	49																																														
SW0081 (681H)	Other station watchdog timer error occurrence status* ⁴	Indicates the watchdog timer error status. Reserved stations are excluded. 0 : No watchdog timer error 1 : Watchdog timer error occurred <table border="1"> <thead> <tr> <th></th> <th>b15</th> <th>b14</th> <th>b13</th> <th>b12</th> <th>to</th> <th>b3</th> <th>b2</th> <th>b1</th> <th>b0</th> </tr> </thead> <tbody> <tr> <td>SW0084</td> <td>16</td> <td>15</td> <td>14</td> <td>13</td> <td>to</td> <td>4</td> <td>3</td> <td>2</td> <td>1</td> </tr> <tr> <td>SW0085</td> <td>32</td> <td>31</td> <td>30</td> <td>29</td> <td>to</td> <td>20</td> <td>19</td> <td>18</td> <td>17</td> </tr> <tr> <td>SW0086</td> <td>48</td> <td>47</td> <td>46</td> <td>45</td> <td>to</td> <td>36</td> <td>35</td> <td>34</td> <td>33</td> </tr> <tr> <td>SW0087</td> <td>64</td> <td>63</td> <td>62</td> <td>61</td> <td>to</td> <td>52</td> <td>51</td> <td>50</td> <td>49</td> </tr> </tbody> </table> Numbers 1 to 64 in the above table indicate the station numbers.		b15	b14	b13	b12	to	b3	b2	b1	b0	SW0084	16	15	14	13	to	4	3	2	1	SW0085	32	31	30	29	to	20	19	18	17	SW0086	48	47	46	45	to	36	35	34	33	SW0087	64	63	62	61	to	52	51	50	49	○	○	✕
			b15	b14	b13	b12	to	b3	b2	b1	b0																																												
SW0084			16	15	14	13	to	4	3	2	1																																												
SW0085			32	31	30	29	to	20	19	18	17																																												
SW0086	48	47	46	45	to	36	35	34	33																																														
SW0087	64	63	62	61	to	52	51	50	49																																														
SW0082 (682H)	Other station fuse blown status* ⁴	Stores the fuse blown status of each station. Reserved stations are excluded. 0 : Normal 1 : Abnormal <table border="1"> <thead> <tr> <th></th> <th>b15</th> <th>b14</th> <th>b13</th> <th>b12</th> <th>to</th> <th>b3</th> <th>b2</th> <th>b1</th> <th>b0</th> </tr> </thead> <tbody> <tr> <td>SW0088</td> <td>16</td> <td>15</td> <td>14</td> <td>13</td> <td>to</td> <td>4</td> <td>3</td> <td>2</td> <td>1</td> </tr> <tr> <td>SW0089</td> <td>32</td> <td>31</td> <td>30</td> <td>29</td> <td>to</td> <td>20</td> <td>19</td> <td>18</td> <td>17</td> </tr> <tr> <td>SW008A</td> <td>48</td> <td>47</td> <td>46</td> <td>45</td> <td>to</td> <td>36</td> <td>35</td> <td>34</td> <td>33</td> </tr> <tr> <td>SW008B</td> <td>64</td> <td>63</td> <td>62</td> <td>61</td> <td>to</td> <td>52</td> <td>51</td> <td>50</td> <td>49</td> </tr> </tbody> </table> Numbers 1 to 64 in the above table indicate the station numbers.		b15	b14	b13	b12	to	b3	b2	b1	b0	SW0088	16	15	14	13	to	4	3	2	1	SW0089	32	31	30	29	to	20	19	18	17	SW008A	48	47	46	45	to	36	35	34	33	SW008B	64	63	62	61	to	52	51	50	49	○	○	✕
			b15	b14	b13	b12	to	b3	b2	b1	b0																																												
SW0088			16	15	14	13	to	4	3	2	1																																												
SW0089			32	31	30	29	to	20	19	18	17																																												
SW008A	48	47	46	45	to	36	35	34	33																																														
SW008B	64	63	62	61	to	52	51	50	49																																														
SW0083 (683H)																																																							
SW0084 (684H)																																																							
SW0085 (685H)																																																							
SW0086 (686H)																																																							
SW0087 (687H)																																																							
SW0088 (688H)																																																							
SW0089 (689H)																																																							
SW008A (68AH)																																																							
SW008B (68BH)																																																							

*1 Safety remote net (Ver. 1 mode)

*2 Off line, Hardware test or Line test.

*4 Bits for the number of occupied stations are turned on.

*5 It takes up to 6 seconds from when a slave station error is identified in the safety master station until the Other station data link status (SW0080 to SW0083) turns on.

The time spent to turn it ON varies depending on the system configuration and the faulty status.

Table 8.6 Link Special Register List (5/7)

Number	Name	Description	Availability (○:Available, ✕:Not available)																																																				
			Online*1		Offline*2																																																		
			SAFETY MODE	TEST MODE																																																			
SW008C (68C _H)	Other station switch change status *4	Indicates the switch change status of other stations that are performing data link. 0 : No change 1 : Changed <table border="1"> <thead> <tr> <th></th> <th>b15</th> <th>b14</th> <th>b13</th> <th>b12</th> <th>to</th> <th>b3</th> <th>b2</th> <th>b1</th> <th>b0</th> </tr> </thead> <tbody> <tr> <td>SW008C</td> <td>16</td> <td>15</td> <td>14</td> <td>13</td> <td>to</td> <td>4</td> <td>3</td> <td>2</td> <td>1</td> </tr> <tr> <td>SW008D</td> <td>32</td> <td>31</td> <td>30</td> <td>29</td> <td>to</td> <td>20</td> <td>19</td> <td>18</td> <td>17</td> </tr> <tr> <td>SW008E</td> <td>48</td> <td>47</td> <td>46</td> <td>45</td> <td>to</td> <td>36</td> <td>35</td> <td>34</td> <td>33</td> </tr> <tr> <td>SW008F</td> <td>64</td> <td>63</td> <td>62</td> <td>61</td> <td>to</td> <td>52</td> <td>51</td> <td>50</td> <td>49</td> </tr> </tbody> </table> Numbers 1 to 64 in the above table indicate the station numbers.		b15	b14	b13	b12	to	b3	b2	b1	b0	SW008C	16	15	14	13	to	4	3	2	1	SW008D	32	31	30	29	to	20	19	18	17	SW008E	48	47	46	45	to	36	35	34	33	SW008F	64	63	62	61	to	52	51	50	49	○	○	✕
			b15	b14	b13	b12	to	b3	b2	b1	b0																																												
SW008C			16	15	14	13	to	4	3	2	1																																												
SW008D			32	31	30	29	to	20	19	18	17																																												
SW008E	48	47	46	45	to	36	35	34	33																																														
SW008F	64	63	62	61	to	52	51	50	49																																														
SW008D (68D _H)	Station number overlap status *6, *7	Stores the overlap status when the head station number of each module is not overlapped. Reserved stations are overlapped. 0 : Normal 1 : Station number overlapped (Head station number only) <table border="1"> <thead> <tr> <th></th> <th>b15</th> <th>b14</th> <th>b13</th> <th>b12</th> <th>to</th> <th>b3</th> <th>b2</th> <th>b1</th> <th>b0</th> </tr> </thead> <tbody> <tr> <td>SW0098</td> <td>16</td> <td>15</td> <td>14</td> <td>13</td> <td>to</td> <td>4</td> <td>3</td> <td>2</td> <td>1</td> </tr> <tr> <td>SW0099</td> <td>32</td> <td>31</td> <td>30</td> <td>29</td> <td>to</td> <td>20</td> <td>19</td> <td>18</td> <td>17</td> </tr> <tr> <td>SW009A</td> <td>48</td> <td>47</td> <td>46</td> <td>45</td> <td>to</td> <td>36</td> <td>35</td> <td>34</td> <td>33</td> </tr> <tr> <td>SW009B</td> <td>64</td> <td>63</td> <td>62</td> <td>61</td> <td>to</td> <td>52</td> <td>51</td> <td>50</td> <td>49</td> </tr> </tbody> </table> Numbers 1 to 64 in the above table indicate the station numbers.		b15	b14	b13	b12	to	b3	b2	b1	b0	SW0098	16	15	14	13	to	4	3	2	1	SW0099	32	31	30	29	to	20	19	18	17	SW009A	48	47	46	45	to	36	35	34	33	SW009B	64	63	62	61	to	52	51	50	49	○	○	✕
			b15	b14	b13	b12	to	b3	b2	b1	b0																																												
SW0098			16	15	14	13	to	4	3	2	1																																												
SW0099			32	31	30	29	to	20	19	18	17																																												
SW009A	48	47	46	45	to	36	35	34	33																																														
SW009B	64	63	62	61	to	52	51	50	49																																														
SW008E (68E _H)																																																							
SW008F (68F _H)																																																							
SW0098 (698 _H)																																																							
SW0099 (699 _H)																																																							
SW009A (69A _H)																																																							
SW009B (69B _H)																																																							

*1 Safety remote net (Ver. 1 mode)

*2 Off line, Hardware test or Line test.

*4 Only the bits for the number of occupied stations are turned on.

*6 Only the bit for the first station number is turned on.

*7 This is checked and stored only when the data link is started or when parameters are updated.

1	OVERVIEW
2	SYSTEM CONFIGURATION
3	SPECIFICATIONS
4	FUNCTIONS
5	DATA LINK PROCESSING TIME AND STATION STATUS AT ERROR OCCURRENCE
6	PARAMETER SETTINGS
7	PROCEDURE BEFORE STARTING THE DATA LINK
8	PROGRAMMING SPECIFICATIONS

Table8.6 Link Special Register List (6/7)

Number	Name	Description	Availability (○:Available, ✕:Not available)																																																								
			Online* ¹		Offline* ²																																																						
			SAFETY MODE	TEST MODE																																																							
SW009C (69C _H)	Installation status * ³ , * ⁶	<p>Stores the consistency status between the actual installation and the parameter settings. Reserved stations are excluded. A matching error occurs in either of the following cases.</p> <p>1) Station type mismatch* 2) Mismatch in number of occupied stations</p> <p>* An error is detected only when the actually loaded module is a remote device station with the parameters set as a safety or standard remote I/O station. (A matching error does not occur when the actually loaded module is a safety or standard remote I/O station with the parameters set as a remote device station. Also no matching error occurs when the actually loaded module is a safety remote I/O station with the parameters set as a standard remote I/O station, and vice versa.)</p> <p>0 : Normal 1 : Matching error</p> <p>Example of matching error</p> <table border="1" style="margin-left: auto; margin-right: auto;"> <thead> <tr> <th>Installation</th> <th>Parameter</th> </tr> </thead> <tbody> <tr> <td>Remote device station</td> <td>Remote I/O station</td> </tr> </tbody> </table> <table border="1" style="margin-left: auto; margin-right: auto;"> <thead> <tr> <th></th> <th>b15</th> <th>b14</th> <th>b13</th> <th>b12</th> <th>to</th> <th>b3</th> <th>b2</th> <th>b1</th> <th>b0</th> </tr> </thead> <tbody> <tr> <td>SW009C</td> <td>16</td> <td>15</td> <td>14</td> <td>13</td> <td>to</td> <td>4</td> <td>3</td> <td>2</td> <td>1</td> </tr> <tr> <td>SW009D</td> <td>32</td> <td>31</td> <td>30</td> <td>29</td> <td>to</td> <td>20</td> <td>19</td> <td>18</td> <td>17</td> </tr> <tr> <td>SW009E</td> <td>48</td> <td>47</td> <td>46</td> <td>45</td> <td>to</td> <td>36</td> <td>35</td> <td>34</td> <td>33</td> </tr> <tr> <td>SW009F</td> <td>64</td> <td>63</td> <td>62</td> <td>61</td> <td>to</td> <td>52</td> <td>51</td> <td>50</td> <td>49</td> </tr> </tbody> </table> <p>Numbers 1 to 64 in the above table indicate the station numbers.</p>	Installation	Parameter	Remote device station	Remote I/O station		b15	b14	b13	b12	to	b3	b2	b1	b0	SW009C	16	15	14	13	to	4	3	2	1	SW009D	32	31	30	29	to	20	19	18	17	SW009E	48	47	46	45	to	36	35	34	33	SW009F	64	63	62	61	to	52	51	50	49	○	○	✕
Installation			Parameter																																																								
Remote device station			Remote I/O station																																																								
			b15	b14	b13	b12	to	b3	b2	b1	b0																																																
SW009C	16	15	14	13	to	4	3	2	1																																																		
SW009D	32	31	30	29	to	20	19	18	17																																																		
SW009E	48	47	46	45	to	36	35	34	33																																																		
SW009F	64	63	62	61	to	52	51	50	49																																																		
SW009D (69D _H)																																																											
SW009E (69E _H)																																																											
SW009F (69F _H)																																																											
SW00B4 (6B4 _H)	Line test 1 result * ⁴	<p>Stores the line test 1 result.</p> <p>0 : Normal 1 : Abnormal</p> <table border="1" style="margin-left: auto; margin-right: auto;"> <thead> <tr> <th></th> <th>b15</th> <th>b14</th> <th>b13</th> <th>b12</th> <th>to</th> <th>b3</th> <th>b2</th> <th>b1</th> <th>b0</th> </tr> </thead> <tbody> <tr> <td>SW00B4</td> <td>16</td> <td>15</td> <td>14</td> <td>13</td> <td>to</td> <td>4</td> <td>3</td> <td>2</td> <td>1</td> </tr> <tr> <td>SW00B5</td> <td>32</td> <td>31</td> <td>30</td> <td>29</td> <td>to</td> <td>20</td> <td>19</td> <td>18</td> <td>17</td> </tr> <tr> <td>SW00B6</td> <td>48</td> <td>47</td> <td>46</td> <td>45</td> <td>to</td> <td>36</td> <td>35</td> <td>34</td> <td>33</td> </tr> <tr> <td>SW00B7</td> <td>64</td> <td>63</td> <td>62</td> <td>61</td> <td>to</td> <td>52</td> <td>51</td> <td>50</td> <td>49</td> </tr> </tbody> </table> <p>Numbers 1 to 64 in the above table indicate the station numbers.</p>		b15	b14	b13	b12	to	b3	b2	b1	b0	SW00B4	16	15	14	13	to	4	3	2	1	SW00B5	32	31	30	29	to	20	19	18	17	SW00B6	48	47	46	45	to	36	35	34	33	SW00B7	64	63	62	61	to	52	51	50	49	✕	○	○				
			b15	b14	b13	b12	to	b3	b2	b1	b0																																																
SW00B4			16	15	14	13	to	4	3	2	1																																																
SW00B5			32	31	30	29	to	20	19	18	17																																																
SW00B6	48	47	46	45	to	36	35	34	33																																																		
SW00B7	64	63	62	61	to	52	51	50	49																																																		
SW00B5 (6B5 _H)																																																											
SW00B6 (6B6 _H)																																																											
SW00B7 (6B7 _H)																																																											
SW00B8 (6B8 _H)	Line test result	<p>Stores the result of line tests 1/2.</p> <p>0 :Normal 1 :Stores an error code (see Section 9.5)</p>	✕	✕	○																																																						

*1 Safety remote net (Ver. 1 mode)
*2 Off line, Hardware test or Line test.
*3 This register checks and stores the status only at link startup.
*4 Bits for the number of occupied stations are turned on.
*6 Only the bit for the head station number is turned on.

Table 8.6 Link Special Register List (7/7)

Number	Name	Description	Availability (○:Available, ✕:Not available)																																																									
			Online*1		Offline*2																																																							
			SAFETY MODE	TEST MODE																																																								
SW0140 (740H)	Compatible CC-Link ver. information *6	Indicates the slave stations compatible with CC-Link ver. 2. 0 : Ver.1 compatible slave station 1 : Ver.2 compatible slave station <table border="1"> <thead> <tr> <th></th> <th>b15</th> <th>b14</th> <th>b13</th> <th>b12</th> <th>to</th> <th>b3</th> <th>b2</th> <th>b1</th> <th>b0</th> </tr> </thead> <tbody> <tr> <td>SW0140</td> <td>16</td> <td>15</td> <td>14</td> <td>13</td> <td>to</td> <td>4</td> <td>3</td> <td>2</td> <td>1</td> </tr> <tr> <td>SW0141</td> <td>32</td> <td>31</td> <td>30</td> <td>29</td> <td>to</td> <td>20</td> <td>19</td> <td>18</td> <td>17</td> </tr> <tr> <td>SW0142</td> <td>48</td> <td>47</td> <td>46</td> <td>45</td> <td>to</td> <td>36</td> <td>35</td> <td>34</td> <td>33</td> </tr> <tr> <td>SW0143</td> <td>64</td> <td>63</td> <td>62</td> <td>61</td> <td>to</td> <td>52</td> <td>51</td> <td>50</td> <td>49</td> </tr> </tbody> </table> Numbers 1 to 64 in the above table indicate the station numbers.		b15	b14	b13	b12	to	b3	b2	b1	b0	SW0140	16	15	14	13	to	4	3	2	1	SW0141	32	31	30	29	to	20	19	18	17	SW0142	48	47	46	45	to	36	35	34	33	SW0143	64	63	62	61	to	52	51	50	49	○	○	✕					
			b15	b14	b13	b12	to	b3	b2	b1	b0																																																	
SW0140			16	15	14	13	to	4	3	2	1																																																	
SW0141			32	31	30	29	to	20	19	18	17																																																	
SW0142			48	47	46	45	to	36	35	34	33																																																	
SW0143	64	63	62	61	to	52	51	50	49																																																			
SW0141 (741H)																																																												
SW0142 (742H)																																																												
SW0143 (743H)																																																												
SW0144 (744H)	Stores the CC-Link version matching status between the parameters and slave stations. Reserved stations are excluded. (Remote device stations that can be specified with parameters are Ver.1 compatible remote device stations, not Ver.2 compatible remote device stations.) 0 : Normal 1 : Matching error Example of matching error <table border="1"> <thead> <tr> <th>Installation</th> <th>Parameter</th> </tr> </thead> <tbody> <tr> <td>Ver.2compatible remote device station</td> <td>Ver.1compatible remote device station</td> </tr> <tr> <td>Ver.1compatible remote device station</td> <td>Ver.2compatible remote device station</td> </tr> </tbody> </table> <table border="1"> <thead> <tr> <th></th> <th>b15</th> <th>b14</th> <th>b13</th> <th>b12</th> <th>to</th> <th>b3</th> <th>b2</th> <th>b1</th> <th>b0</th> </tr> </thead> <tbody> <tr> <td>SW0144</td> <td>16</td> <td>15</td> <td>14</td> <td>13</td> <td>to</td> <td>4</td> <td>3</td> <td>2</td> <td>1</td> </tr> <tr> <td>SW0145</td> <td>32</td> <td>31</td> <td>30</td> <td>29</td> <td>to</td> <td>20</td> <td>19</td> <td>18</td> <td>17</td> </tr> <tr> <td>SW0146</td> <td>48</td> <td>47</td> <td>46</td> <td>45</td> <td>to</td> <td>36</td> <td>35</td> <td>34</td> <td>33</td> </tr> <tr> <td>SW0147</td> <td>64</td> <td>63</td> <td>62</td> <td>61</td> <td>to</td> <td>52</td> <td>51</td> <td>50</td> <td>49</td> </tr> </tbody> </table> Numbers 1 to 64 in the above table indicate the station numbers.	Installation	Parameter	Ver.2compatible remote device station	Ver.1compatible remote device station	Ver.1compatible remote device station	Ver.2compatible remote device station		b15	b14	b13	b12	to	b3	b2	b1	b0	SW0144	16	15	14	13	to	4	3	2	1	SW0145	32	31	30	29	to	20	19	18	17	SW0146	48	47	46	45	to	36	35	34	33	SW0147	64	63	62	61	to	52	51	50	49	○	○	✕
Installation		Parameter																																																										
Ver.2compatible remote device station		Ver.1compatible remote device station																																																										
Ver.1compatible remote device station		Ver.2compatible remote device station																																																										
		b15	b14	b13	b12	to	b3	b2	b1	b0																																																		
SW0144	16	15	14	13	to	4	3	2	1																																																			
SW0145	32	31	30	29	to	20	19	18	17																																																			
SW0146	48	47	46	45	to	36	35	34	33																																																			
SW0147	64	63	62	61	to	52	51	50	49																																																			
SW0145 (745H)																																																												
SW0146 (746H)																																																												
SW0147 (747H)																																																												
SW0148 (748H)	Parameter mode	Indicates in which mode the system is operating. 0 : Remote net ver.1 mode (Fixed)	○	○	✕																																																							
SW0149 (749H)	Host parameter mode	Indicates in which mode the host is operating. 0 : Remote net ver.1 mode (Fixed)	○	○	○																																																							

*1 Safety remote net (Ver. 1 mode)
 *2 Off line, Hardware test or Line test.
 *4 Bits for the number of occupied stations are turned on.
 *6 Only the bit for the head station number is turned on.

1 OVERVIEW
 2 SYSTEM CONFIGURATION
 3 SPECIFICATIONS
 4 FUNCTIONS
 5 DATA LINK PROCESSING TIME AND STATION STATUS AT ERROR OCCURRENCE
 6 PARAMETER SETTINGS
 7 PROCEDURE BEFORE STARTING THE DATA LINK
 8 PROGRAMMING SPECIFICATIONS

The timing when the data in a link special register (SW) is updated differs depending on the link register number.

Table8.7 lists the update timings of link special registers.

Table8.7 Update timing of the link special registers

Link special register	Data update timing	Link special register	Data update timing
SW0060	When SB0060 changes	SW0074 to SW0077	When SB0074 changes
SW0067	Updated independently regardless of SB	SW0080 to SW0083	When SB0080 changes
SW0068		SW0088 to SW008B	Updated independently regardless of SB
SW0069		SW0098 to SW009B	
SW006D		SW009C to SW009F	
SW006E		SW00B4 to SW00B7	
SW006F		SW00B8	
SW0070			
SW0071		Updated independently regardless of SB(Update after each station is stable.)	---
SW0072			

CHAPTER9 TROUBLESHOOTING

This chapter describes the details of the problems that may occur in the CC-Link Safety System, and lists the check items and procedures for each of the possible problems.

9.1 Checking the Condition by Each Problem

The following lists the details of the check items and procedures for each problem occurrence.

Description of problem	Check item	Check procedure	Check result	Corrective action
Unable to perform data link for the entire system.	Is there any breakage on CC-Link dedicated cables?	Check the CC-Link dedicated cables (for breakage, short-circuit, incorrect wiring, poor contact or nonconformance) visually or by the CC-Link diagnostics line test.	A cable fault is found.	Remove the cause of the fault and correct the connection.
			No cable fault is found.	Check other items.
	Are terminating resistors connected to the stations located at both ends of the CC-Link Safety system?	Visually check the connection of the terminating resistors.	Terminating resistors are not connected to the terminal stations, or they are connected to any other stations.	Connect the terminating resistors supplied with the safety master module to the terminal stations in the CC-Link Safety system.
			Terminating resistors are connected to the terminal stations.	Check other items.
	Are correct terminating resistors used?	Visually check the terminating resistors.	Terminating resistors other than the ones supplied with the safety master module are connected.	Connect the terminating resistors supplied with the safety master module to the terminal stations in the CC-Link Safety system.
			Terminating resistors that are supplied with the safety master module are connected.	Check other items.
	Are CC-Link dedicated cables being used? Are different types of CC-Link dedicated cables used together?	Check the specifications of the cables.	They are not CC-Link dedicated cables.	Use CC-Link dedicated cables.
			Different types of CC-Link dedicated cables are used together.	Use only one type of CC-Link dedicated cables.
			Only one type of CC-Link dedicated cables is used.	Check other items.
	Has any error occurred in the safety CPU module?	Check the "ERR" LED of the safety CPU module.	"ERR." LED is ON or flashing.	Perform troubleshooting for the safety CPU module.
			"ERR." LED is OFF.	Check other items.
	Has any error occurred on the safety power supply module?	Check the "POWER" LED on the safety power supply module.	"POWER." LED is OFF.	Turn OFF the power and then ON. If the error persists, replace the safety power supply module.
			"POWER." LED is ON.	Check other items.

Description of problem	Check item	Check procedure	Check result	Corrective action
Unable to perform data link for the entire system	Doesn't the sequence scan time exceed the allowable value for each transmission speed? 156kbps: 800ms 625kbps: 400ms 2.5Mbps: 100ms 5Mbps : 50ms 10Mbps : 50ms	Check special register SD526 (Maximum scan time).	The maximum scan time exceeds the allowable value.	Modify the sequence program to shorten the scan time, or reduce the transmission speed.
			The maximum scan time is the allowable value or less.	Check other items.
	Is the mode set for the safety master module "Safety remote network-Ver.1 mode"?	Check the mode setting in network parameters.	The set mode is not "Safety remote network-Ver.1 mode".	Change the mode setting for the safety master module to "Safety remote network-Ver.1 mode".
			The mode is set to "Safety remote network-Ver.1 mode".	Check other items.
	Aren't there more than one safety master module on the same CC-Link network?	Check if the safety master modules on the same base are connected via CC-Link or not.	Connected	Correct the connection.
			Not connected	Check other items.
		Reset the safety CPU module, or turn the power OFF and then ON, and then check if the "ERR." LED on the safety master module flashes.	"ERR." LED on the safety master module is ON or flashing.	Take measures referring to Section 9.2 and 9.3 Check with LEDs.
			"ERR." LED on the safety master module is OFF.	Check other items. If all the check results are normal, a hardware fault of the safety master module may be probable. Contact your local Mitsubishi representative.
	Has any error occurred on the safety master module?	Select the safety master module on the system monitor, and check the error code.	An error code is displayed.	Take measures referring to Section 9.5.
			"No Error" is displayed.	Check other items.
		Check if the "ERR." LED on the safety master module is ON or flashing.	"ERR" LED on the safety master module is ON or flashing.	Take measures referring to Section 9.2 and 9.3 Check with LEDs.
			"ERR" LED on the safety master module is OFF.	Check other items.

Description of problem	Check item	Check procedure	Check result	Corrective action
Unable to receive inputs from a remote station/ Unable to output data from a remote station	Is the auto refresh setting correctly made?	Check the auto refresh setting.	The auto refresh setting is incorrectly made.	Modify the auto refresh setting.
			The auto refresh setting is correctly made.	Check other items.
	Is the remote station recognized by the safety master module?	Check the status of the remote station by the other station monitor of the CC-Link diagnostics.	The remote station is not recognized.	Modify the network parameter setting.
			The remote station is recognized.	Check other items.
	Is the remote station set as a reserved station?	Check the status of the remote station by the other station monitor of the CC-Link diagnostics.	The remote station is set as a reserved station.	Cancel the reserved station setting of the remote station by changing the station information in network parameters.
			The remote station is not set as a reserved station.	Check other items.
	Is the station No. of the remote station overlapped?	Check the station No. of the remote station.	The station No. is overlapped.	Modify the station No. setting.
			The station No. is not overlapped.	Check other items.
	Is there any connected station that does not meet the network parameter setting?	Conduct a line test of the CC-Link diagnostics with all stations specified, and check if there is a faulty station.	A faulty station is found.	Modify the network parameter setting or the remote station setting.
			No faulty station is found.	Check other items.
		When safety remote station is set in Network parameters setting, activate the other station monitor and check for a link error.	Link error	Correct the network parameter setting and write it to the safety CPU module, or replace the remote station with a safety remote module.
			Link error (***) (***) shows error details.)	Troubleshoot the safety CPU module.
			Communicating normally	Check other items.
		When standard remote station is set in Network parameters setting, check if a safety remote station is connected as the relevant station number.	A safety remote station is connected.	Correct the network parameter setting and write it to the safety CPU module, or replace the remote station with a standard remote module.
	No difference between the network parameter setting and actual installation.		Check other items.	

Description of problem	Check item	Check procedure	Check result	Corrective action
Unable to receive inputs from a remote station/ Unable to output data from a remote station	Are the safety master modules on the same base connected with a CC-Link dedicated cable?	Check if the safety master modules on the same base are connected via CC-Link or not.	Connected	Secure a normal connection state.
			Not connected	Check other item.
		Reset the safety CPU on the safety master station, or turn the power OFF and then ON and check if the "ERR" LED on the safety master module flashes.	"ERR" LED on the safety master module is ON or flashing.	Take measures referring to Section 9.2 and 9.3 Check with LEDs.
			"ERR" LED on the safety master module is OFF.	Check other items. If all the check results are normal, a hardware fault of the safety master module may be probable. Contact your local Mitsubishi representative.
	Has an error occurred on the remote station?	Check if the "ERR" LED on the remote station is flashing or not.	"ERR" LED on the remote station is ON or flashing.	Perform troubleshooting for the remote station.
			"ERR." LED on the remote station is OFF.	Check other items. If all the check results are normal, a hardware fault of the safety master module or the remote module. Contact your local Mitsubishi representative.

Description of problem	Check item	Check procedure	Check result	Corrective action
A communication error occurs during communication with a remote station.	Has any operation including ROM writing been done to the CPU module?	From GX Developer, check if the following has been done. (1) Switching the operation mode (2) Writing the program memory to the ROM area (3) Saving or changing the CPU access password (4) Initializing the PLC memory	Any of the operations shown in the left has been performed.	Reset the safety CPU or turn OFF the power and then ON.
			None of the operations shown in the left has been performed.	Check other items.
	Has the power supply momentarily stopped?	Check the error history of the PLC diagnostics and special register SD53 (AD/DC DOWN detection count).	AC/DC DOWN (Error code: 1500) has been registered in the error history, and the count of special register SD53 has been increased.	Change the mode to Asynchronous, or reduce the transmission rate.
			AC/DC DOWN (Error code: 1500) has not been registered in the error history, or the count of special register SD53 has not been increased.	Check other items.
	Is an error information on communication with the remote station registered in the error history? (Safety remote I/O stations only)	In the error history of the PLC diagnostics, check the following information: • No. • Link ID • Station No.	A CC-Link Safety error (The first two digits of the error code is 83) has been registered in the error history.	Take measures referring to the error code of the safety CPU module.
			A CC-Link Safety error (The first two digits of the error code is 83) has not been registered in the error history.	Check other items.
	Has any error occurred on the safety master module?	Select the safety master module on the system monitor, and check the error code.	An error code is displayed.	Take measures referring to the error code list in Section 9.5.
			"No Error" is displayed.	Check other items.
		Check if the "ERR." LED on the safety master module is ON or flashing.	"ERR." LED on the safety master module is ON or flashing. "ERR." LED on the safety master module is OFF.	Take measures referring to Section 9.2 and 9.3 Check with LEDs. Check other items.
	Is the station No. setting of the remote station correct?	Check if the station No. of the remote station is matched with the station information setting in network parameters.	Not matched	Correct the station information in network parameters or the station No. setting of the remote station to make them matched.
			Matched	Check other items.

Description of problem	Check item	Check procedure	Check result	Corrective action
A communication error occurs during communication with a remote station.	Is the transmission speed setting of the remote station correct?	Check if the transmission speed set in network parameters is matched with the one set on the remote station.	Not matched	Correct the transmission speed set in network parameters or the one set on the remote station to make them matched.
			Matched	Check other items.
	Is the link ID setting of the remote station correct? (Safety remote I/O stations only)	Check if the link ID set in network parameters is matched with the one set on the remote station.	Not matched	Correct the link ID set in network parameters or the one set on the remote station to make them matched.
			Matched	Check other items.
	Was a correct safety refresh monitoring time set for the scan time?	Check if any online operation has been performed from GX Developer. Check special register SD526 (Maximum scan time) and calculate "Safety refresh monitoring time". (See Section 5.2.1)Check the value set for the safety refresh monitoring time.	Performed	Increase the value set for the safety refresh monitoring time.
			Not performed	Check other items.
			The calculated "Safety refresh monitoring time" value is greater than the set value.	Examine the sequence program and reduce the scan time. Or, increase the set safety refresh monitoring timer value.
			The calculated "Safety refresh monitoring time" value is less than the set value or is appropriate.	In "Constant scan" on "PLC RAS setting" of PLC parameter, set a value greater than "Max. scan time".Or, check other items.
	Was a correct safety data monitoring time set?	Check the safety data monitoring time setting value.	The calculated "Safety data monitoring time" is shorter than the set value.	Increase the value set for the safety data monitoring timer.
		Check if the maximum scan time (SD526) is within the constant scan time.	The maximum scan time (SD526) exceeds the constant scan time.	Increase the constant scan setting value, and also correct the value for the safety refresh monitoring timer and the safety data monitoring timer.
	Isn't the station No. overlapped?	Check the station No. setting of the remote station.	The station No. is overlapped.	Correct the station No. setting.
			The station No. is not overlapped.	Check other items.

Description of problem	Check item	Check procedure	Check result	Corrective action
A communication error occurs during communication with a remote station.	Is there any breakage on CC-Link dedicated cables?	Check the CC-Link dedicated cables (for breakage, short-circuit, incorrect wiring, poor contact or nonconformance) visually or by the CC-Link diagnostics line test.	A cable fault is found.	Remove the cause of the fault and correct the connection.
			No cable fault is found.	Check other items.
	Are terminating resistors connected to the stations located at both ends of the CC-Link Safety system?	Visually check the connection of the terminating resistors.	Terminating resistors are not connected to the terminal stations, or they are connected to any other stations.	Connect terminating resistors suitable for the cable type to both ends of the CC-Link Safety network.
			Terminating resistors are connected to the terminal stations.	Check other items.
	Are CC-Link dedicated cables being used? Are different types of CC-Link dedicated cables used together?	Check the specifications of the cables.	They are not CC-Link dedicated cables.	Use CC-Link dedicated cables.
			Different types of CC-Link dedicated cables are used together.	Use only one type of CC-Link dedicated cables.
			Only one type of CC-Link dedicated cables is used.	Check other items.
	Has any error occurred on the remote station?	Check the status of the remote station by the other station monitor of the CC-Link diagnostics.	An error has occurred on the remote station.	Perform troubleshooting for the remote module.
			No error has occurred on the remote station.	Check other items. If all the check results are normal, a hardware fault of the safety master module or the remote module may be probable. Contact your local Mitsubishi representative.
	A remote station is not started.	Is power properly supplied to the remote station?	Check the power supply to the remote station.	Power is not supplied to the remote station, or power is supplied improperly.
Power is properly supplied to the remote station.				Check other items.
Is the number of connected remote stations larger than the All connect count value that is preset in network parameters?		Check the All connect count value preset in network parameters and the number of remote stations actually connected.	The number of remote stations actually connected is larger than the All connect count value preset in network parameters.	Correct the All connect count value in network parameters so that it is matched with the number of remote stations actually connected.
			The number of remote stations actually connected is not larger than the All connect count value preset in network parameters.	Check other items.

Description of problem	Check item	Check procedure	Check result	Corrective action
A remote station is not started.	Is the number of connected remote stations within the allowable range?	Check if it is within the allowable range or not referring to Section 2.1 Overall Configuration.	The number of connected remote stations is exceeding the limit.	Reduce the number of connected remote stations.
			The number of connected remote stations is within the allowable range.	Check other items.
	Is the terminal block or connector for T-branch system correctly connected? (If the module is used in the T-branch system.)	Visually check the connection of the terminal block or connector for T-branch system.	The terminal block or connector for T-branch system is incorrectly connected.	Correctly connect the terminal block or connector for T-branch system.
			The terminal block or connector for T-branch system is correctly connected.	Check other items.
	Is the terminating resistor connected to the correct location? (If a repeater is used.)	Check if the terminating resistor is connected to the correct location.	The terminating resistor is connected to an incorrect location.	Connect the terminating resistor to the correct location.
			The terminating resistor is connected to the correct location.	Check other items.
	Is there any breakage on CC-Link dedicated cables?	Check the CC-Link dedicated cables (for breakage, short-circuit, incorrect wiring, poor contact or nonconformance) visually or by the CC-Link diagnostics line test.	A cable fault is found.	Remove the cause of the fault and correct the connection.
			No cable fault is found.	Check other items. If all the check results are normal, a hardware fault of the safety master module or the remote module may be probable. Contact your local Mitsubishi representative.
Unable to detect a faulty station.	Isn't the station number overlapped?	Check the parameters.	The station No. is overlapped.	Correct the station No. setting.
			The station No. is not overlapped.	Check other items.
An error is generated on a station depending on the transmission speed.	If the transmission speed is reduced to a lower level such as 156 kbps, can communication be performed without an error?	Change the transmission speed to 156kbps in network parameters, and check the communication status by the other station monitor of the CC-Link diagnostics.	Communication is performed normally.	Modify the transmission speed setting.
			A communication error occurs.	Change the transmission speed in network parameters again, and check the result.
A remote device station is not operating normally.	Is there any fault in the program for the remote device station's initial setting?	Check the sequence program.	A fault is found in the sequence program.	Modify the sequence program.
			There is no fault in the sequence program.	Check other items.

Description of problem	Check item	Check procedure	Check result	Corrective action
When multiple remote stations are powered off at 156 kbps, the "L RUN" LED goes off temporarily.	Does the scan time exceed the permitted value corresponding to the transmission rate?	Check special register SD526 (Maximum scan time).	The permitted value is exceeded.	Increase the transmission rate, or reduce the number of retries.
			The permitted value is not exceeded.	Check other items.
A disconnected data link error station does not automatically return to the system even if it was restored to normal.	Has the module been replaced with the one having the different number of occupied stations and station type during data link?	Check if the settings in network parameters are matched with the number of occupied station and station type of the remote station.	Not matched	Replace it with a module that has the same number of occupied stations and station type as the settings. When changing the number of occupied stations or station type, reset the safety master station after the change.
			Matched	Check other items.
A disconnected data link error station does not automatically return to the system even if it was restored to normal.	Has the interlock of the safety remote station been deactivated?	If the station that is not auto-returned is a safety remote station, check whether special registers SD1072 to SD1075 (Safety station interlock status) have been turned ON. (For the second safety master module, check SD1272 to SD1275.)	The bit corresponding to the relevant station No. is ON.	Turn ON the bit corresponding to the relevant station in special registers SD1076 to SD1079 (Safety station interlock cancel request). (For the second safety master module, turn ON the corresponding bit in SD1276 to SD1279.)
			The bit corresponding to the relevant station No. is not ON.	Check other items.

9.2 Check with LEDs (1) - at System Start-up

This section explains troubleshooting using the LEDs at system start-up.

9.2.1 When "RUN" LED on the safety master module does not turn ON with "POWER" LED on the safety power supply module being ON

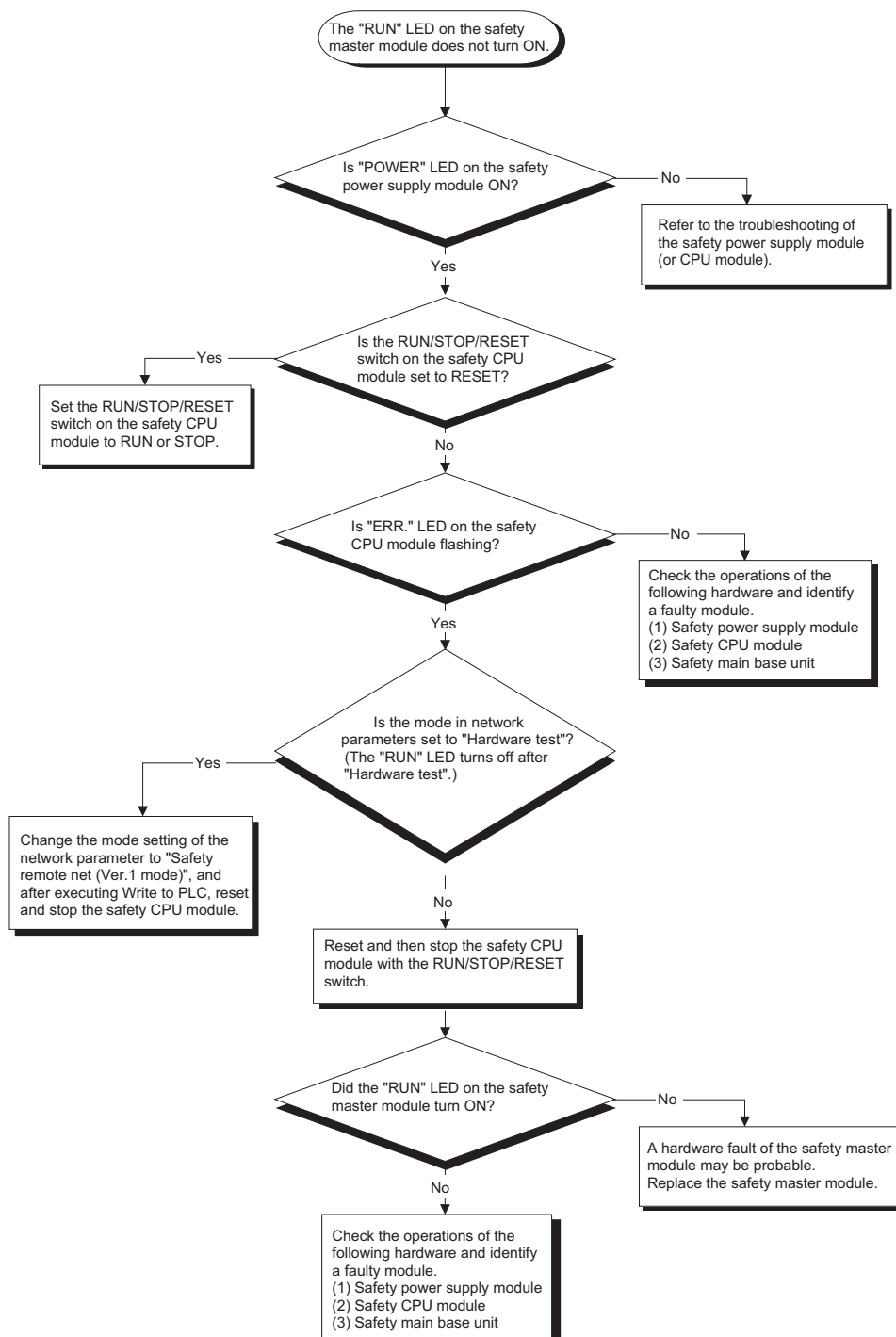

9.2.2 When "ERR." LED on the safety master module turns ON or flashes with "RUN" LED on the safety master module being ON

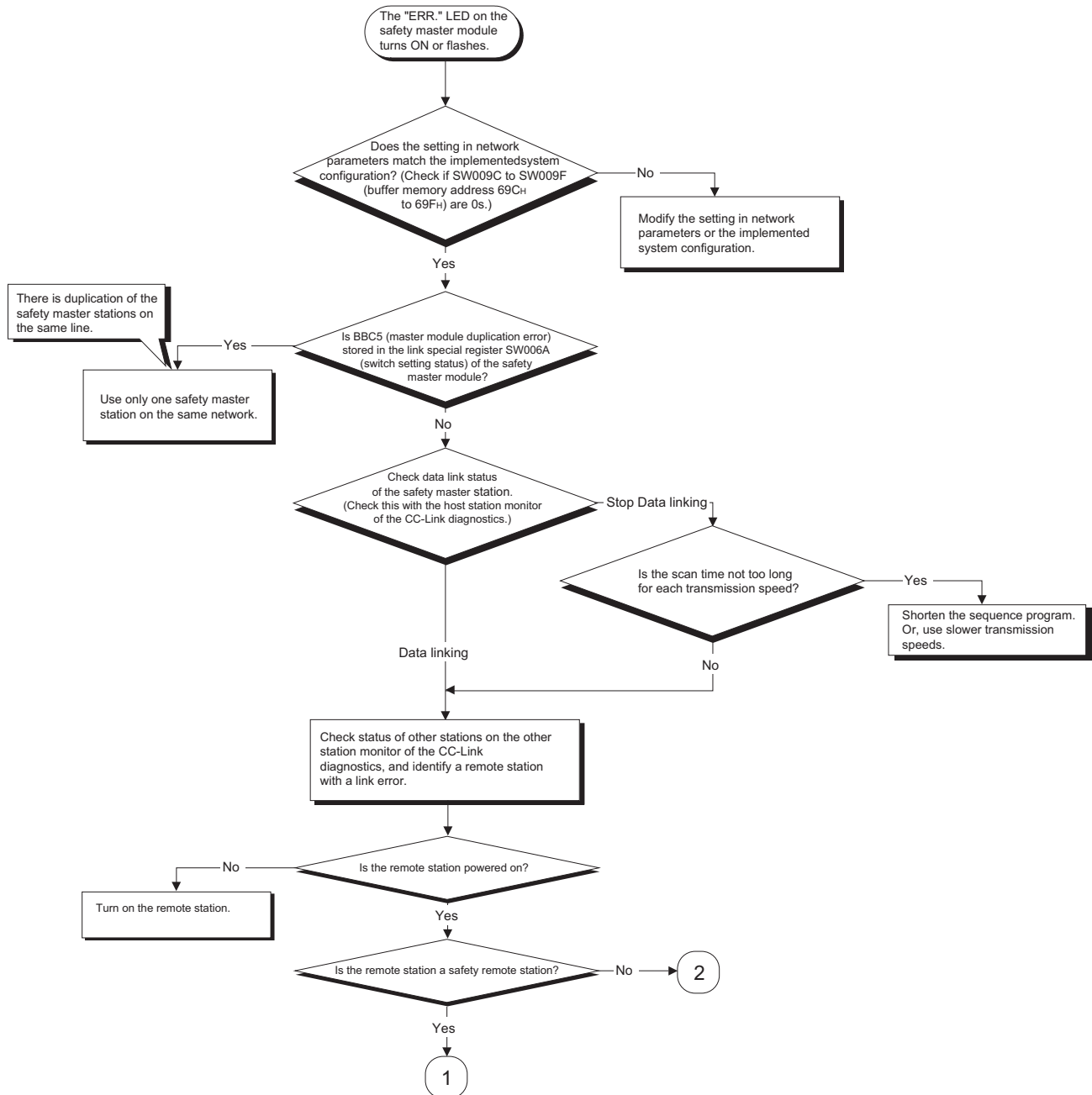

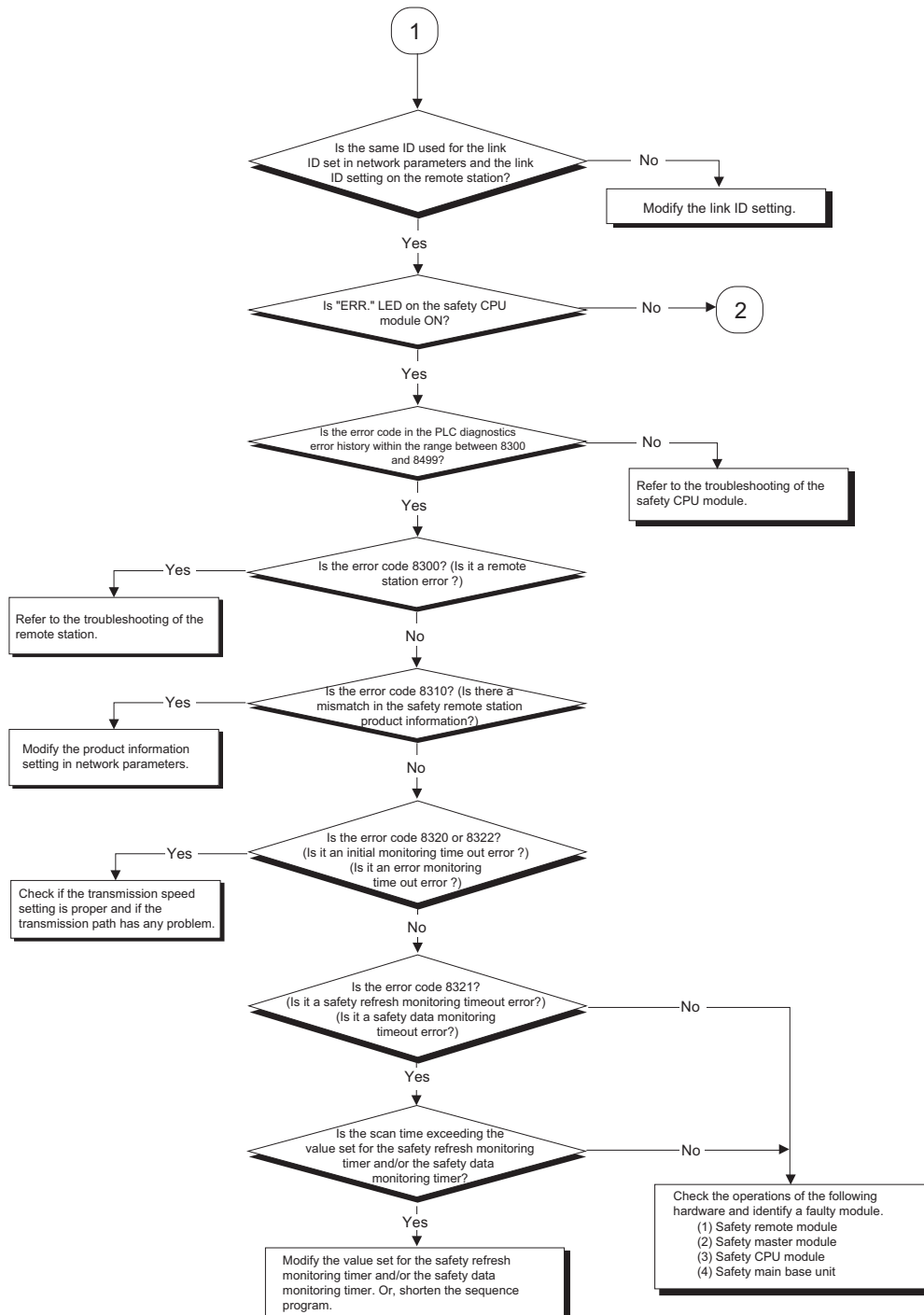

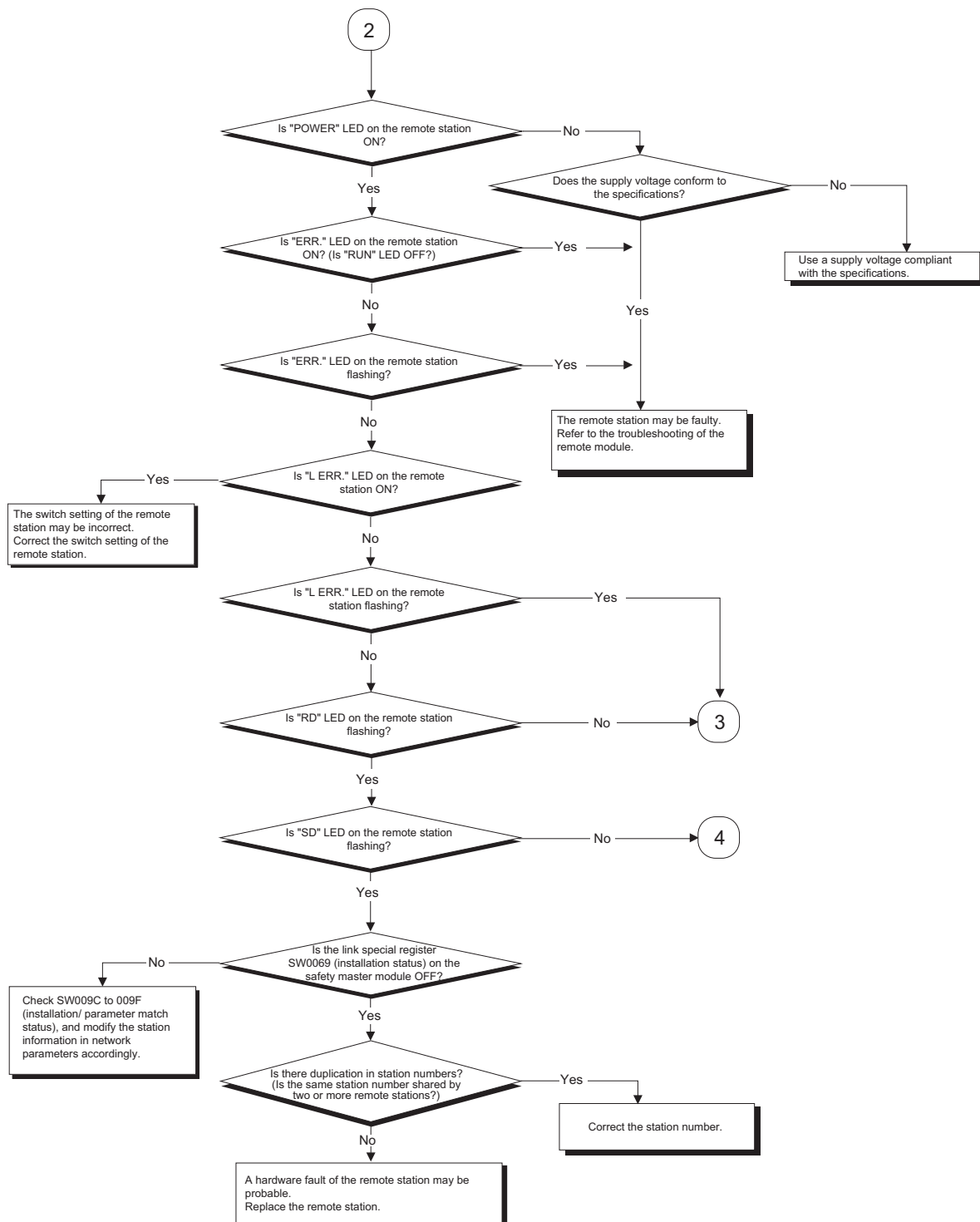

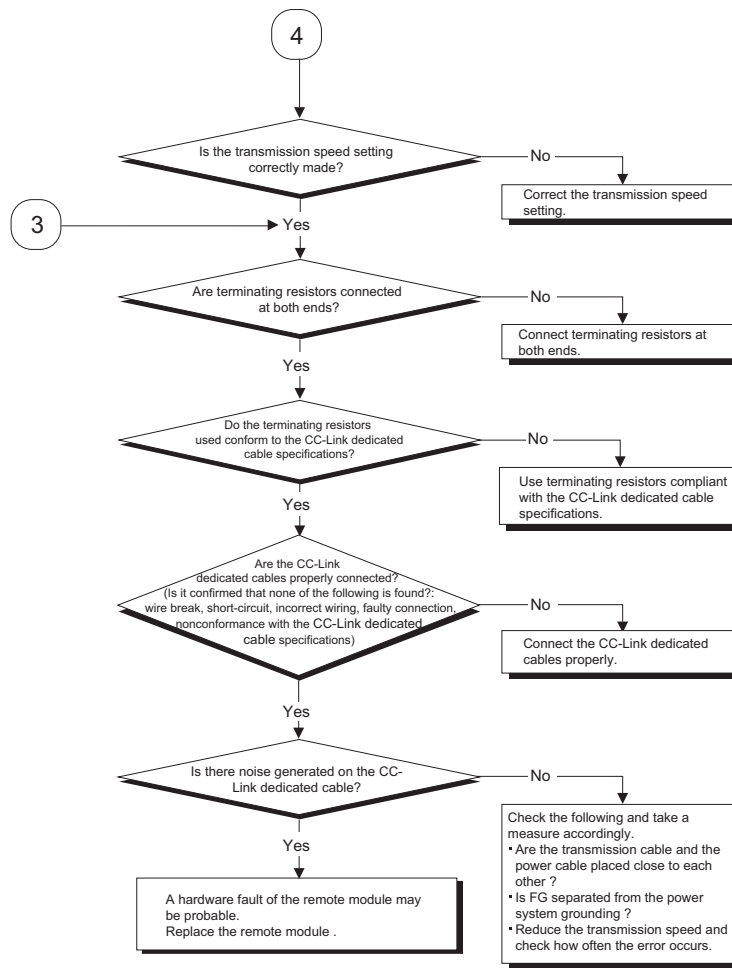

9.2.3 When receiving inputs or outputting data from a remote station is not possible despite "ERR." LED OFF status of the safety master module

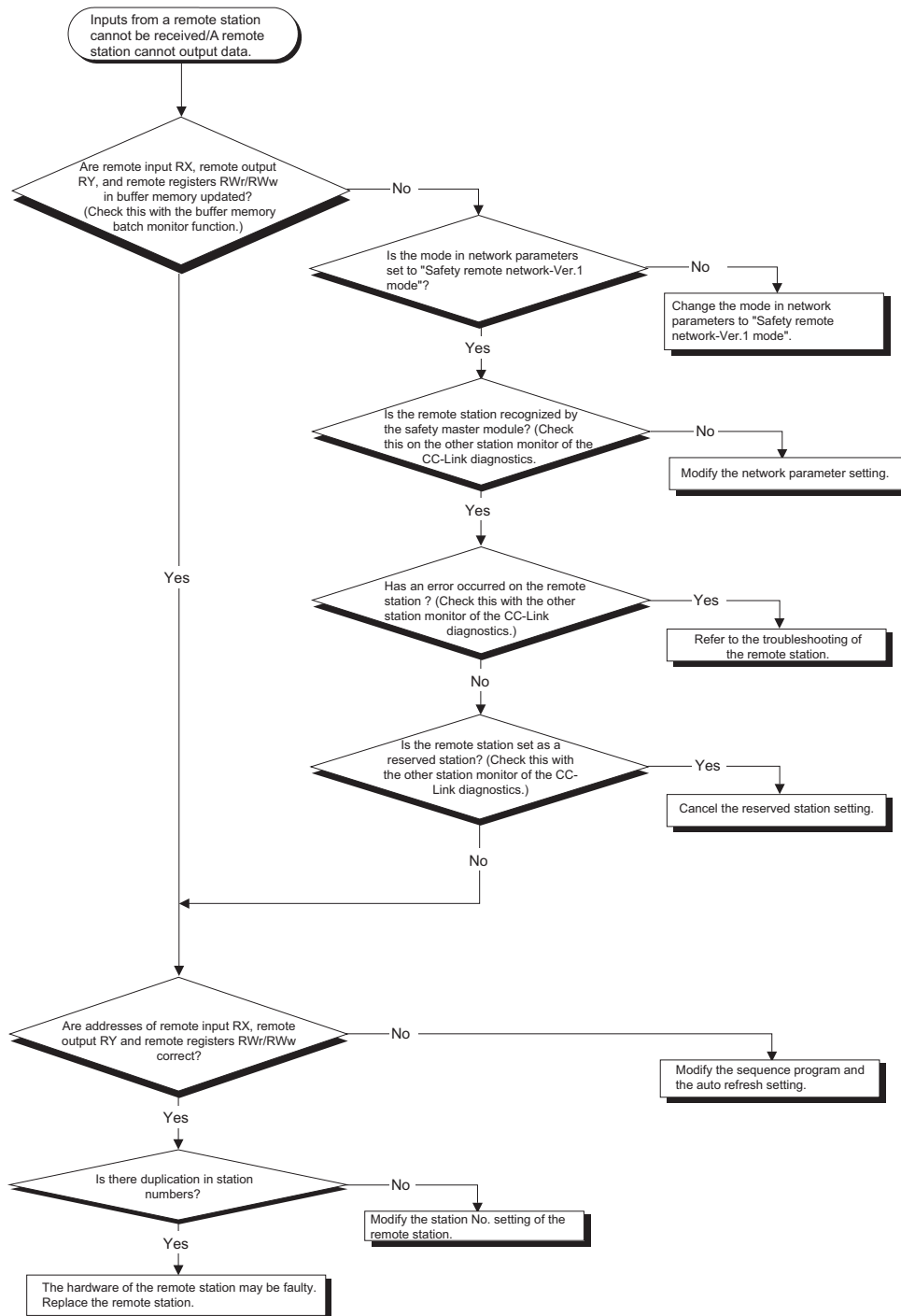

9.3 Check with LEDs (2) - During System Operation

This section explains troubleshooting using the LEDs while the system is in operation.

9.3.1 When "ERR." LED on the safety master module turns ON or flashes with "RUN" LED on the safety master module being ON



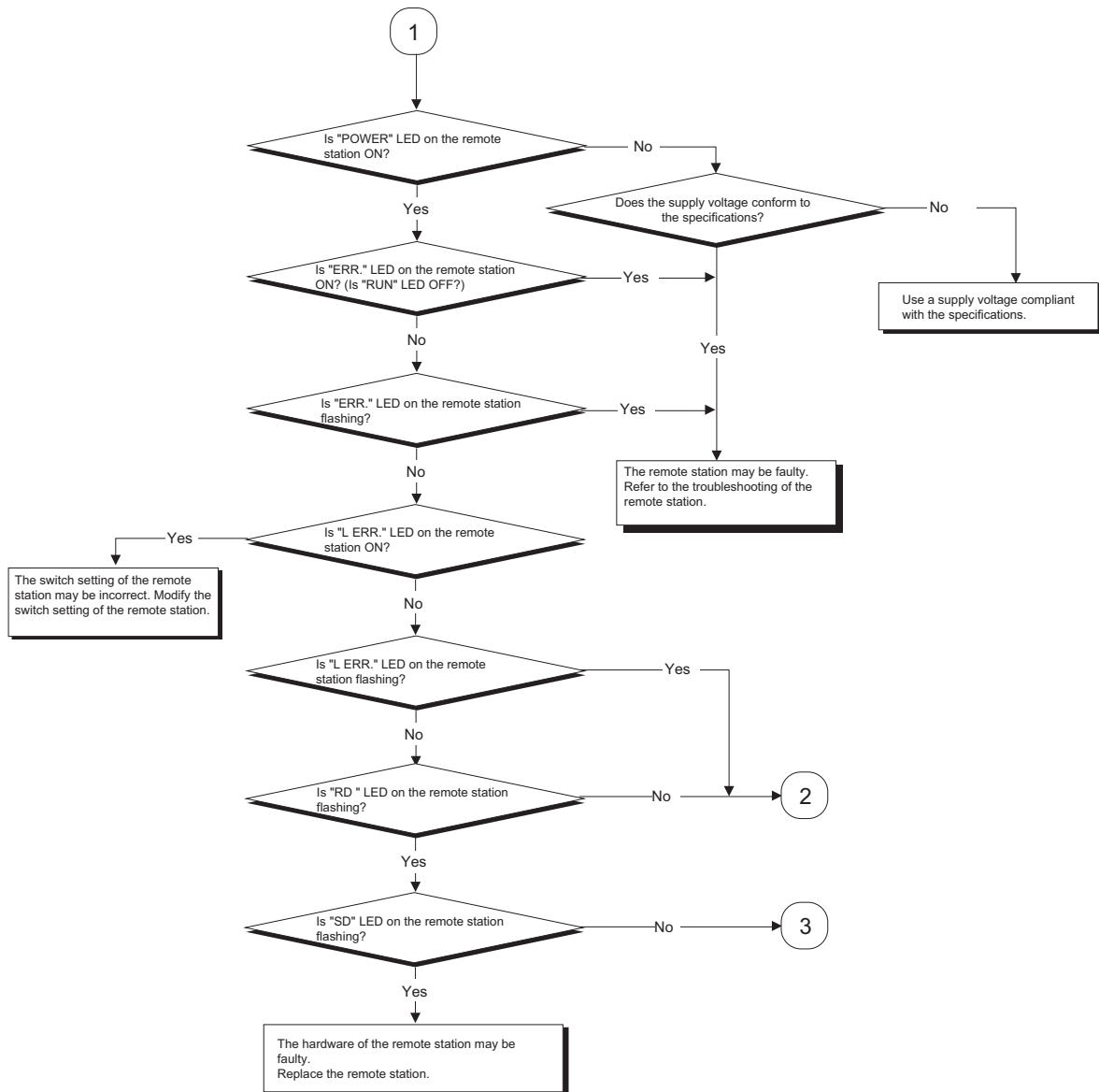

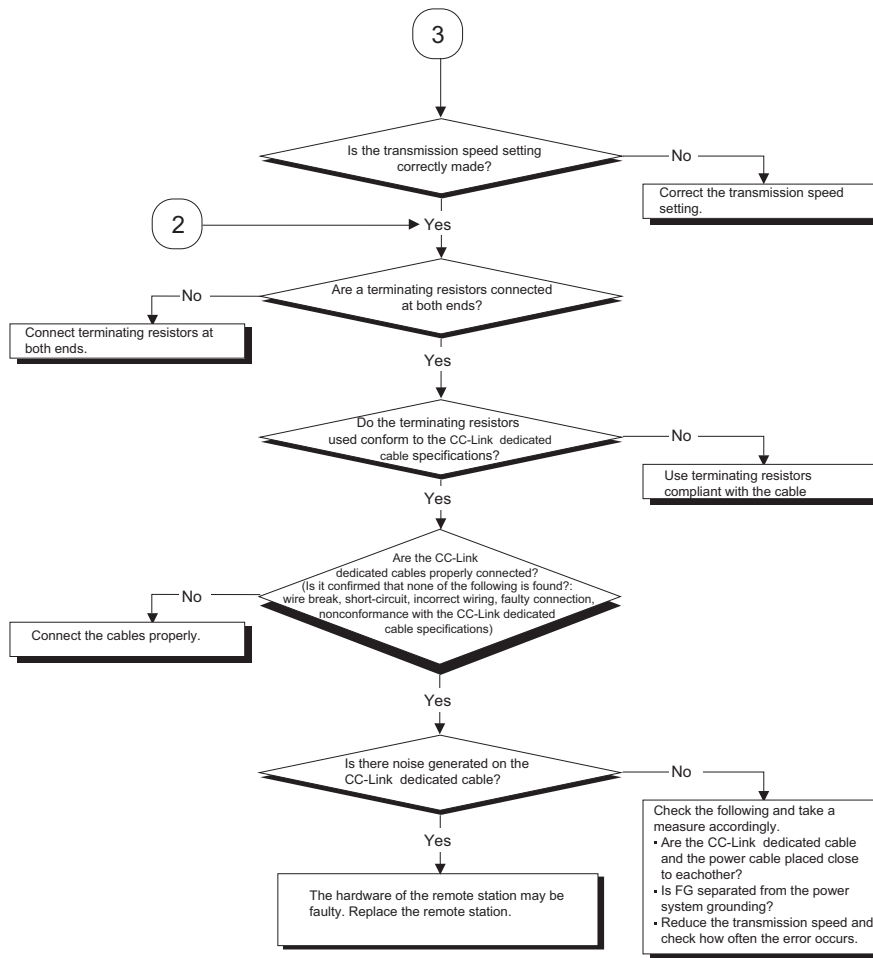

9.3.2 When receiving inputs or outputting data from a remote station is not possible with "ERR." LED on the safety master module being OFF

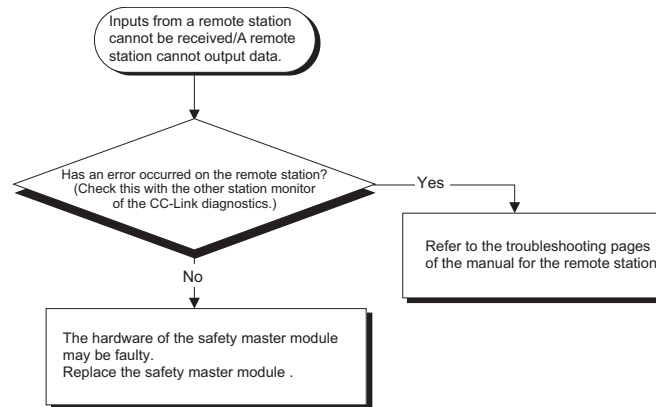

9.3.3 When "RUN" LED on the safety master module turns OFF suddenly

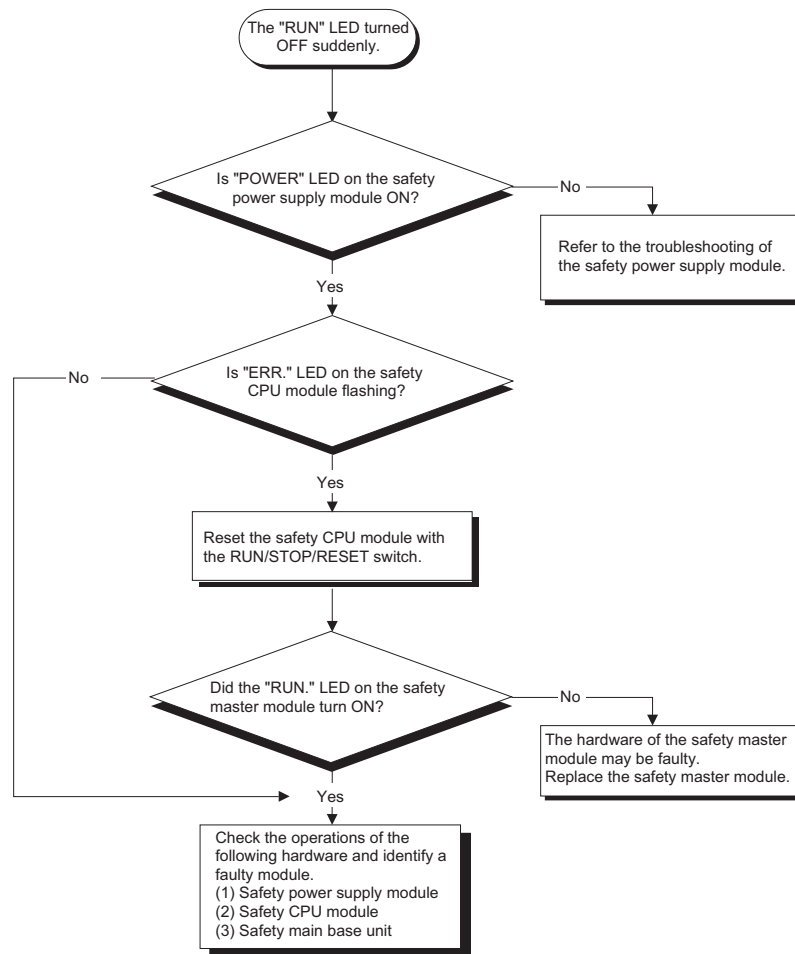

9.4 CC-Link Diagnostics Using GX Developer

Check the status of each module after connecting all the modules with CC-Link dedicated cables, and verify that data link can be performed normally.

(1) Host monitoring

Follow the procedure below to monitor various states including the data link status of the safety master station (the station to which GX Developer is connected).

(a) Operating procedure

[Diagnostics] → [CC-Link / CC-Link/LT Diagnostics]

1) Select "CC-Link Safety" for "Module Setting".

2) Specify the target module for Host monitoring with "Module No." or "I/O Address".

3) Click the Start Monitoring button.

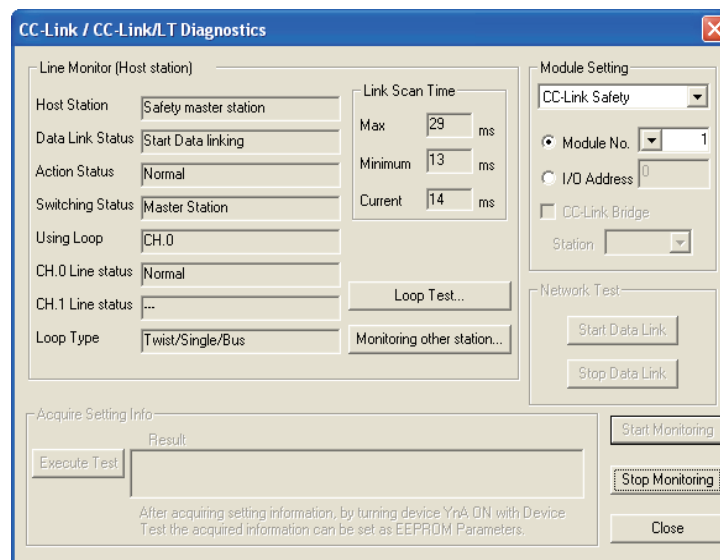

(b) Monitoring items

1) Host station

Displays the station type of the station being monitored (Safety master station).

2) Data link status

Displays the data link status of the host.

3) Action status

Displays the operating status of the host.

4) Switching status

Displays that the data link is controlled by the safety master station.

5) Using Line

Displays the line in use.

6) Line status

Displays the line status.

7) Line type

Displays the line type.

(2) Other station monitoring

Follow the procedure below to monitor the states such as the data link status of a remote station (stations other than the one to which GX Developer is connected).

(a) Operating procedure

[Diagnostics] → [CC-Link / CC-Link/LT Diagnostics]

- 1) Select "CC-Link Safety" for "Module Setting".
- 2) Specify the target master module for other station monitoring with "Module No." or "I/O Address".
- 3) Click the button.
- 4) Click the button.

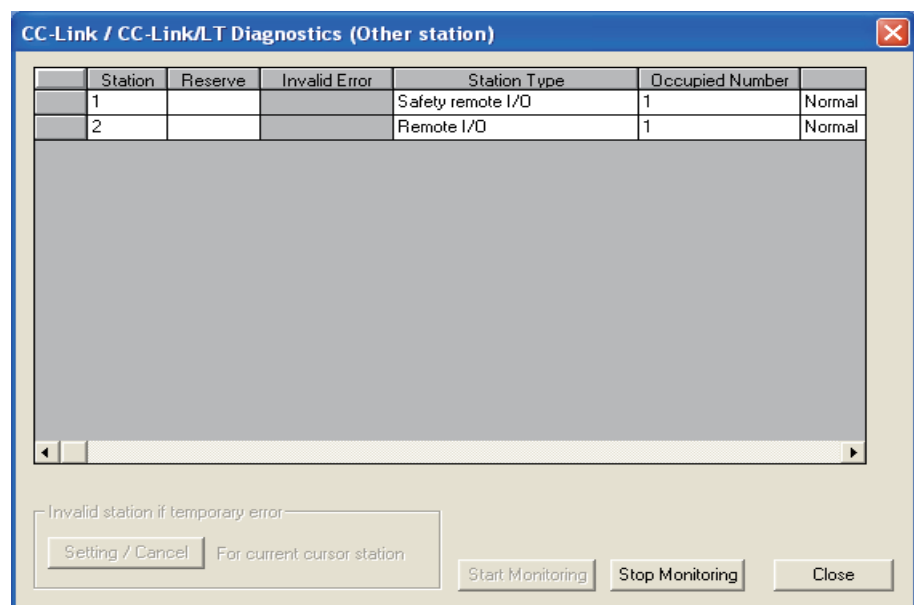

(b) Monitoring items

- 1) Station
Displays the head station number of each station.
- 2) Reserve
Displays whether or not a reserved station is set.
" * ": Reserved station is set.
" " ": Reserved station is not set.
- 3) Invalid error
Not used in CC-Link Safety systems.
- 4) Station type
Displays the station type.
- 5) Occupied number
Displays the number of occupied stations.
- 6) Status
Displays the link status of the module.
- 7) Transient error
Not used in CC-Link Safety systems.
- 8) Manufacturer name
Displays the manufacturer name of the remote station.

(3) Line test

This test checks the operating status of the connected remote stations. Normal stations are displayed "blue", abnormal stations "red", reserved stations "green", and unused stations "gray".

The line test is available only when the safety CPU module is in TEST MODE.

(a) Operating procedure

[Diagnostics] → [CC-Link / CC-Link/LT Diagnostics]

- 1) Select "CC-Link Safety" for "Module Setting".
- 2) Specify the target master module for the line test with "Module No." or "I/O Address".

3) Click the button.

4) Click the button.

5) When checking the communication status of all stations

Select "All stations" for "Target station", and click the button.

6) When checking the communication status of a specific module

Select "Selected station No." for "Target station", specify the station number, and click the button.

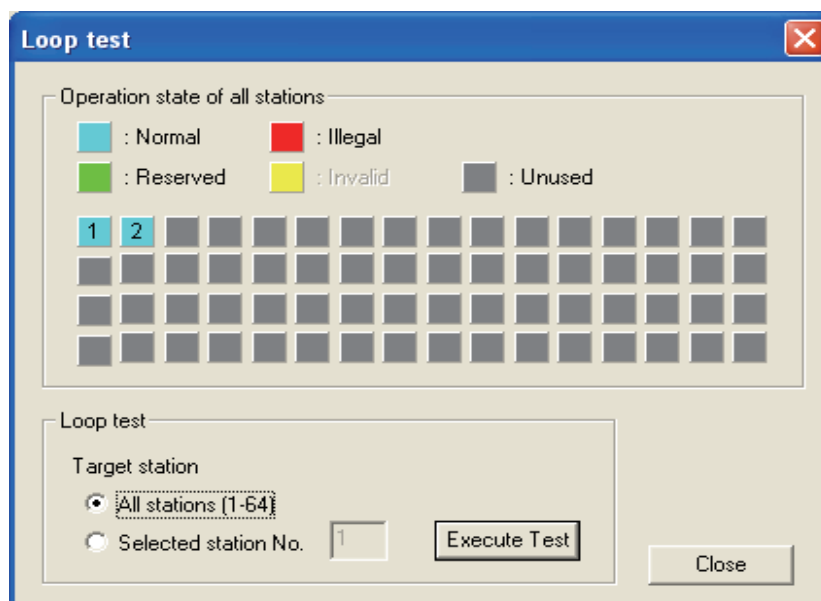

POINT

When conducting a line test, do not write any data to bit 8 (SB0008) of 5E0H and 608H (SW0008) in the buffer memory.

Also, if auto refresh devices are set for SB and SW in the network parameter setting, do not write any data to the relevant CPU devices.

(4) H/W Information

The H/W Information screen displays the operation and setting statuses of the safety master module.

(a) Operating procedure

[Diagnostics] → [System monitor]

1) Select the QS0J61BT12.

2) Click the Module Detailed Information button.

3) Click the H/W Information button.

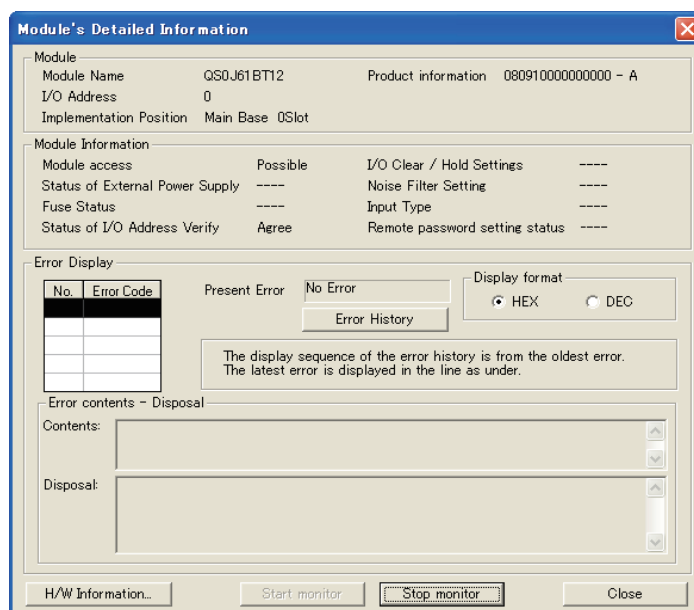

(b) Product information

The function version and serial No. are displayed as follows.

080910000000000-A

↑ Function Version A

↑ Serial No. (first 5 digits) (Example)

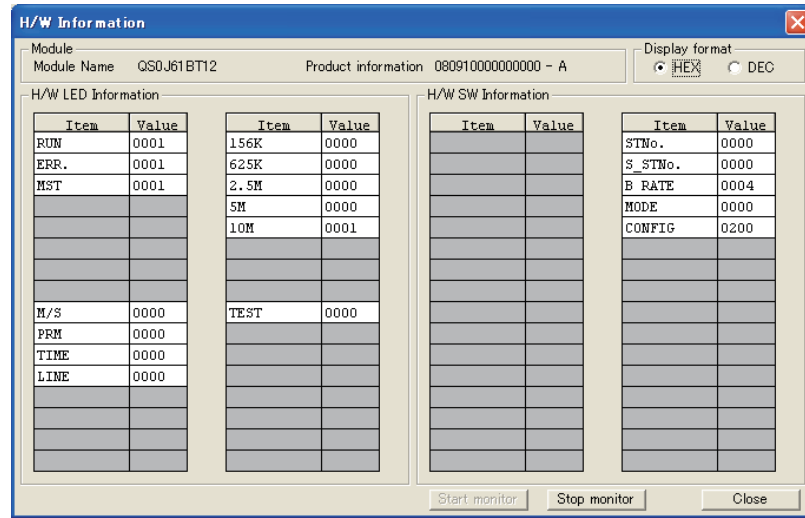

(c) H/W LED Information

The H/W LED Information area displays the following data link information. If network parameters are not set, "0" is displayed for each of transmission speeds "156K to 10M".

Item	Value
RUN	1: Module is operating normally. 0: Watchdog timer error
ERR.	1: All stations are faulty. Switching between 0 and 1: There is a faulty station.
MST	1: Set to the master station
M/S	1: A master station already exists on the same line.
PRM	1: There is an error in the parameter settings.
TIME	1: The data link monitoring timer was activated.
LINE	1: Cable is disconnected or the transmission path is affected by noise, etc.
156K	1: Transmission speed is set to 156 kbps.
625K	1: Transmission speed is set to 625 kbps.
2.5M	1: Transmission speed is set to 2.5 Mbps.
5M	1: Transmission speed is set to 5 Mbps.
10M	1: Transmission speed is set to 10 Mbps.
TEST	1: Hardware test is being executed

(d) H/W SW Information

The H/W SW Information area displays the following information.

Item	Value
STNo.	Station No. setting value
S_STNo.	Unused (Fixed to 0)
B RATE	Transmission speed setting status 00 _H : 156kbps 01 _H : 625kbps 02 _H : 2.5Mbps 03 _H : 5Mbps 04 _H : 10Mbps
MODE	Mode setting status 00 _H : Online 02 _H : Offline 03 _H : Line test 1 04 _H : Line test 2 06 _H : Hardware test
CONFIG	SW62 (Module operation status)

9.5 Error Codes

The table below lists the error codes that are stored in the link special registers (SW) and displayed on the CC-Link diagnostics screen.

Table 9.1 Error Code List (1/6)

Error code (hexadecimal)	Error details	Cause of error occurrence (details)	Corrective action
B000	System error	A system error was detected.	Perform the following procedures: (1) Check if the safety master module, safety power supply module, and safety CPU module are properly mounted on the safety base unit. (2) Check if the operation environment of the safety master module is within the general specifications for the safety CPU module. (3) Check if the power capacity is sufficient. (4) Check if the hardware of the safety master module, safety CPU module and safety base unit is normal, according to each manual. In the case of failure, please contact your local Mitsubishi service center or representative for repair. (5) If the problem is not resolved by the above, please consult your local Mitsubishi service center or representative, explaining a detailed description of the problem.
B100	System error	A system error was detected.	
B120	Forced termination of the remote device station initialize procedure registration	In the remote device station initialize procedure registration, the instruction device of the registration was turned off before completion of all procedures.	Turn off the instruction device of the remote device station initialize procedure registration after completion of all procedures.
B124	Target station error for the remote device station initialize procedure registration	The remote device station initialize procedure registration instruction device for a station other than the master station was turned on.	Turn on the remote device station initialization procedure registration instruction device for the master station (station No.0).
B125	Parameter for the remote device station initialize procedure registration has not been set.	The remote device station initialize procedure registration instruction device was turned on without setting the procedure registration.	Set the remote device station initialize procedure registration before turning on the instruction device of the registration.
B126	Remote device station initialize procedure registration setting change error	The initialize procedure execution setting was changed after the initialize procedure start was instructed.	Set the remote device station initialize procedure registration before turning on the instruction device of the registration.

Table 9.1 Error Code List (2/6)

Error code (hexadecimal)	Error details	Cause of error occurrence (details)	Corrective action								
B200	System error	A system error was detected.	Perform the following procedures: (1) Check if the safety master module, safety power supply module, and safety CPU module are properly mounted on the safety base unit. (2) Check if the operation environment of the safety master module is within the general specifications for the safety CPU module. (3) Check if the power capacity is sufficient. (4) Check if the hardware of the safety master module, safety CPU module and safety base unit is normal, according to each manual. In the case of failure, please contact your local Mitsubishi service center or representative for repair. (5) If the problem is not resolved by the above, please consult your local Mitsubishi service center or representative, explaining a detailed description of the problem.								
B300	System error	A system error was detected.									
B301	Processing request error during link stop	Line test request was issued while the link was stopped.	Perform a line test while the link is active.								
B304	Error station detected by line test	An error was detected in a remote station when a line test was performed.	Check if the remote station is operational and if some cable is disconnected or not.								
B307	Data link error on all stations	Prohibited SB was turned on.	Do not turn on prohibited SB.								
B308	Station number setting error (installation status)	The station number of a slave station is outside of the range between "1 and 64".	Set the station number of the slave station within the range between "1 and 64".								
B309	Station number overlap error	The station number of the connected module is overlapped (including occupied stations). However, duplication of the head station number is excluded.	Check the modules' station numbers.								
B30A	Installation error	The station type of the module is different from the parameter setting. Example) <table border="1" style="margin-left: 20px;"> <tr> <td>Connected module</td> <td>Parameter setting</td> </tr> <tr> <td>Remote device</td> <td>Remote I/O</td> </tr> <tr> <td>Remote device</td> <td>Remote I/O</td> </tr> <tr> <td></td> <td>Remote device</td> </tr> </table>	Connected module	Parameter setting	Remote device	Remote I/O	Remote device	Remote I/O		Remote device	Set a correct parameter.
Connected module	Parameter setting										
Remote device	Remote I/O										
Remote device	Remote I/O										
	Remote device										
B30B	Installation error	The actual installation status is different from the network parameter setting.	Make the actual installation status and the network parameter setting matched.								
B30D	Initial status	Line test request was issued before starting the link.	Issue the request after starting the data link.								
B310	Data link restart error	Prohibited SB was turned on.	Do not turn on prohibited SB.								
B311	Data link stop error	Prohibited SB was turned on.	Do not turn on prohibited SB.								

Table 9.1 Error Code List (3/6)

Error code (hexadecimal)	Error details	Cause of error occurrence (details)	Corrective action
B384	Station number setting error (parameter)	The network parameter is corrupted.	Perform the following procedures: (1) Correct the network parameter and write it to the PLC. (2) If the error persists after the correction, there is a hardware error on the safety master module. Consult your local Mitsubishi representative.
B385	Error in total number of stations (parameter)	The parameter for the total number of occupied stations set in the station information exceeded 64.	Perform the following procedures: (1) Correct the network parameter and write it to the PLC. (2) If the error persists after the correction, there is a hardware error on the safety master module. Consult your local Mitsubishi representative.
B386	Setting error in number of occupied stations (parameter)	All parameters for the number of occupied stations set in the station information was set to "0".	Perform the following procedures: (1) Correct the network parameter and write it to the PLC. (2) If the error persists after the correction, there is a hardware error on the safety master module. Consult your local Mitsubishi representative.
B388	Station type setting error (parameter)	The parameter for the station type in the station information was set to "other than 0 and 1".	Perform the following procedures: (1) Correct the network parameter and write it to the PLC. (2) If the error persists after the correction, there is a hardware error on the safety master module. Consult your local Mitsubishi representative.
B38B	Remote device station setting error (parameter)	The parameter for the number of remote device stations was set to "43 or more" in the station information.	Perform the following procedures: (1) Correct the network parameter and write it to the PLC. (2) If the error persists after the correction, there is a hardware error on the safety master module. Consult your local Mitsubishi representative.
B391	Retry count setting error (parameter)	The retry count parameter was set to a value other than "1 to 7".	Perform the following procedures: (1) Correct the network parameter and write it to the PLC. (2) If the error persists after the correction, there is a hardware error on the safety master module. Consult your local Mitsubishi representative.
B392	PLC down select error (parameter)	The network parameter is corrupted.	Perform the following procedures: (1) Correct the network parameter and write it to the PLC. (2) If the error persists after the correction, there is a hardware error on the safety master module. Consult your local Mitsubishi representative.

Table 9.1 Error Code List (4/6)

Error code Detectability (hexadecimal)	Error details	Cause of error occurrence (details)	Corrective action
B393	Scan mode setting error(parameter)	The network parameter is corrupted.	Perform the following procedures: (1) Correct the network parameter and write it to the PLC. (2) If the error persists after the correction, there is a hardware error on the safety master module. Consult your local Mitsubishi representative.
B394	Automatic reconnection station count setting error (parameter)	The parameter for the number of automatic return stations was set to a value other than "1 to 10".	Perform the following procedures: (1) Correct the network parameter and write it to the PLC. (2) If the error persists after the correction, there is a hardware error on the safety master module. Consult your local Mitsubishi representative.
B396	Station number overlap error (parameter)	A overlap station number was specified with the station information parameter.	Perform the following procedures: (1) Correct the network parameter and write it to the PLC. (2) If the error persists after the correction, there is a hardware error on the safety master module. Consult your local Mitsubishi representative.
B397	Station information setting error (parameter)	The station information parameter setting does not meet the following condition: $\{16 \times A + 54 \times (B + C)\} \leq 2304$ A: Number of standard remote I/O stations B: Number of remote device stations C: Number of safety remote I/O stations	Perform the following procedures: (1) Correct the network parameter and write it to the PLC. (2) If the error persists after the correction, there is a hardware error on the safety master module. Consult your local Mitsubishi representative.
B398	Exclusive station count setting error (parameter)	The number of occupied stations set as the station information parameter is outside the following range. • Safety remote station: 1 to 2 • Standard remote station: 1 to 4	Perform the following procedures: (1) Correct the network parameter and write it to the PLC. (2) If the error persists after the correction, there is a hardware error on the safety master module. Consult your local Mitsubishi representative.
B399	All connect count setting error (parameter)	The number of connected modules was set to a value other than "1 to 64".	Perform the following procedures: (1) Correct the network parameter and write it to the PLC. (2) If the error persists after the correction, there is a hardware error on the safety master module. Consult your local Mitsubishi representative.
B39B	Reserved station setting error	All stations were set as reserved stations.	Perform the following procedures: (1) Correct the network parameter and write it to the PLC. (2) If the error persists after the correction, there is a hardware error on the safety master module. Consult your local Mitsubishi representative.

Table 9.1 Error Code List (5/6)

Error code Detectability (hexadecimal)	Error details	Cause of error occurrence (details)	Corrective action
B400	System error	A system error was detected.	Perform the following procedures: (1) Check if the safety master module, safety power supply module, and safety CPU module are properly mounted on the safety base unit. (2) Check if the operation environment of the safety master module is within the general specifications for the safety CPU module. (3) Check if the power capacity is sufficient. (4) Check if the hardware of the safety master module, safety CPU module and safety base unit is normal, according to each manual. In the case of failure, please contact your local Mitsubishi service center or representative for repair. (5) If the problem is not resolved by the above, please consult your local Mitsubishi service center or representative, explaining a detailed description of the problem.
B500	System error	A system error was detected.	
B600	System error	A system error was detected.	
B700	System error	A system error was detected.	
B800	System error	A system error was detected.	
B900	System error	A system error was detected.	
BA00	System error	A system error was detected.	
BA19	Tested station error	Communication of the station being tested was disabled during line test 2.	Check the cables and the station.
BA1B	All stations error	Communication of all stations was disabled during line test 1.	Check the cables.
BA1E	RAM diagnostics error	In diagnosis of RAM, a hardware error was detected.	Perform the following procedures: (1) Check if the safety master module, safety power supply module, and safety CPU module are properly mounted on the safety base unit. (2) Check if the operation environment of the safety master module is within the general specifications for the safety CPU module. (3) Check if the power capacity is sufficient. (4) Check if the hardware of the safety master module, safety CPU module and safety base unit is normal, according to each manual. In the case of failure, please contact your local Mitsubishi service center or representative for repair. (5) If the problem is not resolved by the above, please consult your local Mitsubishi service center or representative, explaining a detailed description of the problem.
BA1F	RAM diagnostics error	In diagnosis of RAM, the value written to the target RAM is not matched with the read-out value.	
BB00	System error	A system error was detected.	(2) Check if the operation environment of the safety master module is within the general specifications for the safety CPU module. (3) Check if the power capacity is sufficient. (4) Check if the hardware of the safety master module, safety CPU module and safety base unit is normal, according to each manual. In the case of failure, please contact your local Mitsubishi service center or representative for repair. (5) If the problem is not resolved by the above, please consult your local Mitsubishi service center or representative, explaining a detailed description of the problem.

Table 9.1 Error Code List (6/6)

Error code Detectability (hexadecimal)	Error details	Cause of error occurrence (details)	Corrective action
BBC1	Mode setting error (parameter)	The network parameter is corrupted.	Perform the following procedures: (1) Correct the network parameter and write it to the PLC. (2) If the error persists after the correction, there is a hardware error on the safety master module. Consult your local Mitsubishi representative.
BBC2	Station number setting error (parameter)	The network parameter is corrupted.	Perform the following procedures: (1) Correct the network parameter and write it to the PLC. (2) If the error persists after the correction, there is a hardware error on the safety master module. Consult your local Mitsubishi representative.
BBC5	Master station overlapping error	Multiple master stations exist on the same line. Or, line noise was detected at power-on.	Reduce the number of master stations on the same line to one. Or, check the line status.
BBD3	CPU module type error	The installed CPU module is not a safety CPU module.	Check the CPU module installed.
BC00	System error	A system error was detected.	Perform the following procedures: (1) Check if the safety master module, safety power supply module, and safety CPU module are properly mounted on the safety base unit. (2) Check if the operation environment of the safety master module is within the general specifications for the safety CPU module. (3) Check if the power capacity is sufficient. (4) Check if the hardware of the safety master module, safety CPU module and safety base unit is normal, according to each manual. In the case of failure, please contact your local Mitsubishi service center or representative for repair. (5) If the problem is not resolved by the above, please consult your local Mitsubishi service center or representative, explaining a detailed description of the problem.
BD86	CPU error is detected	A hardware error is detected on any of the safety CPU module, safety master module and safety base.	
BF00	System error	A system error was detected.	

APPENDIX

Appendix 1 External Dimensions Diagram

This section describes the external dimensions of the QS0J61BT12.

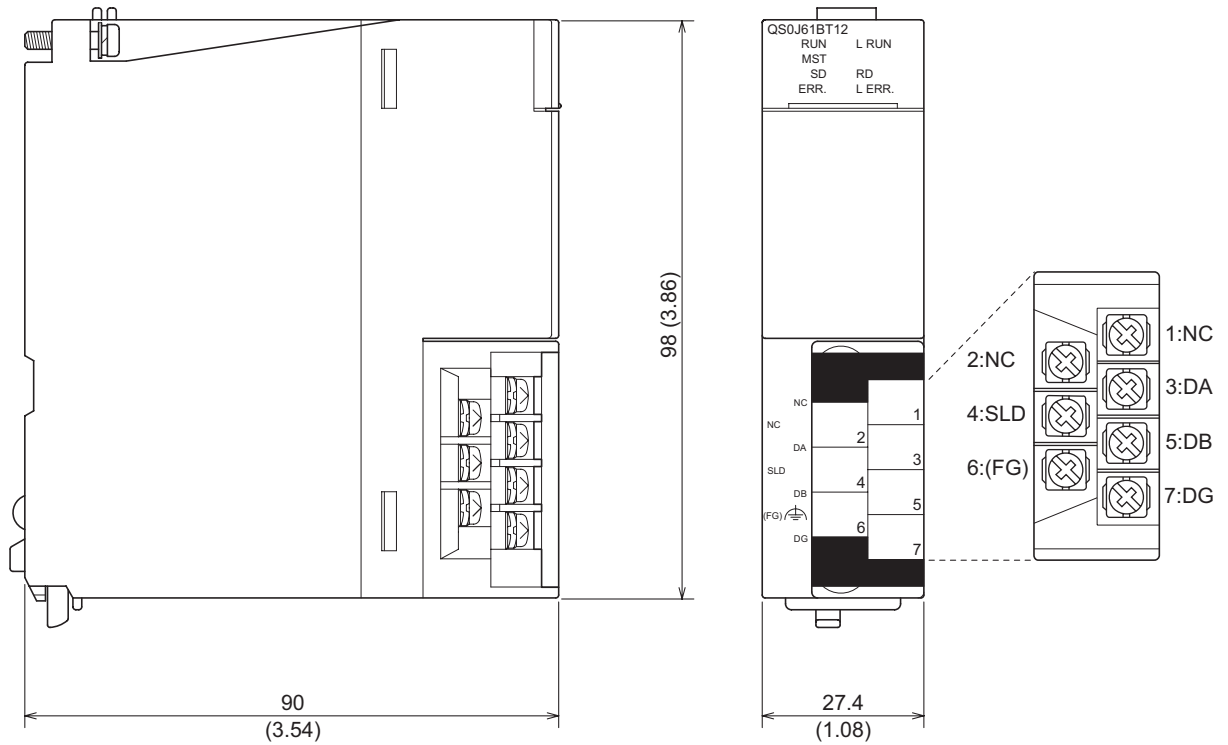

Unit: mm (inch)

Appendix 2 Transmission Delay Time when Module whose Serial Number (First Five Digits) is "10031" or Earlier is Included

When even one module whose serial number (first five digits) is "10031" or earlier is included in the system, which is configured with the safety CPU module, safety master module, and safety remote I/O stations (QS0J65BTB2-12DT), the calculation formula for transmission delay time (the length of time before data transmission is completed) between a safety master station and safety remote I/O stations will be as follows.

[Calculation formula]

- SM^{*1}: Sequence scan time of safety CPU module
- LS: Link scan time (Refer to Section 5.1.)
- n: (LS/SM) value that is rounded up to the nearest whole number
- m: {Safety refresh response processing time^{*2} / (SM × n)} value that is rounded up to the nearest whole number

* 1: For the calculation of SM, refer to the "QSCPU User's Manual (Function Explanation, Program Fundamentals)".

To use the constant scan function in the safety CPU module whose serial number (first five digits) is "10031" or earlier, set the value to be "the specified constant scan value + 2ms".

* 2: For the safety refresh response processing time and the safety remote station input/output response time, refer to the manual of the relevant safety remote I/O station.

(1) Safety refresh monitoring time

<Synchronous mode>

Safety refresh monitoring time \geq SM^{*1} + (SM × n) × 4 + (SM × n) × m [ms]

<Asynchronous mode>

Safety refresh monitoring time \geq SM^{*1} + (SM × n) × 4 + LS + (SM × n) × m [ms]

☒ POINT

When the safety CPU module detects CC-LINK DATA RECEPTION TIMEOUT (error code: 8320 to 8322), increase the safety refresh monitoring time as needed.

(2) Safety master station (RX) ← Safety remote I/O station (input)

[Normal value (CC-Link Safety line is stable.)]

SM + (SM × n) × 3 + (SM × n) × m + Safety remote station input response time^{*1} [ms]

[Normal value (CC-Link Safety line is unstable.)]

(Safety refresh monitoring time × 2) + Safety remote station input response time^{*1} - (SM × n) × 4 [ms]

(3) Safety master station (RY) → Safety remote I/O station (output)**[Normal value (CC-Link Safety line is stable.)]** $(SM \times n) + LS + (SM \times n) \times m + \text{Safety remote station output response time}^{*2}$ [ms]**[Normal value (CC-Link Safety line is unstable.)]** $(\text{Safety refresh monitoring time} \times 2) + \text{Safety remote station output response time}^{*1} - (SM \times n) \times 4$ [ms]**(4) Response performance****[Normal value]**

Input transmission delay + SM + Output transmission delay

- Input transmission delay = $SM + (SM \times n) \times 3 + (SM \times n) \times m + \text{Safety remote station input response time}$
- Output transmission delay = $(SM \times n) + LS + (SM \times n) \times m + \text{Safety remote station output response time}$

[Maximum value] $\text{Safety remote station input response time} + \{(\text{Safety refresh monitoring time} \times 3) - (SM \times n) \times 6\} + \text{Safety remote station output response time}$

INDEX

[A]		
Auto refresh function	4-9	
Automatic return function	4-20	
[C]		
CC-Link dedicated cable	3-3	
CC-Link diagnostics	9-21	
Communication across a network composed of safety remote stations and standard remote stations	4-6	
Communication with safety remote I/O stations	4-3	
Compatibility with CC-Link	1-2	
Compliance with the EMC and low voltage directives	A-12	
[D]		
Data link stop function at safety CPU error	4-21	
Details of input signals	8-3	
[E]		
Error history registration function	4-25	
External dimensions diagram	App-1	
[H]		
Handling Precautions	7-3	
Hardware Test	7-8	
H/W Information	9-24	
[I]		
Identifying the communication target station (remote I/O station)	4-12	
Internal current consumption	3-1	
I/O signal list	8-2	
[L]		
Led indicators	7-7	
Line test	9-23	
Link special registers(SW)	8-20	
Link Special Relays(SB)	8-17	
[M]		
Maximum overall cable distance	3-2	
[P]		
Performance specifications	3-1	
[R]		
Reserved station function	4-26	
[S]		
Safety remote station interlock function	4-30	
		Scan synchronization function 4-27
		Slave station cut-off function 4-18
		Slave station forced clear function at safety CPU stop 4-23
		Station number overlap checking function 4-17
[T]		
		T-Branch Connection 7-11

WARRANTY

Please confirm the following product warranty details before using this product.

1. Limited Warranty and Product Support.

- a. Mitsubishi Electric Company ("MELCO") warrants that for a period of eighteen (18) months after date of delivery from the point of manufacture or one year from date of Customer's purchase, whichever is less, Mitsubishi MELSEC Safety programmable controllers (the "Products") will be free from defects in material and workmanship.
- b. At MELCO's option, for those Products MELCO determines are not as warranted, MELCO shall either repair or replace them or issue a credit or return the purchase price paid for them.
- c. For this warranty to apply:
 - (1) Customer shall give MELCO (i) notice of a warranty claim to MELCO and the authorized dealer or distributor from whom the Products were purchased, (ii) the notice shall describe in reasonable details the warranty problem, (iii) the notice shall be provided promptly and in no event later than thirty (30) days after the Customer knows or has reason to believe that Products are not as warranted, and (iv) in any event, the notice must be given within the warranty period;
 - (2) Customer shall cooperate with MELCO and MELCO's representatives in MELCO's investigation of the warranty claim, including preserving evidence of the claim and its causes, meaningfully responding to MELCO's questions and investigation of the problem, grant MELCO access to witnesses, personnel, documents, physical evidence and records concerning the warranty problem, and allow MELCO to examine and test the Products in question offsite or at the premises where they are installed or used; and
 - (3) If MELCO requests, Customer shall remove Products it claims are defective and ship them to MELCO or MELCO's authorized representative for examination and, if found defective, for repair or replacement. The costs of removal, shipment to and from MELCO's designated examination point, and reinstallation of repaired or replaced Products shall be at Customer's expense.
 - (4) If Customer requests and MELCO agrees to effect repairs onsite at any domestic or overseas location, the Customer will pay for the costs of sending repair personnel and shipping parts. MELCO is not responsible for any re-commissioning, maintenance, or testing on-site that involves repairs or replacing of the Products.
- d. Repairs of Products located outside of Japan are accepted by MELCO's local authorized service facility centers ("FA Centers"). Terms and conditions on which each FA Center offers repair services for Products that are out of warranty or not covered by MELCO's limited warranty may vary.
- e. Subject to availability of spare parts, MELCO will offer Product repair services for (7) years after each Product model or line is discontinued, at MELCO's or its FA Centers' rates and charges and standard terms in effect at the time of repair. MELCO usually produces and retains sufficient spare parts for repairs of its Products for a period of seven (7) years after production is discontinued.
- f. MELCO generally announces discontinuation of Products through MELCO's Technical Bulletins. Products discontinued and repair parts for them may not be available after their production is discontinued.

2. Limits of Warranties.

- a. MELCO does not warrant or guarantee the design, specify, manufacture, construction or installation of the materials, construction criteria, functionality, use, properties or other characteristics of the equipment, systems, or production lines into which the Products may be incorporated, including any safety, fail-safe and shut down systems using the Products.
- b. MELCO is not responsible for determining the suitability of the Products for their intended purpose and use, including determining if the Products provide appropriate safety margins and redundancies for the applications, equipment or systems into which they are incorporated.
- c. Customer acknowledges that qualified and experienced personnel are required to determine the suitability, application, design, construction and proper installation and integration of the Products. MELCO does not supply such personnel.
- d. MELCO is not responsible for designing and conducting tests to determine that the Product functions appropriately and meets application standards and requirements as installed or incorporated into the end-user's equipment, production lines or systems.
- e. MELCO does not warrant any Product:
 - (1) repaired or altered by persons other than MELCO or its authorized engineers or FA Centers;
 - (2) subjected to negligence, carelessness, accident, misuse, or damage;
 - (3) improperly stored, handled, installed or maintained;
 - (4) integrated or used in connection with improperly designed, incompatible or defective hardware or software;
 - (5) that fails because consumable parts such as batteries, backlights, or fuses were not tested, serviced or replaced;
 - (6) operated or used with equipment, production lines or systems that do not meet applicable and commensurate legal, safety and industry-accepted standards;
 - (7) operated or used in abnormal applications;
 - (8) installed, operated or used in contravention of instructions, precautions or warnings contained in MELCO's user, instruction and/or safety manuals, technical bulletins and guidelines for the Products;
 - (9) used with obsolete technologies or technologies not fully tested and widely accepted and in use at the time of the Product's manufacture;
 - (10) subjected to excessive heat or moisture, abnormal voltages, shock, excessive vibration, physical damage or other improper environment; or
 - (11) damaged or malfunctioning due to Acts of God, fires, acts of vandals, criminals or terrorists, communication or power failures, or any other cause or failure that results from circumstances beyond MELCO's control.
- f. All Product information and specifications contained on MELCO's website and in catalogs, manuals, or technical information materials provided by MELCO are subject to change without prior notice.

- g. The Product information and statements contained on MELCO's website and in catalogs, manuals, technical bulletins or other materials provided by MELCO are provided as a guide for Customer's use. They do not constitute warranties and are not incorporated in the contract of sale for the Products.
- h. These terms and conditions constitute the entire agreement between Customer and MELCO with respect to warranties, remedies and damages and supersede any other understandings, whether written or oral, between the parties. Customer expressly acknowledges that any representations or statements made by MELCO or others concerning the Products outside these terms are not part of the basis of the bargain between the parties and are not factored into the pricing of the Products.
- i. THE WARRANTIES AND REMEDIES SET FORTH IN THESE TERMS ARE THE EXCLUSIVE AND ONLY WARRANTIES AND REMEDIES THAT APPLY TO THE PRODUCTS.
- j. MELCO DISCLAIMS THE IMPLIED WARRANTIES OF MERCHANTABILITY AND FITNESS FOR A PARTICULAR PURPOSE.

3. Limits on Damages.

- a. MELCO'S MAXIMUM CUMULATIVE LIABILITY BASED ON ANY CLAIMS FOR BREACH OF WARRANTY OR CONTRACT, NEGLIGENCE, STRICT TORT LIABILITY OR OTHER THEORIES OF RECOVERY REGARDING THE SALE, REPAIR, REPLACEMENT, DELIVERY, PERFORMANCE, CONDITION, SUITABILITY, COMPLIANCE, OR OTHER ASPECTS OF THE PRODUCTS OR THEIR SALE, INSTALLATION OR USE SHALL BE LIMITED TO THE PRICE PAID FOR PRODUCTS NOT AS WARRANTED.
- b. Although MELCO has obtained the certification for Product's compliance to the international safety standards IEC61508 and EN954-1/ISO13849-1 from TUV Rheinland, this fact does not guarantee that Product will be free from any malfunction or failure. The user of this Product shall comply with any and all applicable safety standard, regulation or law and take appropriate safety measures for the system in which the Product is installed or used and shall take the second or third safety measures other than the Product. MELCO is not liable for damages that could have been prevented by compliance with any applicable safety standard, regulation or law.
- c. MELCO prohibits the use of Products with or in any application involving power plants, trains, railway systems, airplanes, airline operations, other transportation systems, amusement equipments, hospitals, medical care, dialysis and life support facilities or equipment, incineration and fuel devices, handling of nuclear or hazardous materials or chemicals, mining and drilling, and other applications where the level of risk to human life, health or property are elevated.
- d. MELCO SHALL NOT BE LIABLE FOR SPECIAL, INCIDENTAL, CONSEQUENTIAL, INDIRECT OR PUNITIVE DAMAGES, FOR LOSS OF PROFITS, SALES, OR REVENUE, FOR INCREASED LABOR OR OVERHEAD COSTS, FOR DOWNTIME OR LOSS OF PRODUCTION, FOR COST OVERRUNS, OR FOR ENVIRONMENTAL OR POLLUTION DAMAGES OR CLEAN-UP COSTS, WHETHER THE LOSS IS BASED ON CLAIMS FOR BREACH OF CONTRACT OR WARRANTY, VIOLATION OF STATUTE, NEGLIGENCE OR OTHER TORT, STRICT LIABILITY OR OTHERWISE.
- e. In the event that any damages which are asserted against MELCO arising out of or relating to the Products or defects in them, consist of personal injury, wrongful death and/or physical property damages as well as damages of a pecuniary nature, the disclaimers and limitations contained in these terms shall apply to all three types of damages to the fullest extent permitted by law. If, however, the personal injury, wrongful death and/or physical property damages cannot be disclaimed or limited by law or public policy to the extent provided by these terms, then in any such event the disclaimer of and limitations on pecuniary or economic consequential and incidental damages shall nevertheless be enforceable to the fullest extent allowed by law.
- f. In no event shall any cause of action arising out of breach of warranty or otherwise concerning the Products be brought by Customer more than one year after the cause of action accrues.
- g. Each of the limitations on remedies and damages set forth in these terms is separate and independently enforceable, notwithstanding the unenforceability or failure of essential purpose of any warranty, undertaking, damage limitation, other provision of these terms or other terms comprising the contract of sale between Customer and MELCO.

4. Delivery/Force Majeure.

- a. Any delivery date for the Products acknowledged by MELCO is an estimated and not a promised date. MELCO will make all reasonable efforts to meet the delivery schedule set forth in Customer's order or the purchase contract but shall not be liable for failure to do so.
- b. Products stored at the request of Customer or because Customer refuses or delays shipment shall be at the risk and expense of Customer.
- c. MELCO shall not be liable for any damage to or loss of the Products or any delay in or failure to deliver, service, repair or replace the Products arising from shortage of raw materials, failure of suppliers to make timely delivery, labor difficulties of any kind, earthquake, fire, windstorm, flood, theft, criminal or terrorist acts, war, embargoes, governmental acts or rulings, loss or damage or delays in carriage, acts of God, vandals or any other circumstances reasonably beyond MELCO's control.

5. Choice of Law/Jurisdiction.

These terms and any agreement or contract between Customer and MELCO shall be governed by the laws of the State of New York without regard to conflicts of laws. To the extent any action or dispute is not arbitrated, the parties consent to the exclusive jurisdiction and venue of the federal and state courts located in the Southern District of the State of New York. Any judgment there obtained may be enforced in any court of competent jurisdiction.

6. Arbitration.

Any controversy or claim arising out of, or relating to or in connection with the Products, their sale or use or these terms, shall be settled by arbitration conducted in accordance with the Center for Public Resources (CPR) Rules for Non-Administered Arbitration of International Disputes, by a sole arbitrator chosen from the CPR's panels of distinguished neutrals. Judgment upon the award rendered by the Arbitrator shall be final and binding and may be entered by any court having jurisdiction thereof. The place of the arbitration shall be New York City, New York. The language of the arbitration shall be English. The neutral organization designated to perform the functions specified in Rule 6 and Rules 7.7(b), 7.8 and 7.9 shall be the CPR.

SH(NA)-080600ENG-D(1006)MEE

MODEL: QS0J61BT12-U-SY-E

MODEL CODE: 13JR88

MITSUBISHI ELECTRIC CORPORATION

HEAD OFFICE : TOKYO BUILDING, 2-7-3 MARUNOUCHI, CHIYODA-KU, TOKYO 100-8310, JAPAN
NAGOYA WORKS : 1-14, YADA-MINAMI 5-CHOME, HIGASHI-KU, NAGOYA, JAPAN

When exported from Japan, this manual does not require application to the
Ministry of Economy, Trade and Industry for service transaction permission.

Specifications subject to change without notice.