

MITSUBISHI *Changes for the Better*
 PROGRAMMABLE CONTROLLERS
 MELSEC-F

FX3G-2AD-BD

INSTALLATION MANUAL

Manual Number	JY997D33501
Revision	B
Date	September 2008

This manual describes the part names, dimensions, mounting, and specifications of the product. Before use, read this manual and the manuals of all relevant products fully to acquire proficiency in handling and operating the product. Make sure to learn all the product information, safety information, and precautions. Store this manual in a safe place so that it can be taken out and read whenever necessary. Always forward it to the end user. Registration: The company and product names described in this manual are registered trademarks or the trademarks of their respective companies. Effective September 2008. Specifications are subject to change without notice. © 2008 Mitsubishi Electric Corporation

1. Outline

The FX3G-2AD-BD boards for analog input (hereinafter called 2AD-BD) is an expansion boards to add two analog input points.

1.1 Incorporated Items

Product	Analog input expansion board FX3G-2AD-BD
Included items	M3×8 tapping screws for installation: 2 pcs. Side cover Installation Manual (This manual)

1.2 External Dimensions, Part Names

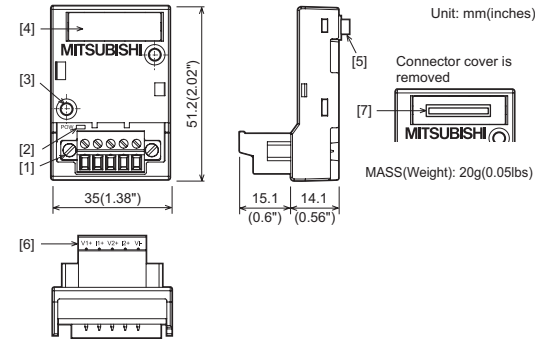

- [1] Terminal block mounting screws
- [2] POW LED: Lit while power is properly supplied from main unit
- [3] Mounting holes (2-φ3.2)
- [4] Connector cover
- [5] Main unit connector
- [6] Terminal block to connect analog input
- [7] Memory cassette/Display module connector

1.2.1 Terminal Layout

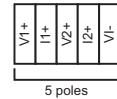

2. Installation

For installation/uninstallation details, refer to the following manuals:
 → Refer to the FX3G Series User's Manual - Hardware Edition.

INSTALLATION PRECAUTIONS **⚠ DANGER**

- Make sure to cut off all phases of the power supply externally before attempting installation or wiring work. Failure to do so may cause electric shock or damage to the product.

INSTALLATION PRECAUTIONS **⚠ CAUTION**

- Use the product within the generic environment specifications described in PLC main unit manual (Hardware Edition). Never use the product in areas with excessive dust, oily smoke, conductive dusts, corrosive gas (salt air, Cl₂, H₂S, SO₂, or NO₂), flammable gas, vibration or impacts, or exposed to high temperature, condensation, or rain and wind. If the product is used in such conditions, electric shock, fire, malfunctions, deterioration or damage may occur.
- When drilling screw holes or wiring, make sure cutting or wire debris does not enter the ventilation slits. Failure to do so may cause fire, equipment failures or malfunctions.
- Do not touch the conductive parts of the product directly. Doing so may cause device failures or malfunctions.
- Connect expansion board securely to their designated connectors. Loose connections may cause malfunctions.

The following section describes the installation method for the FX3G Series PLC (FX3G-40M□). In this example, Turn off the power to the PLC before installation. For more details on installation and removal, refer to the PLC main unit manual. → Refer to the FX3G Series User's Manual - Hardware Edition

2.1 Installation Method

- Remove the top cover (A in the right figure) or top cover (S) (A' in the right figure). In a 14/24-point type main unit, only the top cover (A in the right figure) is provided.
- Attach the accessory side cover (B in the right figure). Attachment of the side cover (B in the right figure) is not necessary when installing the FX3G-2AD-BD to only under the top cover (S) of a 40/60-point type main unit.
- Make sure the expansion board is in parallel with the main unit and attach it to the optional equipment connector.
- Fix the expansion board to the main unit using the provided M3 tapping screws. (2 places)
Tightening torque : 0.3 to 0.6 N-m

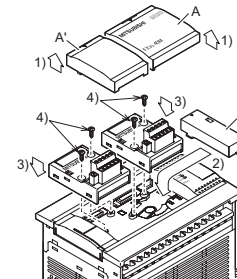

3. Wiring

WIRING PRECAUTIONS **⚠ DANGER**

- Make sure to cut off all phases of the power supply externally before attempting installation or wiring work. Failure to do so may cause electric shock or damage to the product.

WIRING PRECAUTIONS **⚠ CAUTION**

- Make sure to cut off all phases of the power supply externally before attempting installation or wiring work. Failure to do so may cause electric shock or damage to the product.
- Make sure to observe the following precautions in order to prevent any damage to the machinery or accidents due to abnormal data written to the PLC under the influence of noise:
 - Do not bundle the main circuit line together with or lay it close to the main circuit, high-voltage line or load line. Otherwise, noise disturbance and/or surge induction are likely to take place. As a guideline, lay the control line at least 100mm (3.94") or more away from the main circuit or high-voltage lines.
 - Ground the shield wire or shield of the shielded cable at one point on the PLC. However, do not use common grounding with heavy electrical systems.
- Make sure to properly wire to the European terminal board in accordance with the following precautions. Failure to do so may cause electric shock, a short-circuit, wire breakage, or damage to the product.
 - The disposal size of the cable end should be 9mm (0.35").
 - Tightening torque should be between 0.22 and 0.25N-m.
 - Twist the end of strand wire and make sure that there are no loose wires.
 - Do not solder-plate the electric wire ends.
 - Do not connect more than the specified number of wires or electric wires of unspecified size.
 - Affix the electric wires so that neither the terminal block nor the connected parts are directly stressed.
- Make sure to properly wire to the FX3G Series PLC in accordance with the following precautions. Failure to do so may cause electric shock, a short-circuit, wire breakage, or damage to this manual.
 - The disposal size of the cable end should follow the dimensions described in this manual.
 - Tightening torque should follow the specifications in this manual.

3.1 Applicable Cable and Terminal Tightening Torque

3.1.1 Terminal block (European type)

- Wire size
Wiring to analog device should use 20-22 AWG wire.
- Applicable cable

Type	Wire size
Single-wire	0.3mm ² to 0.5mm ² (AWG22 to 20)
2-wire	2 pieces of 0.3mm ² (AWG22)

- Termination of cable end
Strip the coating of strand wire and twist the cable core before connecting it, or strip the coating of single wire before connecting it. An alternative connection is to use a ferrule with insulating sleeve.

Manufacturer	Model	Pressure bonding tool
Phoenix Contact Co., Ltd.	AI 0.5-8WH	CRIMPFOX ZA 3 (or CRIMPFOX UD 6)

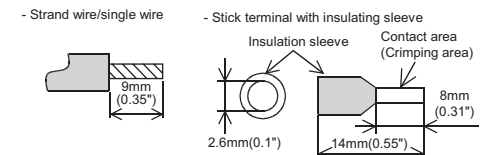

When using a stick terminal with insulating sleeve, choose a wire with proper cable sheath referring to the above outside dimensions, or otherwise, the wire cannot be inserted easily. The tightening torque must be 0.22 to 0.25N-m.

Safety Precaution (Read these precautions before use.)

This manual classifies the safety precautions into two categories:

⚠ DANGER and ⚠ CAUTION.

⚠ DANGER	Indicates that incorrect handling may cause hazardous conditions, resulting in death or severe injury.
⚠ CAUTION	Indicates that incorrect handling may cause hazardous conditions, resulting in medium or slight personal injury or physical damage.

Depending on the circumstances, procedures indicated by ⚠ CAUTION may also cause severe injury. It is important to follow all precautions for personal safety.

Associated Manuals

Manual name	Manual No.	Description
FX3G/FX3U/FX3UC Series User's Manual - Analog Control Edition	JY997D16701 MODEL CODE: 09R619	Describes specifications for analog control and programming method for FX3G/FX3U/FX3UC Series PLC.
FX3G Series User's Manual - Hardware Edition	JY997D31301 MODEL CODE: 09R521	Explains FX3G Series PLC specifications for I/O, wiring, installation, and maintenance.

How to obtain manuals

For product manuals or documents, consult with the Mitsubishi Electric dealer from who you purchased your product.

4) Tool

For tightening the terminal, use a commercially available small screwdriver having a straight form that is not widened toward the end as shown right.

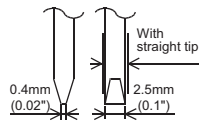

Caution :

If the diameter of screwdriver grip is too small, tightening torque will not be able to be achieved. Use the following recommended screwdriver or an appropriate replacement (grip diameter: approximately 25mm (0.98")).

Manufacturer	Model
Phoenix Contact Co., Ltd.	SZS 0.4×2.5

3.2 Wiring of Analog Input

→ For the terminal configuration, refer to Section 1.2

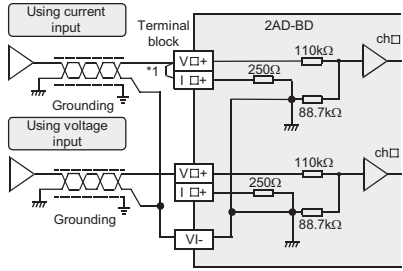

V□+, I□+, ch □: □ represents the channel number.

*1 Make sure to short-circuit the 'V□+' and 'I□+' terminals when current is input. (□: input channel number)

3.2.1 Cautions

- 1) Make sure to short-circuit the 'V□+' and 'I□+' terminals when ch is not used.
- 2) Use 2-core shielded twisted pair cable for the analog input lines, and separate the analog input lines from other power lines or inductive lines.
- 3) The grounding resistance should be 100Ω or less.

3.3 Grounding

Grounding should be performed as stated below.

- The grounding resistance should be 100Ω or less.
- Independent grounding should be performed for best results. When independent grounding is not performed, perform "shared grounding" of the following figure.

→ For details, refer to the FX3G Series User's Manual - Hardware Edition.

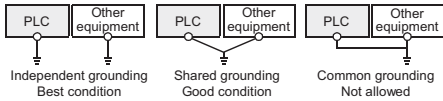

- The grounding wire size should be AWG 22-20 (0.3-0.5 mm²).
- The grounding point should be close to the PLC, and all grounding wire should be as short as possible.

4. Specifications

STARTUP AND MAINTENANCE PRECAUTIONS	CAUTION
<ul style="list-style-type: none"> • Do not disassemble or modify the PLC. Doing so may cause fire, equipment failures, or malfunctions. * For repair, contact your local Mitsubishi Electric distributor. • Do not drop the product or exert strong impact to it. Doing so may cause damage. 	

DISPOSAL PRECAUTIONS	CAUTION
<ul style="list-style-type: none"> • Please contact a certified electronic waste disposal company for the environmentally safe recycling and disposal of your device. 	

TRANSPORT AND STORAGE PRECAUTIONS	CAUTION
<ul style="list-style-type: none"> • The product is a precision instrument. During transportation, avoid any impacts. Failure to do so may cause failures in the product. After transportation, verify the operations of the product. 	

4.1 Applicable PLC

Model name	Applicability
FX3G Series PLC	Ver. 1.10 or later

The version number can be checked by monitoring D8001 as the last three digits indicate it.

- The number of connectable expansion boards varies depending on the main unit as follows:
FX3G-14M□, 24M□ Main units : 1 unit
FX3G-40M□, 60M□ Main units : 2 units
Never stack up two or more expansion boards.

For details on the system configuration, refer to the following manual.

→ Refer to the FX3G/FX3U/FX3UC Series User's Manual - Analog Control Edition

4.2 General Specifications

The general specifications are equivalent to the PLC main unit.

For general specifications, refer to the following manuals.

→ Refer to the FX3G Series User's Manual - Hardware Edition

4.3 Performance Specifications

Item	Specifications	
	Voltage input	Current input
Analog input range	0 to 10V DC (Input resistance: 198.7kΩ)	4 to 20mA DC (Input resistance: 250 Ω)
Maximum absolute input	-0.5V,+15V	-2mA,+30mA
Digital output	12 bits, binary	11 bits, binary
Resolution	2.5mV(10V/4000)	8μA(16mA/2000)
Total accuracy	<ul style="list-style-type: none"> • ±0.5% (±50mV) for full scale of 10V (when ambient temperature is 25°C±5°C) • ±1.0% (±100mV) for full scale of 10V (when ambient temperature is 0°C to 55°C) 	<ul style="list-style-type: none"> • ±0.5% (±80μA) for full scale of 16mA (when ambient temperature is 25°C±5°C) • ±1.0% (±160μA) for full scale of 16mA (when ambient temperature is 0°C to 55°C)
A/D conversion time	180μs (The data will be updated at every scan time of the PLC.)	
Input characteristics		
Insulation method	No insulation between each channel or the PLC.	
Occupied points	0 point (This number is not related to the maximum number of input/output points of the PLC.)	

4.4 List of Special Devices

R: Read W: Write

	Device number		Description	R/W
	BD1	BD2		
Special auxiliary relay	M8260	M8270	Switches the input mode of channel 1 OFF: Voltage input ON: Current input	R/W
	M8261	M8271	Switches the input mode of channel 2 OFF: Voltage input ON: Current input	R/W
Special data register	D8260	D8270	Channel -1 input data	R
	D8261	D8271	Channel -2 input data	R
	D8264	D8274	Averaging time for channel-1 (Settingrange: 1 to 4095)	R/W
	D8265	D8275	Averaging time for channel-2 (Settingrange: 1 to 4095)	R/W
	D8268	D8278	Error status b0: Channel-1 over-scale detection b1: Channel-2 over-scale detection b2: Unused b3: Unused b4: EEPROM error b5: Averaging time setting error b6: 2AD-BD hardware error b7: 2AD-BD communication data error b15 to b8: Unused	R/W
	D8269	D8279	Model code = 3	R

As for the details of the special devices, refer to following manual.

→ Refer to the FX3G/FX3U/FX3UC Series User's Manual - Analog Control Edition

This manual confers no industrial property rights or any rights of any other kind, nor does it confer any patent licenses. Mitsubishi Electric Corporation cannot be held responsible for any problems involving industrial property rights which may occur as a result of using the contents noted in this manual.

Warning

Mitsubishi will not be held liable for damage caused by factors found not to be the cause of Mitsubishi; opportunity loss or lost profits caused by faults in the Mitsubishi products; damage, secondary damage, accident compensation caused by special factors unpredictable by Mitsubishi; damages to products other than Mitsubishi products; and to other duties.

⚠ For safe use

- This product has been manufactured as a general-purpose part for general industries, and has not been designed or manufactured to be incorporated in a device or system used in purposes related to human life.
- Before using the product for special purposes such as nuclear power, electric power, aerospace, medicine or passenger movement vehicles, consult with Mitsubishi Electric.
- This product has been manufactured under strict quality control. However when installing the product where major accidents or losses could occur if the product fails, install appropriate backup or failsafe functions in the system.

MITSUBISHI ELECTRIC CORPORATION

HEAD OFFICE : TOKYO BUILDING, 2-7-3 MARUNOUCHI, CHIYODA-KU, TOKYO 100-8310, JAPAN
HIMEJI WORKS : 840, CHIYODA CHO, HIMEJI, JAPAN

MITSUBISHI *Changes for the Better*
 PROGRAMMABLE CONTROLLERS
FX3G-2AD-BD
INSTALLATION MANUAL

Manual Number	JY997D33501
Revision	B
Date	September 2008

This manual describes the part names, dimensions, mounting, and specifications of the product. Before use, read this manual and the manuals of all relevant products fully to acquire proficiency in handling and operating the product. Make sure to learn all the product information, safety information, and precautions. Store this manual in a safe place so that it can be taken out and read whenever necessary. Always forward it to the end user.

Registration:
 The company and product names described in this manual are registered trademarks or the trademarks of their respective companies.

Effective September 2008
 Specifications are subject to change without notice.
 © 2008 Mitsubishi Electric Corporation

Safety Precaution (Read these precautions before use.)
 This manual classifies the safety precautions into two categories:
 ⚠️ DANGER and ⚠️ CAUTION.

DANGER	Indicates that incorrect handling may cause hazardous conditions, resulting in death or severe injury.
CAUTION	Indicates that incorrect handling may cause hazardous conditions, resulting in medium or slight personal injury or physical damage.

Depending on the circumstances, procedures indicated by ⚠️ CAUTION may also cause severe injury. It is important to follow all precautions for personal safety.

Associated Manuals

Manual name	Manual No.	Description
FX3G/FX3U/FX3UC Series User's Manual - Analog Control Edition	JY997D16701 MODEL CODE: 09R619	Describes specifications for analog control and programming method for FX3G/FX3U/FX3UC Series PLC.
FX3G Series User's Manual - Hardware Edition	JY997D31301 MODEL CODE: 09R521	Explains FX3G Series PLC specifications for I/O, wiring, installation, and maintenance.

How to obtain manuals
 For product manuals or documents, consult with the Mitsubishi Electric dealer from who you purchased your product.

1. Outline
 The FX3G-2AD-BD boards for analog input (hereinafter called 2AD-BD) is an expansion boards to add two analog input points.

1.1 Incorporated Items

Product	Analog input expansion board FX3G-2AD-BD
Included items	M3x8 tapping screws for installation: 2 pcs. Side cover Installation Manual (This manual)

1.2 External Dimensions, Part Names

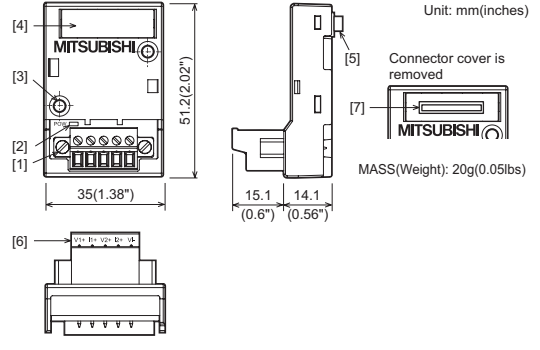

- [1] Terminal block mounting screws
- [2] POW LED: Lit while power is properly supplied from main unit
- [3] Mounting holes (2-φ3.2)
- [4] Connector cover
- [5] Main unit connector
- [6] Terminal block to connect analog input
- [7] Memory cassette/Display module connector



2. Installation
 For installation/uninstallation details, refer to the following manuals:
 → Refer to the FX3G Series User's Manual - Hardware Edition.

INSTALLATION PRECAUTIONS ⚠️ DANGER

- Make sure to cut off all phases of the power supply externally before attempting installation or wiring work. Failure to do so may cause electric shock or damage to the product.

INSTALLATION PRECAUTIONS ⚠️ CAUTION

- Use the product within the generic environment specifications described in PLC main unit manual (Hardware Edition). Never use the product in areas with excessive dust, oily smoke, conductive dusts, corrosive gas (salt air, Cl₂, H₂S, SO₂, or NO₂), flammable gas, vibration or impacts, or exposed to high temperature, condensation, or rain and wind. If the product is used in such conditions, electric shock, fire, malfunctions, deterioration or damage may occur.
- When drilling screw holes or wiring, make sure cutting or wire debris does not enter the ventilation slits. Failure to do so may cause fire, equipment failures or malfunctions.
- Do not touch the conductive parts of the product directly. Doing so may cause device failures or malfunctions.
- Connect expansion board securely to their designated connectors. Loose connections may cause malfunctions.

The following section describes the installation method for the FX3G Series PLC (FX3G-40M□). In this example, Turn off the power to the PLC before installation. For more details on installation and removal, refer to the PLC main unit manual.
 → Refer to the FX3G Series User's Manual - Hardware Edition

2.1 Installation Method

- Remove the top cover (A in the right figure) or top cover (S) (A in the right figure). In a 14/24-point type main unit, only the top cover (A in the right figure) is provided.
- Attach the accessory side cover (B in the right figure). Attachment of the side cover (B in the right figure) is not necessary when installing the FX3G-2AD-BD to only under the top cover (S) of a 40/60-point type main unit.
- Make sure the expansion board is in parallel with the main unit and attach it to the optional equipment connector.
- Fix the expansion board to the main unit using the provided M3 tapping screws. (2 places)
Tightening torque : 0.3 to 0.6 N·m

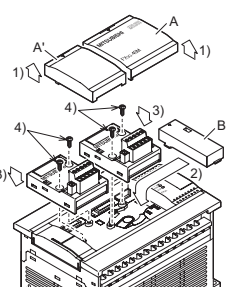

3. Wiring

WIRING PRECAUTIONS ⚠️ DANGER

- Make sure to cut off all phases of the power supply externally before attempting installation or wiring work. Failure to do so may cause electric shock or damage to the product.

WIRING PRECAUTIONS ⚠️ CAUTION

- Make sure to cut off all phases of the power supply externally before attempting installation or wiring work. Failure to do so may cause electric shock or damage to the product.
- Make sure to observe the following precautions in order to prevent any damage to the machinery or accidents due to abnormal data written to the PLC under the influence of noise:
 - Do not bundle the main circuit line together with or lay it close to the main circuit, high-voltage line or load line. Otherwise, noise disturbance and/or surge induction are likely to take place. As a guideline, lay the control line at least 100mm (3.94") or more away from the main circuit or high-voltage lines.
 - Ground the shield wire or shield of the shielded cable at one point on the PLC. However, do not use common grounding with heavy electrical systems.
- Make sure to properly wire to the European terminal board in accordance with the following precautions. Failure to do so may cause electric shock, a short-circuit, wire breakage, or damage to the product.
 - The disposal size of the cable end should be 9mm (0.35").
 - Tightening torque should be between 0.22 and 0.25N·m.
 - Do not twist the end of strand wire and make sure that there are no loose wires.
 - Do not solder-plate the electric wire ends.
 - Do not connect more than the specified number of wires or electric wires of unspecified size.
 - Affix the electric wires so that neither the terminal block nor the connected parts are directly stressed.
- Make sure to properly wire to the FX3G Series PLC in accordance with the following precautions. Failure to do so may cause electric shock, a short-circuit, wire breakage, or damage to the product.
 - The disposal size of the cable end should follow the dimensions described in this manual.
 - Tightening torque should follow the specifications in this manual.

3.1 Applicable Cable and Terminal Tightening Torque

- 3.1.1 Terminal block (European type)**
- Wire size
Wiring to analog device should use 20-22 AWG wire.
 - Applicable cable

Type	Wire size
Single-wire	0.3mm ² to 0.5mm ² (AWG22 to 20)
2-wire	2 pieces of 0.3mm ² (AWG22)

- Termination of cable end
Strip the coating of strand wire and twist the cable core before connecting it, or strip the coating of single wire before connecting it. An alternative connection is to use a ferrule with insulating sleeve.

Manufacturer	Model	Pressure bonding tool
Phoenix Contact Co., Ltd.	AI 0.5-8WH	CRIMPFOX ZA 3 (or CRIMPFOX UD 6)

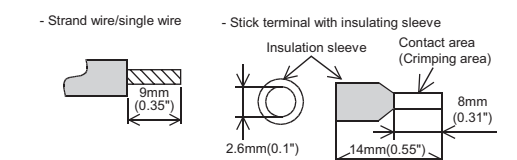

When using a stick terminal with insulating sleeve, choose a wire with proper cable sheath referring to the above outside dimensions, or otherwise, the wire cannot be inserted easily. The tightening torque must be 0.22 to 0.25N·m.

4) Tool
 For tightening the terminal, use a commercially available small screwdriver having a straight form that is not widened toward the end as shown right.
Caution :
 If the diameter of screwdriver grip is too small, tightening torque will not be able to be achieved. Use the following recommended screwdriver or an appropriate replacement (grip diameter: approximately 25mm (0.98")).

Manufacturer	Model
Phoenix Contact Co., Ltd.	SZS 0.4x2.5

3.2 Wiring of Analog Input
 → For the terminal configuration, refer to Section 1.2

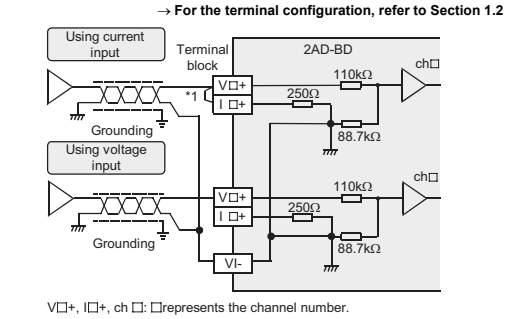

V□+, I□+, ch □: □ represents the channel number.
 *1 Make sure to short-circuit the 'V□+' and 'I□+' terminals when current is input. (□: input channel number)

- 3.2.1 Cautions**
- Make sure to short-circuit the 'V□+' and 'I□+' terminals when ch is not used.
 - Use 2-core shielded twisted pair cable for the analog input lines, and separate the analog input lines from other power lines or inductive lines.
 - The grounding resistance should be 100Ω or less.

3.3 Grounding

Grounding should be performed as stated below.

- The grounding resistance should be 100Ω or less.
- Independent grounding should be performed for best results. When independent grounding is not performed, perform "shared grounding" of the following figure.

→ For details, refer to the FX3G Series User's Manual - Hardware Edition.

- The grounding wire size should be AWG 22-20 (0.3-0.5 mm²).
- The grounding point should be close to the PLC, and all grounding wire should be as short as possible.

4. Specifications

STARTUP AND MAINTENANCE PRECAUTIONS ⚠️ CAUTION

- Do not disassemble or modify the PLC. Doing so may cause fire, equipment failures, or malfunctions. * For repair, contact your local Mitsubishi Electric distributor.
- Do not drop the product or exert strong impact to it. Doing so may cause damage.

DISPOSAL PRECAUTIONS ⚠️ CAUTION

- Please contact a certified electronic waste disposal company for the environmentally safe recycling and disposal of your device.

TRANSPORT AND STORAGE PRECAUTIONS ⚠️ CAUTION

- The product is a precision instrument. During transportation, avoid any impacts. Failure to do so may cause failures in the product. After transportation, verify the operations of the product.

4.1 Applicable PLC

Model name	Applicability
FX3G Series PLC	Ver. 1.10 or later

The version number can be checked by monitoring D8001 as the last three digits indicate it.

- The number of connectable expansion boards varies depending on the main unit as follows:
 FX3G-14M□, 24M□ Main units : 1 unit
 FX3G-40M□, 60M□ Main units : 2 units
 Never stack up two or more expansion boards.

For details on the system configuration, refer to the following manual.
 → Refer to the FX3G/FX3U/FX3UC Series User's Manual - Analog Control Edition

4.2 General Specifications

The general specifications are equivalent to the PLC main unit. For general specifications, refer to the following manuals.
 → Refer to the FX3G Series User's Manual - Hardware Edition

4.3 Performance Specifications

Item	Specifications	
	Voltage input	Current input
Analog input range	0 to 10V DC (Input resistance: 198.7kΩ)	4 to 20mA DC (Input resistance: 250 Ω)
Maximum absolute input	-0.5V,+15V	-2mA,+30mA
Digital output	12 bits, binary	11 bits, binary
Resolution	2.5mV(10V/4000)	8μA(16mA/2000)
Total accuracy	<ul style="list-style-type: none"> ±0.5% (±50mV) for full scale of 10V (when ambient temperature is 25°C±5°C) ±1.0% (±100mV) for full scale of 10V (when ambient temperature is 0°C to 55°C) 	<ul style="list-style-type: none"> ±0.5% (±80μA) for full scale of 16mA (when ambient temperature is 25°C±5°C) ±1.0% (±160μA) for full scale of 16mA (when ambient temperature is 0°C to 55°C)
A/D conversion time	180μs (The data will be updated at every scan time of the PLC.)	
Input characteristics		
Insulation method	No insulation between each channel or the PLC.	
Occupied points	0 point (This number is not related to the maximum number of input/output points of the PLC.)	

4.4 List of Special Devices

Device number	Device number		Description	R/W
	BD1	BD2		
Special auxiliary relay	M8260	M8270	Switches the input mode of channel 1 OFF: Voltage input ON: Current input	R/W
	M8261	M8271	Switches the input mode of channel 2 OFF: Voltage input ON: Current input	R/W
Special data register	D8260	D8270	Channel -1 input data	R
	D8261	D8271	Channel -2 input data	R
	D8264	D8274	Averaging time for channel-1 (Settingrange: 1 to 4095)	R/W
	D8265	D8275	Averaging time for channel-2 (Settingrange: 1 to 4095)	R/W
	D8268	D8278	Error status b0: Channel-1 over-scale detection b1: Channel-2 over-scale detection b2: Unused b3: Unused b4: EEPROM error b5: Averaging time setting error b6: 2AD-BD hardware error b7: 2AD-BD communication data error b15 to b8: Unused	R/W
	D8269	D8279	Model code = 3	R

As for the details of the special devices, refer to following manual.
 → Refer to the FX3G/FX3U/ FX3UC Series User's Manual - Analog Control Edition

This manual confers no industrial property rights or any rights of any other kind, nor does it confer any patent licenses. Mitsubishi Electric Corporation cannot be held responsible for any problems involving industrial property rights which may occur as a result of using the contents noted in this manual.

Warranty
 Mitsubishi will not be held liable for damage caused by factors found not to be the cause of Mitsubishi; opportunity loss or lost profits caused by faults in the Mitsubishi products; damage, secondary damage, accident compensation caused by special factors unpredictable by Mitsubishi; damages to products other than Mitsubishi products; and to other duties.

For safe use

- This product has been manufactured as a general-purpose part for general industries, and has not been designed or manufactured to be incorporated in a device or system used in purposes related to human life.
- Before using the product for special purposes such as nuclear power, electric power, aerospace, medicine or passenger movement vehicles, consult with Mitsubishi Electric.
- This product has been manufactured under strict quality control. However when installing the product where major accidents or losses could occur if the product fails, install appropriate backup or failsafe functions in the system.