

# mitsubishi

---

# MELSECNET/10

# Network Module

---

User's Manual  
(Hardware)

**AJ71QLP21,AJ71QLP21S**  
**AJ71QLR21,AJ71QBR11**

Thank you for buying the Mitsubishi general-purpose programmable controller MELSEC-QnA Series

Prior to use, please read both this manual and detailed manual thoroughly and familiarize yourself with the product.



MODEL	AQ-NET10-M-U-E
MODEL CODE	13JR12
SH(NA)-080073-D(0707)MEE	

# ● SAFETY PRECAUTIONS ●

(Always read before starting use.)

Before using this product, please read this manual and the relevant manuals introduced in this manual carefully and pay full attention to safety to handle the product correctly.

The instructions given in this manual are concerned with this product. For the safety instructions of the programmable controller system, please read the CPU module user's manual.

In this manual, the safety instructions are ranked as "DANGER" and "CAUTION".



**DANGER**

Indicates that incorrect handling may cause hazardous conditions, resulting in death or severe injury.



**CAUTION**

Indicates that incorrect handling may cause hazardous conditions, resulting in medium or slight personal injury or physical damage.

Note that the CAUTION level may lead to a serious consequence according to the circumstances.

Always follow the instructions of both levels because they are important to personal safety.

Please store this manual in a safe place and make it accessible when required. Always forward it to the end user.

## [INSTALLATION PRECAUTIONS]

### CAUTION

- Use the programmable controller in an environment that meets the general specifications contained in CPU module user's manual. Using this programmable controller in an environment outside the range of the general specifications could result in electric shock, fire, erroneous operation, and damage to or deterioration of the product.
- Fully insert the protection on the bottom of the module into the hole in the base unit and press the module into position.  
Not installing the module correctly could result in malfunction, damage, or drop of some pieces of the product.  
If using the product in a vibratory environment, tighten the module with the screws.  
Always tighten the module fixing screws within the specified torque range. Loose tightening could result in drop of some pieces of the product, short-circuit, and malfunction. Tightening the screws too much could result in drop of some pieces of the product, short-circuit, or malfunction due to the breakage of a screw or the module.
- Completely turn off the externally supplied power used in the system before mounting or removing the module.  
Not doing so could result in damage to the product.

## [INSTALLATION PRECAUTIONS]

### CAUTION

- Do not directly touch the printed circuit board, the conducting parts and electronic parts of the module. It may cause damage or erroneous operation.
- Before handling the module, touch a grounded metal object to discharge the static electricity from the human body. Failure to do so may cause malfunction or failure of the module.

## [WIRING PRECAUTIONS]

### DANGER

- Before installation or wiring, be sure to shut off all phases of the external power supply used by the system and the one for the network (AJ71QLP21S). Failure to do so may cause electric shocks or damage the product.

### CAUTION

- Always connect the FG terminals to the ground using class D (class 3) or higher grounding exclusively designed for programmable controller.
- When connecting cables to the terminal block for external power supply, check the rated voltage and terminal layout of the product for correct wiring. Connecting a cable to power supply of different voltage or incorrect wiring may cause a fire or fault.
- Tighten terminal screws to the specified torque.  
If a terminal screw is not tightened to the specified torque, it the module may fall out, short circuit, or malfunction.  
If a terminal screw is tightened excessively, exceeding the specified torque, the module may fall out, short circuit, or malfunction due to breakage of the screw or the module.
- Solder the coaxial cable connector properly. Incomplete soldering may cause a malfunction.
- Be sure there are no foreign substances such as sawdust or wiring debris inside the module. Such debris could cause fires, damage, or erroneous operation.
- Make sure to place the communication and power cables into a duct or fasten them using a clamp.  
Cables not placed in the duct or not clamped may hang or shift, allowing them to be accidentally pulled, which may cause a module malfunction and cable damage.
- When removing the communication cable or power cables from the module, do not pull the cable. When removing the cable with a connector, hold the connector on the side that is connected to the module. When removing the cable connected to the terminal block, first loosen the screws on the terminal block. Pulling the cable that is still connected to the module may cause malfunction or damage to the module or cable.

## Revisions

\* The manual number is noted at the lower right of the top cover.

Print Date	*Manual Number	Revision
Dec., 1999	SH(NA)-080073-A	First printing
Oct., 2004	SH(NA)-080073-B	Correction SAFETY PRECAUTIONS, About the Manuals, Chapter 2, 3, 4, 5, Section 5.1, 5.2.1, 5.2.2, 5.2.3, 6.1, 6.2
May, 2006	SH(NA)-080073-C	Correction SAFETY PRECAUTIONS, Compliance with the EMC Directive and the Low Voltage Directive, Chapter 1, 2, 3, 4, 5, 6
Jul., 2007	SH(NA)-080073-D	Correction Chapter 4, Section 5.1, 5.2.1, 5.2.2, 6.1, 6.3

Japanese Manual Version IB-0800099-D

This manual confers no industrial property rights or any rights of any other kind, nor does it confer any patent licenses. Mitsubishi electric Corporation cannot be held responsible for any problems involving industrial property rights which may occur as a result of using the contents noted in this manual.

© 1999 MITSUBISHI ELECTRIC CORPORATION

# CONTENTS

1. Overview .....	1
2. Performance Specifications .....	2
3. Handling.....	6
3.1 Cable length restrictions between stations .....	6
4. The Name and Setting of Each Part.....	7
5. Wiring.....	12
5.1 Precautions for Laying Optical Fiber Cables .....	13
5.2 Precautions when Installing the Coaxial Cables.....	14
5.2.1 For the Coaxial Loop Type .....	14
5.2.2 For the Coaxial Bus Type.....	15
5.2.3 Connecting the Connector for the Coaxial Cables.....	18
6. External Dimensions .....	20
6.1 AJ71QLP21, AJ71QLP21S .....	20
6.2 AJ71QLR21 .....	21
6.3 AJ71QBR11 .....	22

## About the Manuals

The following product manuals are available. Please use this table as a reference to request the appropriate manual as necessary.

### Detailed Manual

Manual name	Manual No. (Model code)
For QnA/Q4AR MELSECNET/10 Network System Reference Manual	IB-66690 (13JF78)

Before use of this module, be sure to read the For QnA/Q4AR MELSECNET/10 Network System Reference Manual.

## Compliance with the EMC Directive and the Low Voltage Directive

When incorporating the Mitsubishi programmable controller into other industrial machinery or equipment and keeping compliance with the EMC and low voltage directives, refer to Chapter 3 "EMC Directive and Low Voltage Instruction" of the User's Manual (Hardware) for the CPU module used or the programmable controller CPU supplied with the base unit.

The CE logo is printed on the rating plate of the programmable controller, indicating compliance with the EMC and low voltage directives.

For making this product compliant with the EMC and low voltage directives, please refer to Section 3.1.3 "Cable" in Chapter 3 of the above-mentioned user's manual.

# 1. Overview

This manual explains the specifications and names of each part, etc., of the AJ71QLP21(S), AJ71QLR21 and AJ71QBR11 model MELSECNET/10 network module (abbreviated as Network Modules) which are used with MELSECNET/10 network system of the MELSEC-QnA series.

(1) The use, cable used and installation position of the Network Modules are indicated on the following chart.

	Application	Cable used		Position
		Optical fiber cable	Coaxial cable	
AJ71QLP21	The control station, normal station and remote master station of MELSECNET/10	○	—	Main base, Extension base I/O slot
AJ71QLP21S				
AJ71QLR21		—	○	
AJ71QBR11				

(2) After unpacking the Network Modules, confirm that any of the following products is enclosed.

Model	Description	Quantity
AJ71QLP21	Model AJ71QLP21 MELSECNET/10 network module (optical loop type)	1
AJ71QLP21S	Model AJ71QLP21S MELSECNET/10 network module (optical loop type, with external power supply function)	1
AJ71QLR21	Model AJ71QLR21 MELSECNET/10 network module (coaxial loop type)	1
AJ71QBR11	Model AJ71QBR11 MELSECNET/10 network module (coaxial bus type)	1
	F-type connector (A6RCON-F)	1

(3) The coaxial bus-type network system requires terminal resistors (A6RCON-R75: 75Ω) at both terminal stations of the network. The user should arrange for terminal resistors, since the AJ71QBR11 does not come with terminal resistors.

## 2. Performance Specifications

The performance specifications for Network Modules are indicated as follows.

### (1) AJ71QLP21, AJ71QLP21S

Item		Specifications	
		AJ71QLP21	AJ71QLP21S
Maximum link points per network	X/Y	8192 points	
	B	8192 points	
	W	8192 points	
Maximum link points per station	PLC to PLC network	$\left\{ \frac{Y+B}{8} + (2 \times W) \right\} \leq 2000$ bytes	
	Remote I/O network	<ul style="list-style-type: none"> <li>• Remote master station → remote I/O station <math>\left\{ \frac{Y+B}{8} + (2 \times W) \right\} \leq 1600</math> bytes</li> <li>• Remote I/O station → remote master station <math>\left\{ \frac{X+B}{8} + (2 \times W) \right\} \leq 1600</math> bytes</li> <li>• Remote master station → remote sub master station Remote sub master station → remote master station <math>\left\{ \frac{Y+B}{8} + (2 \times W) \right\} \leq 2000</math> bytes</li> </ul>	
Communication speed		10Mbps (equivalent to 20Mbps for multiple transmission)	
Communication method		Token ring	
Synchronization method		Frame synchronization	
Encoding method		NRZI encoding (Non Return to Zero Inverted)	
Transmission route format		Duplex optical loop	
Transmission format		Conform to HDLC (frame format)	
Maximum number of networks		239 (The sum total of PLC to PLC network and remote I/O network)	
Maximum number of groups		9 (Only for PLC to PLC network)	
Number of stations for connection per network	PLC to PLC network	64 stations (Control station: 1 Normal stations: 63)	
	Remote I/O network	65 stations (Remote master station: 1 Remote I/O stations: 64)	
Overall distance		30km	
Station-to-station distance *1	SI optical cable	: 500m	
	H-PCF optical cable	: 1km	
	Broad-band H-PCF optical cable	: 1km	
	QSI optical cable	: 1km	
Error control method		Retry by CRC ( $X^{16}+X^{12}+X^5+1$ ) and overtime	

Item	Specifications		
	AJ71QLP21	AJ71QLP21S	
RAS function	<ul style="list-style-type: none"> <li>• Loop back function due to abnormality detection and cable disconnection</li> <li>• Diagnostic function for local link circuit check</li> <li>• Prevention of system down due to shifting to control station (Only for PLC to PLC networks)</li> <li>• Abnormality detection by link special relay, resistor</li> <li>• Network monitor, each type of diagnostic function</li> <li>• Transient transmission possible even when there is programmable controller CPU abnormality (cause of abnormality can be verified from other station)</li> <li>• Prevention of loopback due to supplying external power (AJ71QLP21S)</li> </ul>		
Transient transmission	N: N communication (Monitor, program upload/download, etc.)		
Connection cable	Optical fiber cable (Arranged by user *2)		
Applicable connector	2-core optical connector plug (Arranged by user *2)		
5VDC current consumption	0.65 A	0.65A	
External supply power (AJ71QLP21S only)	—	Voltage	20.4 to 31.2VDC
		Current	0.20A
		Applicable wire size	0.75 to 2 mm <sup>2</sup>
		Tightening torque	41.1 N•cm
Weight	0.31 kg *3	0.39 kg *4	
No. of occupied I/O points	32 points (I/O assignment: 32 points as special)	48 points (I/O assignment: first 16 points as empty, last 32 points as special) *5	

\*1: There are restrictions to the distance between stations, being determined according to the type of cable and number of stations. See sections 5.1.

\*2: Specialised training and specific tools are required to connect the connector to the optical fiber cable; the connector itself is a custom product. Please contact your nearest Mitsubishi Electric System Service Corporation when purchasing these items.

\*3: The weight for the hardware version M or earlier is 0.45kg.

\*4: The weight for the hardware version P or earlier is 0.55kg.

\*5: Two slots are occupied.

Set the numeric value resulted from adding 10H to the I/O No. of the slot where a module mounted as the "Starting I/O No." of the "Network parameter". The first empty 16 points can be set to "0" on the "I/O assignment" tab screen within the "QnA Parameter" screen.

Example: Set 10H as the "Starting I/O No." when the module is mounted on slot 0. (Set 0H as the "Starting I/O No." when 0 has been set to slot 0 on the "I/O assignment" tab screen.)

For general specifications of the network module, refer to the user's manual for the programmable controller CPU that is to be used.



## (2) AJ71QLR21, AJ71QBR11

Item		Specifications			
		AJ71QLR21		AJ71QBR11	
Maximum link points per network	X/Y	8192 points			
	B	8192 points			
	W	8192 points			
Maximum link points per station	PLC to PLC network	$\left\{ \frac{Y+B}{8} + (2 \times W) \right\} \leq 2000$ bytes			
	Remote I/O network	<ul style="list-style-type: none"> <li>Remote master station → remote I/O station <math>\left\{ \frac{Y+B}{8} + (2 \times W) \right\} \leq 1600</math> bytes</li> <li>Remote I/O station → remote master station <math>\left\{ \frac{X+B}{8} + (2 \times W) \right\} \leq 1600</math> bytes</li> <li>Remote master station → remote sub master station Remote sub master station → remote master station <math>\left\{ \frac{Y+B}{8} + (2 \times W) \right\} \leq 2000</math> bytes</li> </ul>			
Communication speed		10Mbps (equivalent to 20Mbps for multiple transmission)		10Mbps	
Communication method		Token ring		Token bus	
Synchronization method		Frame synchronization			
Encoding method		Manchester encoding			
Transmission route format		Duplex coaxial loop		Single coaxial bus	
Transmission format		Conform to HDLC (frame format)			
Maximum number of networks		239 (The sum total of PLC to PLC network and remote I/O network)			
Maximum number of groups		9 (Only for PLC to PLC network)			
Number of stations for connection per network	PLC to PLC network	64 stations (Control station: 1 Normal stations: 63)		32 stations (Control station: 1 Normal stations: 31)	
	Remote I/O network	65 stations (Remote master station: 1 Remote I/O stations: 64)		33 stations (Remote master station: 1 Remote I/O stations: 32)	
Overall distance (Station-to-station distance) *1		3C-2V	19.2km (300m)	3C-2V	300m (300m)
		5C-2V	30km (500m)	5C-2V	500m (500m)
		—		Can be extended to 2.5km when used with a repeater module (A6BR10, A6BR10-DC)	
Error control method		Retry by CRC ( $X^{16}+X^{12}+X^5+1$ ) and overtime			

Item	Specifications	
	AJ71QLP21	AJ71QLP21S
RAS function	<ul style="list-style-type: none"> <li>• Loop back function due to abnormality detection and cable disconnection (AJ71QLR21)</li> <li>• Diagnostic function for local link circuit check</li> <li>• Prevention of system down due to shifting to control station (Only for PLC to PLC networks)</li> <li>• Abnormality detection by link special relay, resistor</li> <li>• Network monitor, each type of diagnostic function</li> <li>• Transient transmission possible even when there is programmable controller CPU abnormality (cause of abnormality can be verified from other station)</li> </ul>	
Transient transmission	N: N communication (Monitor, program upload/download, etc.)	
Connection cable	Equivalent to 3C-2V, 5C-2V cables (Arranged by user)	
Applicable connector	Equivalent to BNC-P-3-NiCAu (For 3C-2V), BNC-P-5-NiCAu (For 5C-2V) (DDK) (Arranged by user)	
5VDC current consumption	1.14 A	0.80 A
Weight	0.38 kg	0.45 kg
No. of occupied I/O points	32 points (I/O assignment: 32 points as special)	

\*1: There are restrictions to the distance between stations, being determined according to the type of cable and number of stations. See sections 5.2.1 and 5.2.2.

For general specifications of the network module, refer to the user's manual for the programmable controller CPU that is to be used.

## 3. Handling

### [INSTALLATION PRECAUTIONS]

#### CAUTION

- Use the programmable controller in an environment that meets the general specifications contained in CPU module user's manual. Using this programmable controller in an environment outside the range of the general specifications could result in electric shock, fire, erroneous operation, and damage to or deterioration of the product.
- Fully insert the protection on the bottom of the module into the hole in the base unit and press the module into position.  
Not installing the module correctly could result in malfunction, damage, or drop of some pieces of the product.  
If using the product in a vibratory environment, tighten the module with the screws.  
Always tighten the module fixing screws within the specified torque range. Loose tightening could result in drop of some pieces of the product, short-circuit, and malfunction.  
Tightening the screws too much could result in drop of some pieces of the product, short-circuit, or malfunction due to the breakage of a screw or the module.
- Completely turn off the externally supplied power used in the system before mounting or removing the module.  
Not doing so could result in damage to the product.
- Do not directly touch the printed circuit board, the conducting parts and electronic parts of the module. It may cause damage or erroneous operation.
- Before handling the module, touch a grounded metal object to discharge the static electricity from the human body. Failure to do so may cause malfunction or failure of the module.

#### 3.1 Cable length restrictions between stations

- (1) The main modules case is made of plastic, so do not drop it or subject it to strong impacts.
- (2) Do not dismount the printed wiring board from the case. It may damage the module.
- (3) When wiring, be careful never to let foreign matter from the above module such as wiring scraps get inside the module. If something goes in, get rid of it.
- (4) The module installation screw should be kept within the following range.

Screw Locations	Tightening Torque Range
Module installation screws (M4 screws)	78 to 118 N•cm

# 4. The Name and Setting of Each Part

Indicates the name and setting of each part of Network Modules.

AJ71QLP21

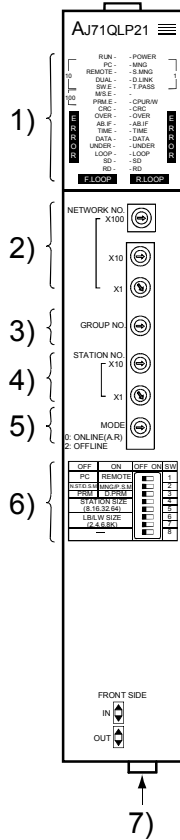

AJ71QLP21S

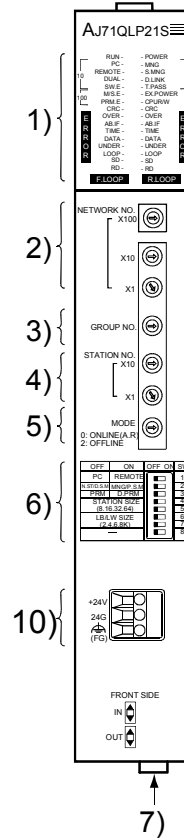

AJ71QLR21

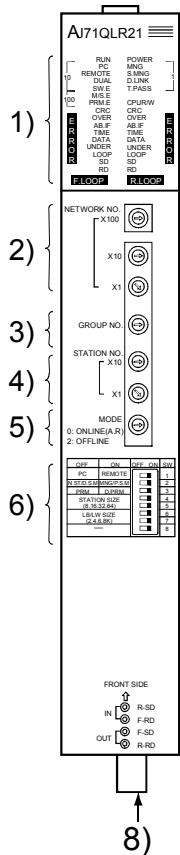

AJ71QBR11

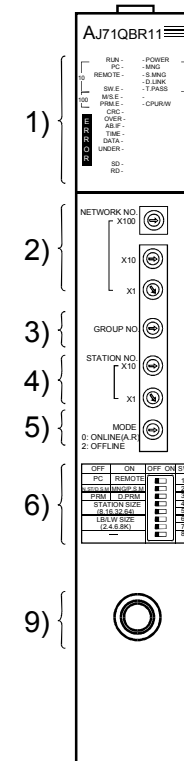

No.	Name	Contents		
		Name	Status	Contents
1)		RUN	ON	Normally operating.
			OFF	WDT error occurred (hardware failure)
		PC	ON	Set as PLC to PLC network (SW1 turned OFF)
		REMOTE		Set as remote I/O network (SW1 turned ON)
		DUAL		Multiplex transfer in execution (OFF: Multiplex transfer not executed)
		SW.E.		Incorrect setting of switches 2) to 6)
		M/S.E.		Station number or control/remote master station status is duplicated on the same network.
		PRM.E.		<ul style="list-style-type: none"> <li>• Duplication of network refreshes parameters when multiple modules are mounted.</li> <li>• Inconsistency between the common and station specific parameters</li> <li>• Difference between parameter received from sub-control station and the one of the host (received from control station).</li> </ul>
		POWER		Power being supplied (OFF: No power being supplied)
		MNG		Operating as control station or remote master station
		S.MNG		Operating as sub-control station or remote sub-master station
		D.LINK		Data link being performed (OFF: Data link stopped)
		T.PASS		Participating in token passing (Transient transmission is available.)
		EX.POWER		Network power (5V) being supplied from external power supply (24V) to 10). *1
		CPU R/W		Communicating with CPU
		CRC		Error detected in code check of receive data <Cause> Timing at which station sending data to target station is disconnected from network, hardware failure, cable fault, noise, etc.
		OVER		Error occurred when receive data processing is delayed <Cause> Hardware failure, cable fault, noise, etc.
		AB.IF		<ul style="list-style-type: none"> <li>• Consecutive 1s exceeding the specified number were received.</li> <li>• Length of received data is too short.</li> </ul> <Cause> Timing at which station sending data to target station is disconnected from network, too short monitoring time, cable fault, noise, etc.
		TIME		Token has not reached host within monitoring time. <Cause> Monitoring time too short, cable fault, noise, etc.
		DATA		Data with erroneous code was received. <Cause> Cable fault, noise, etc.
UNDER	Internal send data processing is not done at fixed intervals. <Cause> Hardware failure			
LOOP	Forward/reverse loop (F.LOOP/R.LOOP) is faulty. <Cause> Power-off of adjacent station, cable disconnection, no connection, etc.			
SD	Dimly	Data being sent		
RD	ON	Data being received		

\*1: This LED lights up with network power that is generated by the external power supply (24V). Therefore, care should be taken since the external power may be supplied even while the LED is off.

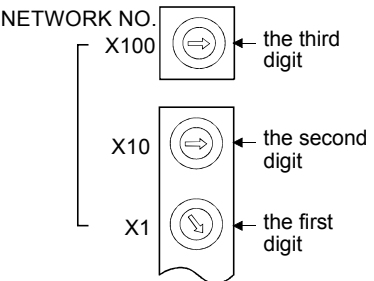
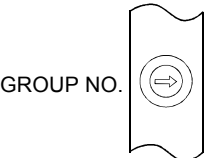
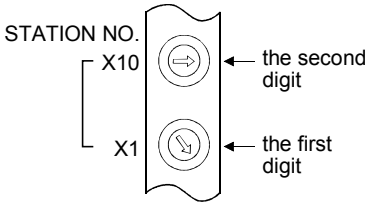
No.	Name	Contents											
2) *2	<b>Network number setting switch</b> 	Network number setting (factory setting at time of shipping: 1) <Setting range> 1 to 239 : Network number Other than 1 to 239: Setting error (The SW.E. LED turns ON) Becomes off-line condition											
3) *2	<b>Group number setting Switch</b> 	Group number setting (factory setting at time of shipping: 0) <Setting range> 0 : No specified group 1 to 9 : Group number ] Enabled for PLC to PLC network											
4) *2	<b>Station number setting switch</b> 	<table border="1"> <thead> <tr> <th colspan="2">Station number setting (factory setting at time of shipping: 1) *3</th> </tr> <tr> <th>Type</th> <th>Setting</th> </tr> </thead> <tbody> <tr> <td rowspan="2">PLC to PLC network</td> <td>1 to 64 : Station number</td> </tr> <tr> <td>Other than 1 to 64: Setting error (The SW.E. LED turns ON)</td> </tr> <tr> <td rowspan="3">Remote I/O network</td> <td>0 : Remote master station</td> </tr> <tr> <td>1 to 64 : Remote sub-master station</td> </tr> <tr> <td>Other than 0 to 64: Setting error (The SW.E. LED turns ON)</td> </tr> </tbody> </table>	Station number setting (factory setting at time of shipping: 1) *3		Type	Setting	PLC to PLC network	1 to 64 : Station number	Other than 1 to 64: Setting error (The SW.E. LED turns ON)	Remote I/O network	0 : Remote master station	1 to 64 : Remote sub-master station	Other than 0 to 64: Setting error (The SW.E. LED turns ON)
Station number setting (factory setting at time of shipping: 1) *3													
Type	Setting												
PLC to PLC network	1 to 64 : Station number												
	Other than 1 to 64: Setting error (The SW.E. LED turns ON)												
Remote I/O network	0 : Remote master station												
	1 to 64 : Remote sub-master station												
	Other than 0 to 64: Setting error (The SW.E. LED turns ON)												

\*2: When the setting has been changed with the programmable controller CPU powered ON, reset the programmable controller CPU (Shift the RUN/STOP key switch from RESET to any other than RESET.)

\*3: The setting range for the AJ71QBR11 is shown below.

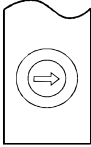

Type	Setting
PLC to PLC network	1 to 32 : Station number
	Other than 1 to 32: Setting error (The SW.E. LED turns ON. Note that it does not turn ON when set to any of 33 to 64.)
Remote I/O network	0 : Remote master station
	1 to 32 : Remote sub-master station
	Other than 0 to 32: Setting error (The SW.E. LED turns ON. Note that it does not turn ON when set to any of 33 to 64.)

No.	Name	Contents																																													
5) *4	Mode setting switch  MODE 0: ONLINE(A.R) 2: OFFLINE 	Mode setting (factory setting at time of shipping: 0)																																													
		Mode	Name	Contents																																											
		0	Online (automatic online return effective)	Data link with automatic online return effective																																											
		1	Not used (Setting to this turns on the SW.E. LED.)																																												
		2	Offline	Disconnects the host station.																																											
		3	Forward loop test	Checks the forward loop of the whole network system.																																											
		4	Reverse loop test	Checks the reverse loop of the whole network system.																																											
		5	Station-to-station test (master station)	The mode for a line check between two stations, in which the station with the smaller number is regarded as the master station and the other is considered the slave station.																																											
		6	Station-to-station test (slave station)																																												
		7	Self-loopback test	Check the hardware of a module in isolation, including the communication circuit and cables of the transmission system.																																											
		8	Internal self-loopback test	Check the hardware of a module in isolation, including the communication circuit of the transmission system.																																											
		9	Hardware test	Check the hardware inside the network module.																																											
		A to C	Not used	(Do not set the mode.)																																											
		D	Test mode 8	Network No. check (LED display)																																											
E	Test mode 9	Group No. check (LED display)																																													
F	Test mode 10	Station No. check (LED display)																																													
6) *4	Conditions setting switch  <table border="1" style="display: inline-table; vertical-align: middle;"> <tr> <td>OFF</td> <td>ON</td> <td>OFF</td> <td>ON</td> <td>SW</td> </tr> <tr> <td>PC</td> <td>REMOTE</td> <td><input type="checkbox"/></td> <td><input type="checkbox"/></td> <td>1</td> </tr> <tr> <td>N.ST/D.S.M</td> <td>MNG/P.S.M</td> <td><input type="checkbox"/></td> <td><input type="checkbox"/></td> <td>2</td> </tr> <tr> <td>PRM</td> <td>D.PRM</td> <td><input type="checkbox"/></td> <td><input type="checkbox"/></td> <td>3</td> </tr> <tr> <td colspan="2">STATION SIZE (8.16.32.64)</td> <td><input type="checkbox"/></td> <td><input type="checkbox"/></td> <td>4</td> </tr> <tr> <td colspan="2">LB/LW SIZE (2.4.6.8K)</td> <td><input type="checkbox"/></td> <td><input type="checkbox"/></td> <td>5</td> </tr> <tr> <td colspan="2">—</td> <td><input type="checkbox"/></td> <td><input type="checkbox"/></td> <td>6</td> </tr> <tr> <td colspan="2">—</td> <td><input type="checkbox"/></td> <td><input type="checkbox"/></td> <td>7</td> </tr> <tr> <td colspan="2">—</td> <td><input type="checkbox"/></td> <td><input type="checkbox"/></td> <td>8</td> </tr> </table>	OFF	ON	OFF	ON	SW	PC	REMOTE	<input type="checkbox"/>	<input type="checkbox"/>	1	N.ST/D.S.M	MNG/P.S.M	<input type="checkbox"/>	<input type="checkbox"/>	2	PRM	D.PRM	<input type="checkbox"/>	<input type="checkbox"/>	3	STATION SIZE (8.16.32.64)		<input type="checkbox"/>	<input type="checkbox"/>	4	LB/LW SIZE (2.4.6.8K)		<input type="checkbox"/>	<input type="checkbox"/>	5	—		<input type="checkbox"/>	<input type="checkbox"/>	6	—		<input type="checkbox"/>	<input type="checkbox"/>	7	—		<input type="checkbox"/>	<input type="checkbox"/>	8	Operation condition setting (factory setting at the time of shipping: all off)
		OFF	ON	OFF	ON	SW																																									
		PC	REMOTE	<input type="checkbox"/>	<input type="checkbox"/>	1																																									
		N.ST/D.S.M	MNG/P.S.M	<input type="checkbox"/>	<input type="checkbox"/>	2																																									
		PRM	D.PRM	<input type="checkbox"/>	<input type="checkbox"/>	3																																									
		STATION SIZE (8.16.32.64)		<input type="checkbox"/>	<input type="checkbox"/>	4																																									
		LB/LW SIZE (2.4.6.8K)		<input type="checkbox"/>	<input type="checkbox"/>	5																																									
		—		<input type="checkbox"/>	<input type="checkbox"/>	6																																									
		—		<input type="checkbox"/>	<input type="checkbox"/>	7																																									
		—		<input type="checkbox"/>	<input type="checkbox"/>	8																																									
SW	Contents	OFF	ON																																												
1	Network type	PLC to PLC network	Remote I/O network																																												
2	Station type	Normal station/Multiple sub master station *5	Control station/parallel sub masters station *5																																												
3	Use parameters	Parameters in common	Default Parameters																																												
4	Number of stations	OFF	8 stations	ON	16 stations	OFF	32 stations	ON	64 stations																																						
		OFF	8 stations	OFF	16 stations	ON	32 stations	ON	64 stations																																						
5	[ Valid when SW3 is ON ]	OFF	2k points	ON	4k points	OFF	6k points	ON	8k points																																						
		OFF	2k points	OFF	4k points	ON	6k points	ON	8k points																																						
6	B/W number of general point	OFF	2k points	ON	4k points	OFF	6k points	ON	8k points																																						
7	[ Valid when SW3 is ON ]	OFF	2k points	OFF	4k points	ON	6k points	ON	8k points																																						
8	Not used (always off)																																														

\*4: When the setting has been changed with the programmable controller CPU powered ON, reset the programmable controller CPU (Shift the RUN/STOP key switch from RESET to any other than RESET.)  
 Note that resetting the programmable controller CPU is not needed for mode "D" to "F".

\*5: For use in the remote I/O network, it is enabled when the station number is any of 1 to 64.

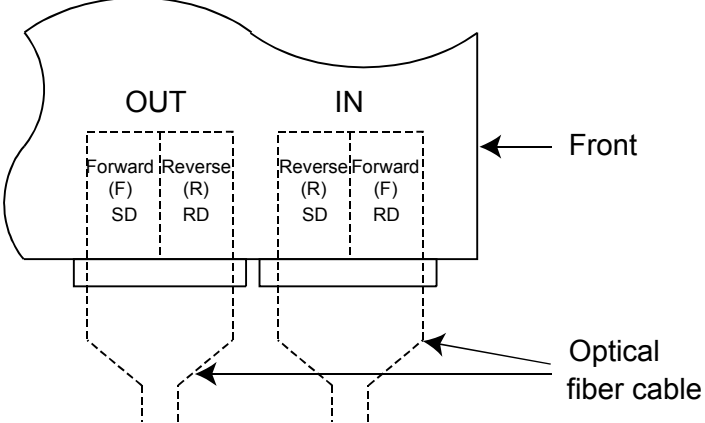
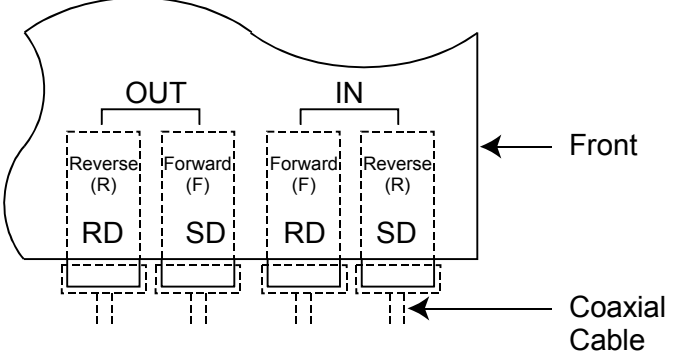
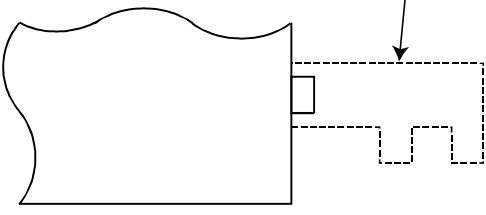
\*6: The settings are enabled when the module is a control station in the PLC to PLC network.

No.	Name	Contents
7)	Connector (AJ71QLP21(S))	<p>Connect the optical fiber cable.</p> 
8)	Connector (AJ71QLR21)	<p>Connect the coaxial type cable.</p> 
9)	Connector (AJ71QBR11)	<p>Connect the F-type connector.</p> 
10)	External power source supply terminal (AJ71QLP21S)	<p>When preventing loop pack by turning OFF the power source of the programmable controller CPU, supply an external power source.</p> 



## 5. Wiring

### **DANGER**

- Before installation or wiring, be sure to shut off all phases of the external power supply used by the system and the one for the network (AJ71QLP21S). Failure to do so may cause electric shocks or damage the product.

### **CAUTION**

- Always connect the FG terminals to the ground using class D (class 3) or higher grounding exclusively designed for programmable controller.
- When connecting cables to the terminal block for external power supply, check the rated voltage and terminal layout of the product for correct wiring. Connecting a cable to power supply of different voltage or incorrect wiring may cause a fire or fault.
- Tighten terminal screws to the specified torque.  
If a terminal screw is not tightened to the specified torque, it the module may fall out, short circuit, or malfunction.  
If a terminal screw is tightened excessively, exceeding the specified torque, the module may fall out, short circuit, or malfunction due to breakage of the screw or the module.
- Solder the coaxial cable connector properly. Incomplete soldering may cause a malfunction.
- Be sure there are no foreign substances such as sawdust or wiring debris inside the module. Such debris could cause fires, damage, or erroneous operation.
- Make sure to place the communication and power cables into a duct or fasten them using a clamp.  
Cables not placed in the duct or not clamped may hang or shift, allowing them to be accidentally pulled, which may cause a module malfunction and cable damage.
- When removing the communication cable or power cables from the module, do not pull the cable. When removing the cable with a connector, hold the connector on the side that is connected to the module. When removing the cable connected to the terminal block, first loosen the screws on the terminal block. Pulling the cable that is still connected to the module may cause malfunction or damage to the module or cable.

## 5.1 Precautions for Laying Optical Fiber Cables

- (1) The optical fiber cable type that can be used differs depending on the station to station distance.

Type	Distance between stations
SI optical fiber cable	500 m (1640.5 ft.)
H-PCF optical fiber cable	1000 m (3281 ft.)
Broad-band H-PCF optical fiber cable	1000 m (3281 ft.)
QSI optical fiber cable	1000 m (3281 ft.)

- (2) When connecting an optical fiber cable, the following restrictions on the bending radius must be observed.

Make sure of the specifications of the cable to be used.

- (3) The optical fiber cable is wired in the following manner.

There is no problem even if not wiring in order of the station number.

There is no problem even if station how many become control station.

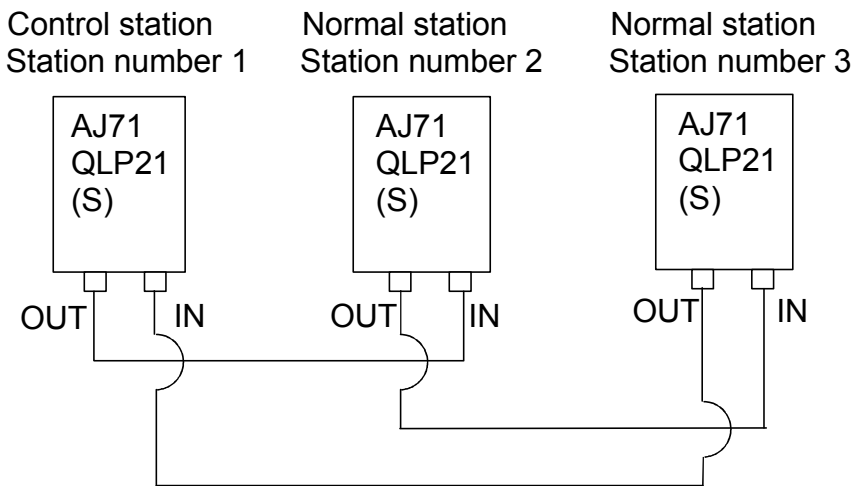

- (4) When laying the optical fiber cable, do not touch the fiber core of the cable connector or module connector, or let dirt or dust collect on it.

If oil from the hands, dirt or dust should adhere to the core, the transmission loss will increase, causing a malfunction in the data link.

Also, do not remove the cover from the module connector until an optical fiber cable is connected.

- (5) When attaching or detaching the optical fiber cable to/from the module, hold the cable connector securely with the hands.

- (6) Connect the cable connector and module connector securely until you hear a "click" sound.

- (7) Please wire IN/OUT of the connector for the cable correctly.

Please do loopback test, the set confirmation test, and the bureau order confirmation test after wiring.

It might be generated that a baton abnormal passing cannot be generated when miswiring and the downed bureau which cannot do the loopback of an arbitrary bureau do the row again even by the reclosing of the power supply.

- (8) Completely turn off the externally supplied power used in the system when connecting or disconnecting the cable.

## 5.2 Precautions when Installing the Coaxial Cables

### 5.2.1 For the Coaxial Loop Type

- (1) For connection between network modules, use the cable length given in the following table depending on the cable type.

Cable type	Interstation cable length	Overall distance
3C-2V	300 m (984.3 ft.)	19.2 km (62995.2ft.)
5C-2V	500 m (1640.5 ft.)	30 km (98430 ft.)

- (2) When connecting a coaxial cable, the following restrictions on the bending radius must be observed.

Cable type	Allowable bending radius r [mm(in.)]	Connector A [mm(in.)]
3C-2V	23 (0.91)	35 (1.38)
5C-2V	30 (1.18)	

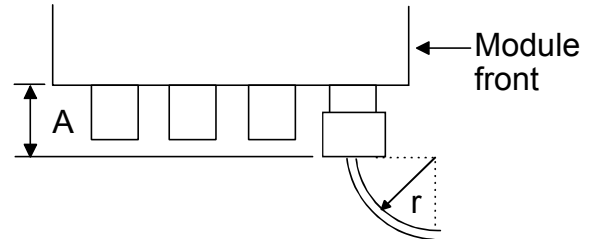

- (3) The Coaxial cable is wired in the following manner.

There is no problem even if not wiring in order of the station number.  
There is no problem even if station how many become control station.

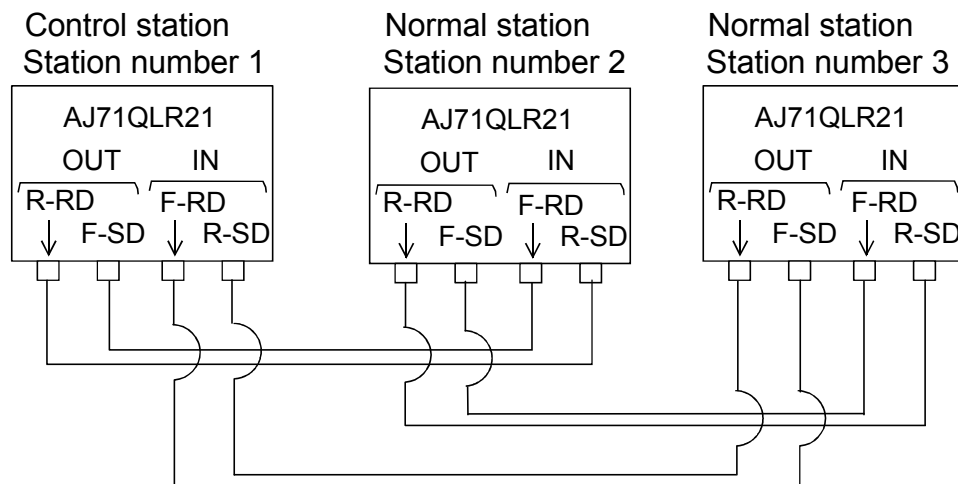

- (4) Install the coaxial cables at least 100 mm (3.94 in.) away from other power cables and control cables.

- (5) Consider wiring using double-shielded coaxial cable in places that are subject to large amounts of noise.

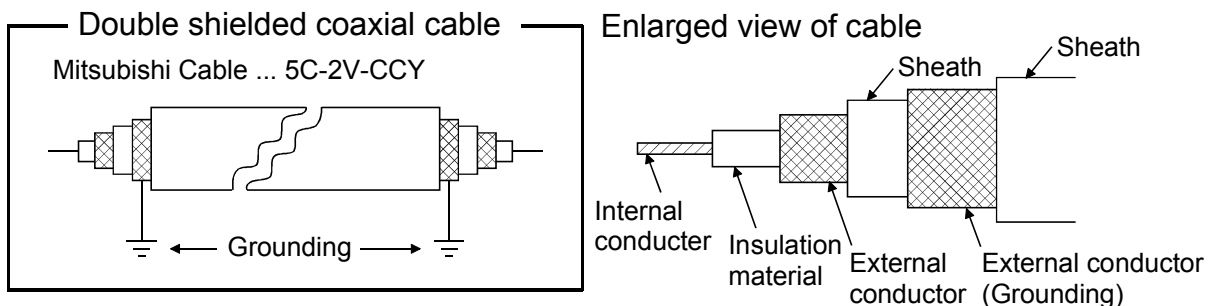

The 5C-2V connector plug is applicable to double-shielded coaxial cable. Connect the 5C-2V connector plug to the coaxial cable inside a double-shielded coaxial cable. Ground the shielded part outside a double-shielded coaxial cable as shown in the above figure.

- (6) Do not pull any of the connected cables.  
This will cause a faulty contact, cable disconnection, or damage to the module.
- (7) Please wire SD/RD of the connector for the cable correctly.  
Please do loopback test, the set confirmation test, and the bureau order confirmation test after wiring.  
It might be generated that a baton abnormal passing cannot be generated when miswiring and the downed bureau which cannot do the loop back of an arbitrary bureau do the row again even by the reclosing of the power supply.
- (8) Completely turn off the externally supplied power used in the system when connecting or disconnecting the cable.

### 5.2.2 For the Coaxial Bus Type

- (1) The cable to connect between network modules must be the following according to the number of stations connected.  
When a cable length other than those specified in the table below is used, a communication error may result.

Station-to-station cable length \ Number of stations connected	2 to 9 stations		10 to 33 stations	
	3C - 2V	5C - 2V	3C - 2V	5C - 2V
0 to 1 m (3.28 ft.)	× (cable less than 1m (3.28 ft.) in length cannot be used.)			
1 (3.28 ft.) to 5 m (16.41 ft.)	○	○	○	○
5 (16.41 ft.) to 13 m (42.65 ft.)	○	○	×	×
13 (42.65 ft.) to 17 m (55.78 ft.)	○	○	○	○
17 (55.78 ft.) to 25 m (82.03 ft.)	○	○	×	×
25 (82.03 ft.) to 300 m (984.3 ft.)	○	○	○	○
300 (984.3 ft.) to 500 m (1640.5 ft.)	×	○	×	○

○: Allowed ×: Not allowed

- (2) If there is the possibility of an increase in the number of stations due to system expansion, install the cables with advance consideration of the restrictions.
- (3) When using a repeater module (models A6BR10 or A6BR10-DC), use the station-to-station cable length indicated by "10 to 33" stations, regardless of the number of stations connected or the number of repeater modules.
- (4) When connecting a coaxial cable, the following restrictions on the bending radius must be observed.

Cable type	Allowable bending radius r [mm (in.)]	Connector A [mm (in.)]
3C-2V	23 (0.91)	50 (1.97)
5C-2V	30 (1.18)	

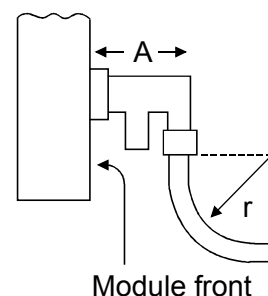

- (5) The coaxial cable is wired in the following manner.  
 There is no program even if not wiring in order of the station number.  
 There is no program even if station how many become control station.

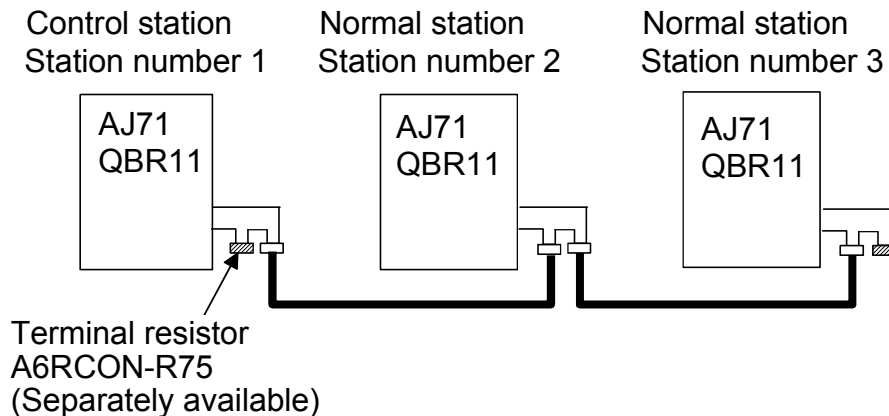

- (6) Install the coaxial cables at least 100 mm (3.94 in.) away from other power cables and control cables.  
 (7) Consider wiring using double-shielded coaxial cable in places that are subject to large amounts of noise.

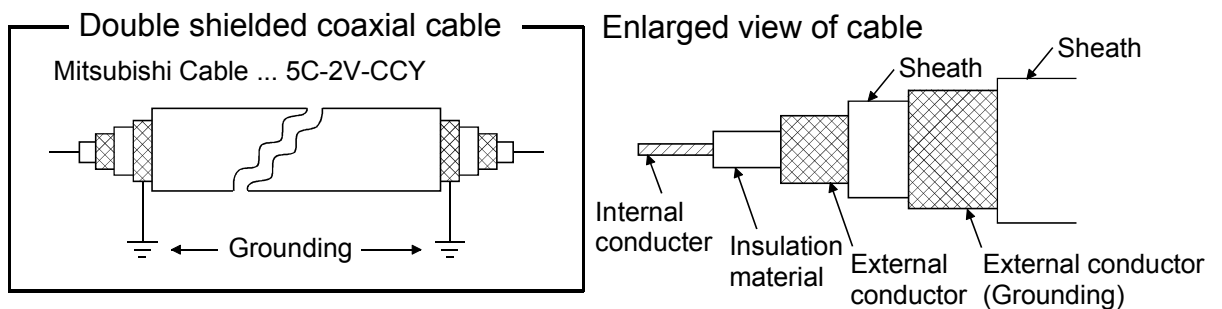

The 5C-2V connector plug is applicable to double-shielded coaxial cable. Connect the 5C-2V connector plug to the coaxial cable inside a double-shielded coaxial cable. Ground the shielded part outside a double-shielded coaxial cable as shown in the above figure.

- (8) Do not pull any of the connected coaxial cables.  
 This will cause a faulty contact, cable disconnection, or damage to the module.  
 (9) Make sure to connect a terminal resistor to both terminal stations of the coaxial bus type network system.  
 (10) A white oxide, which may be deposited on the F-type connector depending on the operating environment, is not produced in the fitting portion, posing no functional problems.  
 (11) Completely turn off the externally supplied power used in the system when connecting or disconnecting the cable.

(12) There are integral type and separate F-type connectors. In the case of the separate F-type connector, tighten the ring of the connector until the ring is tight before connecting the connector to the network module. If the ring is loose, a communication error may occur.

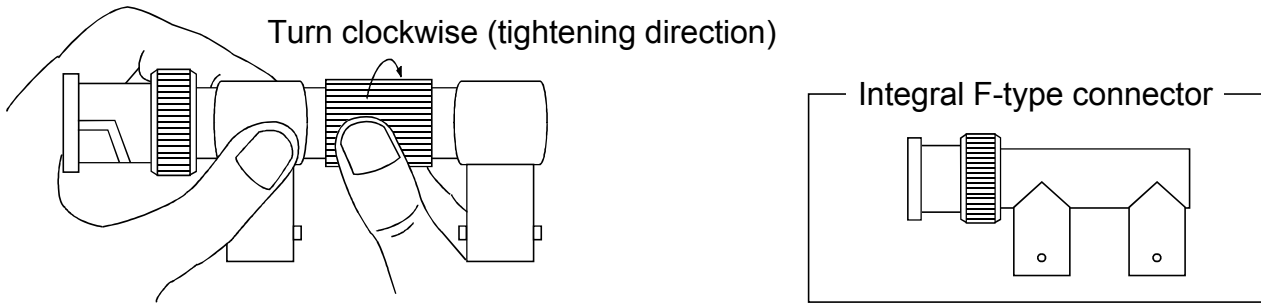

After connecting the F-type connector to the network module, retighten its ring periodically. Retighten it with both hands as shown below.

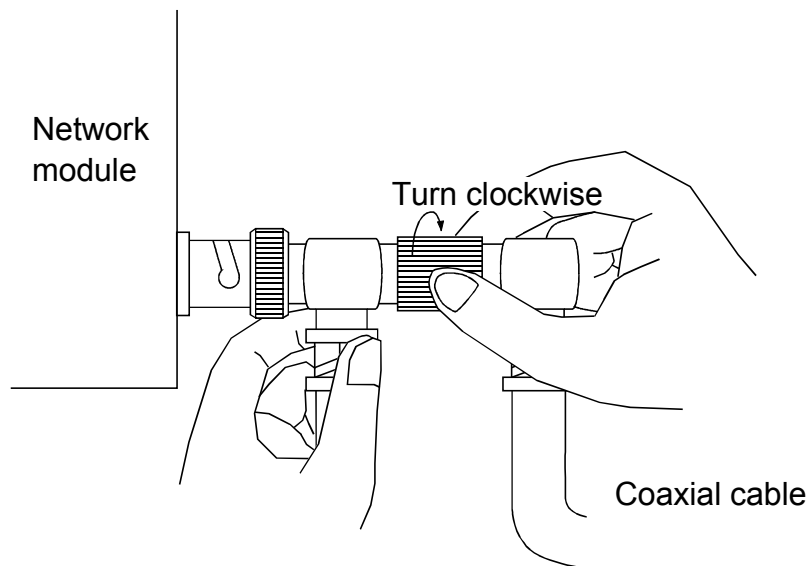

### 5.2.3 Connecting the Connector for the Coaxial Cables

The following section explains how to connect the BNC connector (connector plug for the coaxial cable) to the cable.

#### (1) Structure of the BNC connector and coaxial cable

The structure of the BNC connector and coaxial cable are shown in the figure below.

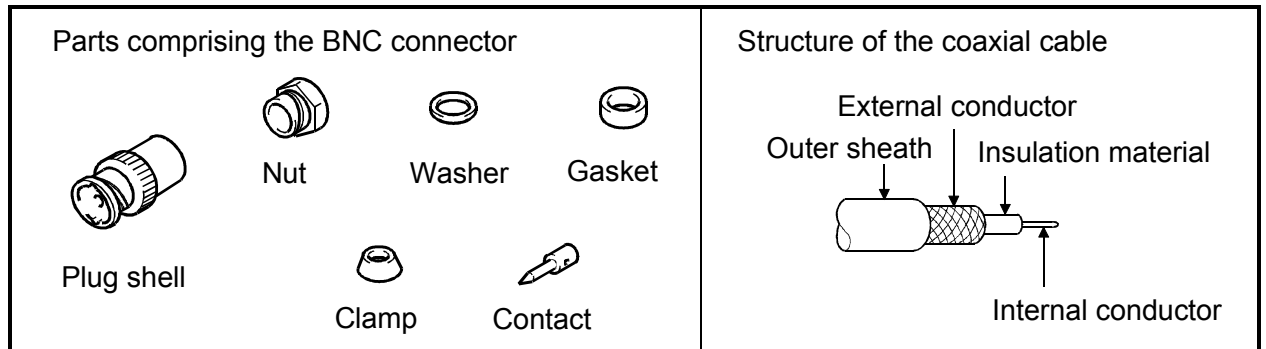

#### (2) How to connect the BNC connector and the coaxial cable

(a) Cut off the outer sheath of the coaxial cable to the length shown in the diagram below.

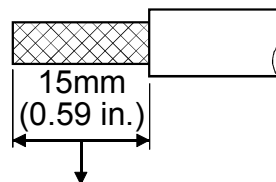

Cut this portion of the outer sheath

(b) Feed the nut, washer, gasket and clamp on the coaxial cable through, as shown below, then unfasten the external conductor.

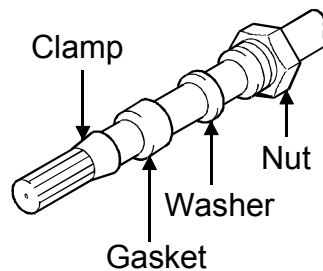

- (c) Cut the external conductor, insulation material and internal conductor to the dimensions shown below. However, cut the external conductor to the same dimension as the tapered section of the clamp and smooth it down to the clamp.

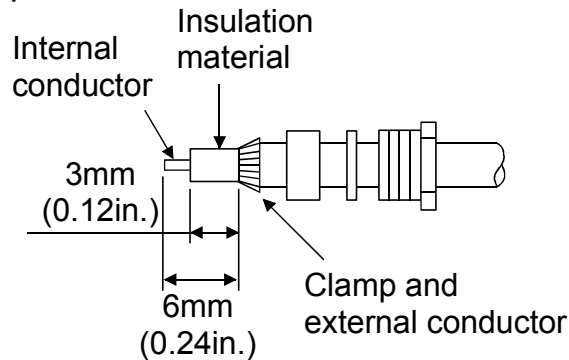

- (d) Solder the contact to the internal conductor.

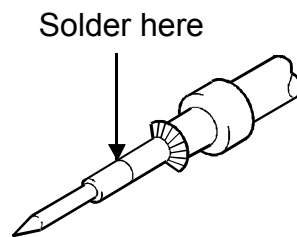

- (e) Insert the connector assembly in (d) into the plug shell and screw the nut into the plug shell.

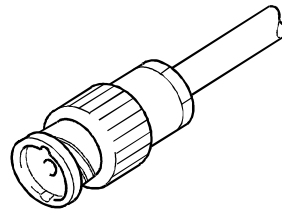

**Important**

- (1) Note the following precautions when soldering the internal conductor and contact.
  - Make sure that the solder does not bead up at the soldered section.
  - Make sure there are no gaps between the connector and cable insulator or they do not cut into each other.
  - Perform soldering quickly so the insulation material does not become deformed.
- (2) Before connecting or disconnecting the coaxial connector, touch a grounded metal object to discharge the static electricity from the human body. Failure to do so may result in a module malfunction.



## 6. External Dimensions

### 6.1 AJ71QLP21, AJ71QLP21S

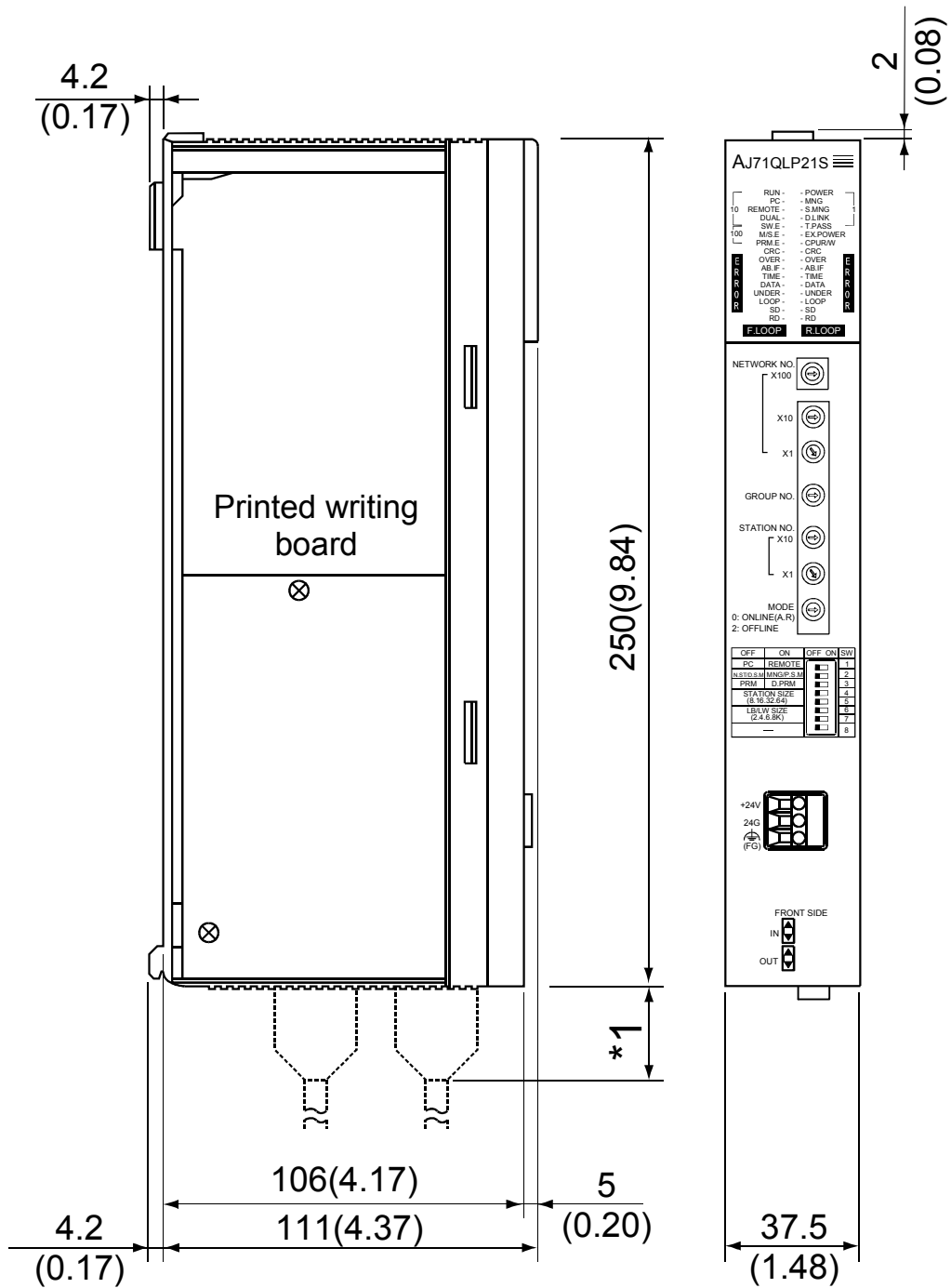

Unit: mm (in.)

\*1: Please confirm details to Mitsubishi Electric System Service Corporation.

# 6.2 AJ71QLR21

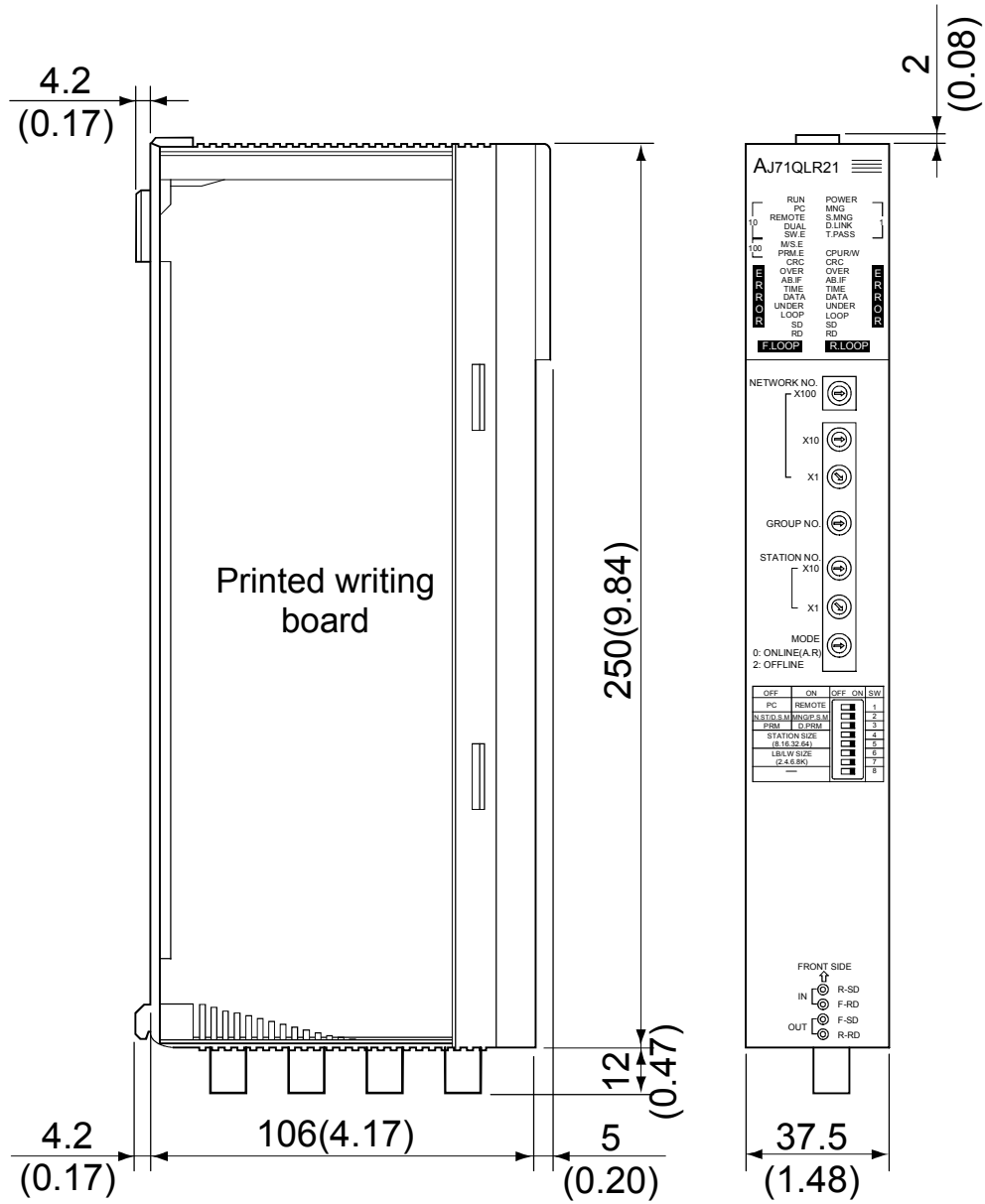

Unit: mm (in.)

### 6.3 AJ71QBR11

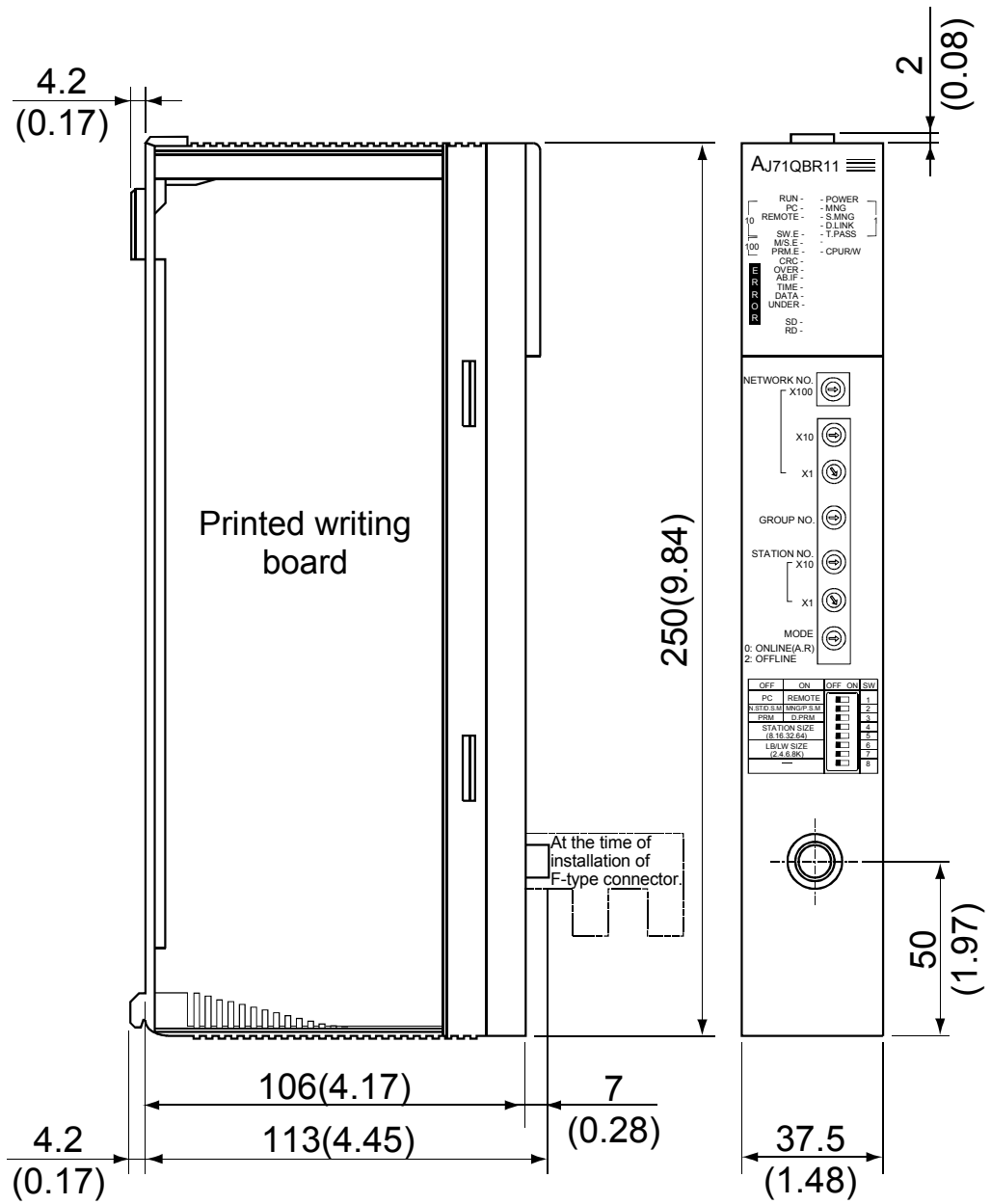

Unit: mm (in.)

## Warranty

Mitsubishi will not be held liable for damage caused by factors found not to be the cause of Mitsubishi; machine damage or lost profits caused by faults in the Mitsubishi products; damage, secondary damage, accident compensation caused by special factors unpredictable by Mitsubishi; damages to products other than Mitsubishi products; and to other duties.

### ⚠ For safe use

- This product has been manufactured as a general-purpose part for general industries, and has not been designed or manufactured to be incorporated in a device or system used in purposes related to human life.
- Before using the product for special purposes such as nuclear power, electric power, aerospace, medicine or passenger movement vehicles, consult with Mitsubishi.
- This product has been manufactured under strict quality control. However, when installing the product where major accidents or losses could occur if the product fails, install appropriate backup or failsafe functions in the system.

Country/Region	Sales office/Tel	Country/Region	Sales office/Tel
U.S.A	Mitsubishi Electric Automation Inc. 500 Corporate Woods Parkway Vernon Hills, IL 60061, U.S.A. Tel : +1-847-478-2100	Hong Kong	Mitsubishi Electric Automation (Hong Kong) Ltd. 10th Floor, Manulife Tower, 169 Electric Road, North Point, Hong Kong Tel : +852-2887-8870
Brazil	MELCO-TEC Rep. Com.e Assessoria Tecnica Ltda. Rua Correia Dias, 184, Edificio Paraiso Trade Center-8 andar Paraiso, Sao Paulo, SP Brazil Tel : +55-11-5908-8331	China	Mitsubishi Electric Automation (Shanghai) Ltd. 4/F Zhi Fu Plazz, No.80 Xin Chang Road, Shanghai 200003, China Tel : +86-21-6120-0808
Germany	Mitsubishi Electric Europe B.V. German Branch Gothaer Strasse 8 D-40880 Ratingen, GERMANY Tel : +49-2102-486-0	Taiwan	Setsuyo Enterprise Co., Ltd. 6F No.105 Wu-Kung 3rd.Rd, Wu-Ku Hsiang, Taipei Hsine, Taiwan Tel : +886-2-2299-2499
U.K	Mitsubishi Electric Europe B.V. UK Branch Travellers Lane, Hatfield, Hertfordshire., AL10 8XB, U.K. Tel : +44-1707-276100	Korea	Mitsubishi Electric Automation Korea Co., Ltd. 1480-6, Gayang-dong, Gangseo-ku Seoul 157-200, Korea Tel : +82-2-3660-9552
Italy	Mitsubishi Electric Europe B.V. Italian Branch Centro Dir. Colleoni, Pal. Perseo-Ingr.2 Via Paracelso 12, I-20041 Agrate Brianza., Milano, Italy Tel : +39-039-60531	Singapore	Mitsubishi Electric Asia Pte, Ltd. 307 Alexandra Road #05-01/02, Mitsubishi Electric Building, Singapore 159943 Tel : +65-6470-2460
Spain	Mitsubishi Electric Europe B.V. Spanish Branch Carretera de Rubi 76-80, E-08190 Sant Cugat del Valles, Barcelona, Spain Tel : +34-93-565-3131	Thailand	Mitsubishi Electric Automation (Thailand) Co., Ltd. Bang-Chan Industrial Estate No.111 Moo 4, Serithai Rd, T.Kannayao, A.Kannayao, Bangkok 10230 Thailand Tel : +66-2-517-1326
France	Mitsubishi Electric Europe B.V. French Branch 25, Boulevard des Bouvets, F-92741 Nanterre Cedex, France TEL: +33-1-5568-5568	Indonesia	P.T. Autoteknindo Sumber Makmur Muara Karang Selatan, Block A/Utara No.1 Kav. No.11 Kawasan Industri Pergudangan Jakarta - Utara 14440, P.O.Box 5045 Jakarta, 11050 Indonesia Tel : +62-21-6630833
South Africa	Circuit Breaker Industries Ltd. Private Bag 2016, ZA-1600 Isando, South Africa Tel : +27-11-928-2000	India	Messung Systems Pvt, Ltd. Electronic Sadan NO:III Unit No15, M.I.D.C Bhosari, Pune-411026, India Tel : +91-20-2712-3130
		Australia	Mitsubishi Electric Australia Pty. Ltd. 348 Victoria Road, Rydalmere, N.S.W 2116, Australia Tel : +61-2-9684-7777

## MITSUBISHI ELECTRIC CORPORATION

HEAD OFFICE : TOKYO BUILDING, 2-7-3 MARUNOUCHI, CHIYODA-KU, TOKYO 100-8310, JAPAN  
NAGOYA WORKS : 1-14, YADA-MINAMI 5-CHOME, HIGASHI-KU, NAGOYA, JAPAN

When exported from Japan, this manual does not require application to the Ministry of Economy, Trade and Industry for service transaction permission.

Specifications subject to change without notice.  
Printed in Japan on recycled paper.