



TRANSISTORIZED INVERTER
INSTRUCTION MANUAL

—
HIGH-DUTY BRAKE RESISTOR
—

FR-ABR-(H)0.4K to 22K

Thank you for choosing the Mitsubishi transistorized inverter option unit.

This instruction manual gives handling information and precautions for use of this equipment.

Incorrect handling might cause an unexpected fault. Before using the equipment, please read this manual carefully to use the equipment to its optimum.

Please forward this instruction manual to the end user.

Safety Instructions

Do not attempt to install, operate, maintain or inspect this product until you have read through this instruction manual and appended documents carefully and can use the equipment correctly.

Do not use this product until you have a full knowledge of the equipment, safety information and instructions.

In this manual, the safety instruction levels are classified into "WARNING" and "CAUTION".



Denotes that incorrect handling may cause hazardous conditions, resulting in death or severe injury.



Denotes that incorrect handling may cause hazardous conditions, resulting in medium or slight injury, or may cause physical damage only.

Note that even the  CAUTION level may lead to a serious consequence under some circumstances. Please follow the instructions of both levels as they are important to personnel safety.

SAFETY INSTRUCTIONS

1. Electric Shock Prevention



WARNING

- Before starting wiring or inspection, switch power off, wait for more than 10 minutes, and check for no residual voltage with a meter etc.
- Any person who is involved in the wiring or inspection of this equipment should be fully competent to do the work.

2. Fire Prevention

CAUTION

- Mount the brake resistor on a nonflammable surface. Installing it directly on or near a flammable surface could cause a fire.
- Use the alarm signal to switch power off. A failure to do so can overheat the brake resistor due to a brake transistor failure etc., causing a fire.

3. Injury Prevention

CAUTION

- Ensure that the cables are connected to the correct terminals. Otherwise, damage, etc. may occur.
- While power is on or for some time after power-off, do not touch the brake resistor as it is hot. Touching it can cause burns.

4. Additional Instructions

Also note the following points to prevent an accidental failure, injury, electric shock, etc.:

(1) Transportation and installation

CAUTION

- Transport products in a correct manner according to their weights. Not doing so can cause injury.
- Install the product in a place secure enough to withstand its weight according to the instruction manual.

(2) Usage

WARNING

- Do not modify the equipment.
- Do not perform parts removal which is not instructed in this manual. Doing so may lead to fault or damage of the inverter.

(3) Disposal

CAUTION

- Dispose of this product as general industrial waste.

(4) General instructions

Many of the diagrams and drawings in this instruction manual show the inverter without a cover, or partially open. Never run the inverter like this. Always replace the cover and follow the instruction manual when operating the inverter.

INSTALLATION INSTRUCTIONS FOR COMPLIANCE WITH UL

Install the high-duty brake resistor FR-ABR as follows:

- The brake resistor may be mounted horizontally or vertically, depending on a suitable surface location.
- When the brake resistor is mounted externally to the enclosure housing the inverter, install a solid Type 1 enclosure at least 8 times the volume size of the brake resistor that incorporates mesh or perforated steel type ventilation openings at each end of the resistor. Note, the vent openings shall not be greater than 10 mm diameter.
- Secure the enclosure to a nonflammable surface only, such as metal or concrete.
- Mount the brake resistor inside the Type 1 enclosure and wire it in accordance with the NEC for North America installations or any other local codes.

Note, when the brake resistor and inverter are mounted together within a suitable enclosure, the mesh covering is not required. Take care that the temperature inside the enclosure does not exceed 50°C.

Since the enclosure surface becomes a high temperature, it presents a possible burn hazard. After installation, the following marking in minimum 3 mm (1/8 in.) sized lettering shall be provided on the enclosure where visible:

CAUTION : HOT SURFACE. TO REDUCE RISK OF BURN - DO NOT TOUCH.

1. UNPACKING AND CHECKING THE MODEL AND APPLICABLE INVERTERS

Take the brake resistor out of the package and confirm that the product is as you ordered and intact.

• Type FR-ABR - 0.4 K
 Indicate capacity (kW)

Symbol	Voltage class
No	200V class
H	400V class

(For the FR-ABR-H15K, a terminal block for connecting resistors is enclosed as two resistors need to be connected in parallel.) FR-ABR-15K is indicated on the resistor. (A type name indicated on the package is different.)

The FR-ABR Series brake resistors are a UL Listed accessory for use only with the following UL listed inverter models:

High-Duty Brake Resistor Model		Applicable Inverter Models
200V Class	FR-ABR-0.4K	FR-A520-0.4K(-**) FR-E520-0.4K(C)(-**), FR-E520S-0.4K(-**), FR-E510W-0.4K(-**) FR-A024-0.4K(-**) FR-S520E-0.4K(-**) FR-A720-0.4K(-**) FR-E720-0.4K(-**)
	FR-ABR-0.75K	FR-A520-0.75K(-**) FR-E520-0.75K(C)(-**), FR-E520S-0.75K(-**), FR-E510W-0.75K(-**) FR-A024-0.75K(-**) FR-S520E-0.75K(-**) FR-A720-0.75K(-**) FR-E720-0.75K(-**)
	FR-ABR-2.2K	FR-A520-1.5K(-**), FR-A520-2.2K(-**) FR-E520-1.5K(C)(-**), FR-E520-2.2K(C)(-**) FR-V520-1.5K(-**), FR-V520-2.2K(-**) FR-A024-1.5K(-**), FR-A024-2.2K(-**) FR-S520E-1.5K(-**), FR-S520E-2.2K(-**) FR-A720-1.5K(-**), FR-A720-2.2K(-**) FR-E720-1.5K(-**), FR-E720-2.2K(-**)
	FR-ABR-3.7K	FR-A520-3.7K(-**) FR-E520-3.7K(C)(-**) FR-V520-3.7K(-**) FR-A024-3.7K(-**) FR-S520E-3.7K(-**) FR-A720-3.7K(-**) FR-E720-3.7K(-**)
	FR-ABR-5.5K	FR-A520-5.5K(-**) FR-E520-5.5K(C)(-**) FR-V520-5.5K(-**) FR-A720-5.5K(-**) FR-E720-5.5K(-**)
	FR-ABR-7.5K	FR-A520-7.5K(-**) FR-E520-7.5K(C)(-**) FR-V520-7.5K(-**) FR-A720-7.5K(-**) FR-E720-7.5K(-**)

Note : ** indicates alpha numeric combination which means an inverter type such as A1 and A2.

High-Duty Brake Resistor Model		Applicable Inverter Models
200V Class	FR-ABR-11K	FR-V520-11K(-**) FR-A720-11K(-**) FR-E720-11K(-**)
	FR-ABR-15K	FR-V520-15K(-**) FR-A720-15K(-**) FR-E720-15K(-**)
	FR-ABR-22K	FR-A720-18.5K(-**) FR-A720-22K(-**)
400V Class	FR-ABR-H0.4K	FR-A540-0.4K(-**) FR-E540-0.4K(C)(-**) FR-A044-0.4K(-**) FR-A740-0.4K(-**) FR-E740-0.4K(-**)
	FR-ABR-H0.75K	FR-A540-0.75K(-**) FR-E540-0.75K(C)(-**) FR-A044-0.75K(-**) FR-A740-0.75K(-**) FR-E740-0.75K(-**)
	FR-ABR-H1.5K	FR-A540-1.5K(-**) FR-E540-1.5K(C)(-**) FR-V540-1.5K(-**) FR-A044-1.5K(-**) FR-A740-1.5K(-**) FR-E740-1.5K(-**)
	FR-ABR-H2.2K	FR-A540-2.2K(-**) FR-E540-2.2K(C)(-**) FR-V540-2.2K(-**) FR-A044-2.2K(-**) FR-A740-2.2K(-**) FR-E740-2.2K(-**)
	FR-ABR-H3.7K	FR-A540-3.7K(-**) FR-E540-3.7K(C)(-**) FR-V540-3.7K(-**) FR-A044-3.7K(-**) FR-A740-3.7K(-**) FR-E740-3.7K(-**)
	FR-ABR-H5.5K	FR-A540-5.5K(-**) FR-E540-5.5K(C)(-**) FR-V540-5.5K(-**) FR-A740-5.5K(-**) FR-E740-5.5K(-**)
	FR-ABR-H7.5K	FR-A540-7.5K(-**) FR-E540-7.5K(C)(-**) FR-V540-7.5K(-**) FR-A740-7.5K(-**) FR-E740-7.5K(-**)
	FR-ABR-H11K	FR-V540-11K(-**) FR-A740-11K(-**) FR-E740-11K(-**)
	FR-ABR-H15K	FR-V540-15K(-**) FR-A740-15K(-**) FR-E740-15K(-**)
	FR-ABR-H22K	FR-A740-18.5K(-**) FR-A740-22K(-**)

Note : ** indicates alpha numeric combination which means an inverter type such as A1 and A2.

2. GENERAL INSTRUCTIONS FOR INSTALLATION

(For compliance with UL standard, refer to page A-3.)

- Never mount the resistor near wood, paper or any other flammable material. Doing so can cause a fire.
- To prevent burns, do not install the resistor in a place where it is readily accessible. If it is easily accessible, mount in a well-ventilated enclosure (e.g. punched metal), suitable for the environment.
- Mount the resistor carefully so that the leads do not come from the top of the resistor.
- Avoid contact with the resistor when running the leads of the resistor and any other wiring.

Install the resistor in a place with good heat dissipation. The reason for this is that the surface temperature of the resistor may exceed 360°C in an operation pattern where the resistor is used frequently.

To increase the heat dissipation effect, we recommend you to install the resistor on a metal surface outside the enclosure.

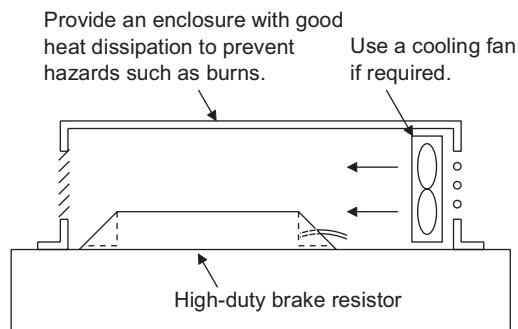

How to Install the Resistor

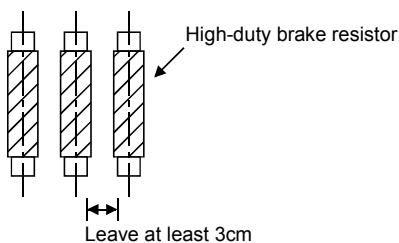

Interval between resistors Installed

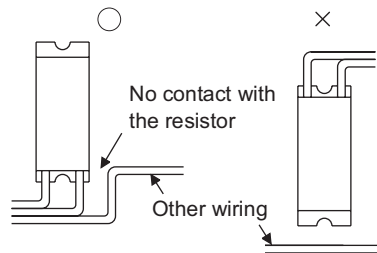

Orientation of installed resistor

3. INSTRUCTIONS FOR WIRING

When the regenerative brake transistor is damaged, the wiring sequence as shown in the following diagrams is recommended to prevent overheating and burnout of the brake resistor.

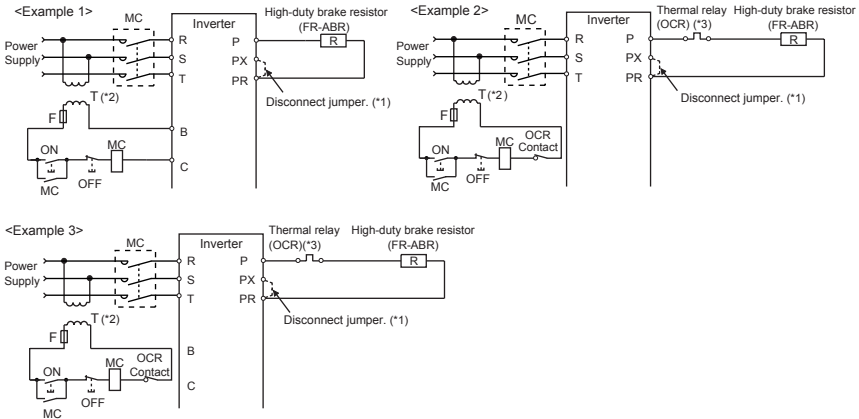

- Remove the jumper from across the PR-PX terminals of the inverter. (*1) This disables (switches off) the built-in brake resistor. (Refer to the instruction manual of the inverter for details.)
 Note that the built-in brake resistor need not be disconnected from the terminals.

- *1 When you use the FR-E500 series, the FR-E700 series, the FR-V500 series-7.5K or more, 11K or more and the FR-A700 series inverter, you need not remove the jumper since that inverter does not have the PX terminals. (Refer to the instruction manual of the inverter.)
- *2 For the 400V class power supply, install a voltage-reducing transformer.
- *3 Refer to the table below for the type number of each capacity of thermal relay and the diagram below for the connection. (Always install a thermal relay when using the 11K, 15K, 22K.)

Power Supply Voltage	High-duty Brake Resistor	Thermal Relay Type (Mitsubishi product)	Contact Rating
200V	FR-ABR-0.4K	TH-N20CXHZ-0.7A	110VAC 5A, 220VAC 2A(class AC-11) 110VDC 0.5A, 220VDC 0.25A(class DC-11)
	FR-ABR-0.75K	TH-N20CXHZ-1.3A	
	FR-ABR-2.2K	TH-N20CXHZ-2.1A	
	FR-ABR-3.7K	TH-N20CXHZ-3.6A	
	FR-ABR-5.5K	TH-N20CXHZ-5A	
	FR-ABR-7.5K	TH-N20CXHZ-6.6A	
	FR-ABR-11K	TH-N20CXHZ-11A	
	FR-ABR-15K	TH-N20CXHZ-11A	
	FR-ABR-22K	TH-N60-22A	
400V	FR-ABR-H0.4K	TH-N20CXHZ-0.24A	110VAC 5A, 220VAC 2A(class AC-11) 110VDC 0.5A, 220VDC 0.25A(class DC-11)
	FR-ABR-H0.75K	TH-N20CXHZ-0.35A	
	FR-ABR-H1.5K	TH-N20CXHZ-0.9A	
	FR-ABR-H2.2K	TH-N20CXHZ-1.3A	
	FR-ABR-H3.7K	TH-N20CXHZ-2.1A	
	FR-ABR-H5.5K	TH-N20CXHZ-2.5A	
	FR-ABR-H7.5K	TH-N20CXHZ-3.6A	
	FR-ABR-H11K	TH-N20CXHZ-6.6A	
	FR-ABR-H15K	TH-N20CXHZ-6.6A	
	FR-ABR-H22K	TH-N20-9A	

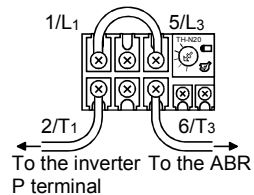

- Connect the leads of the high-duty brake resistor to the P and PR terminals of the inverter. When using the FR-ABR-15K, 22K, connect two high-duty brake resistors (18Ω) in parallel. When using the FR-ABR-H15K, connect two high-duty brake resistors (18Ω) in series using a terminal block enclosed.

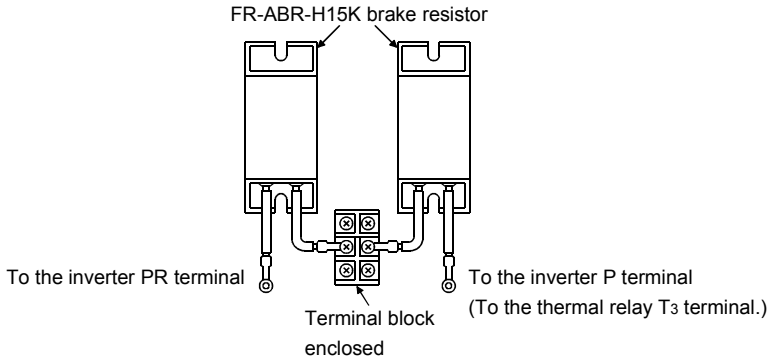

- If you extend the high-duty resistor lead wire to use, use the wire with a size as noted below and not exceeding 5m in length. Installation shall be in accordance with the North American or Canadian Electrical Code and any applicable provincial codes (codes of each state).

CAUTION

1. The high-duty brake resistor cannot be used with a brake unit, high power factor converter, power return converter, built-in brake etc.
 2. Twist the leads of the high-duty brake resistor when increasing their length 2m or more. (The wire size used should be minimum 14 AWG (2.1mm²)).
Note that even the twisted leads cannot be made longer than 5m. Doing so can cause an inverter failure.
 3. The FR-ABR-(H)11K, 15K, 22K can not be used with the FR-A500 series.
-
-

4. INSTRUCTIONS FOR USE

- Setting of inverter parameters
The parameter setting method varies with the inverter series. Refer to the instruction manual of the inverter.

5. SPECIFICATIONS

Permissible duty and torque

Item	FR-ABR-□ (200V Class)								FR-ABR-H□ (400V Class)									
	0.4K	0.75K	2.2K	3.7K	5.5K	7.5K	11K	15K	22K	0.4K	0.75K	1.5K	2.2K	3.7K	5.5K	7.5K	11K	15K
Braking torque	150% 5s		100% 5s								100% 5s							
Permissible duty*	10%ED				6%ED				10%ED				6%ED					

* The permissible duty represents the braking capability including the motor loss. The actual duty of the resistor is slightly lower than that.

6. OUTLINE DIMENSIONS

FR-ABR-0.4K to 7.5K, H0.4K to H7.5K

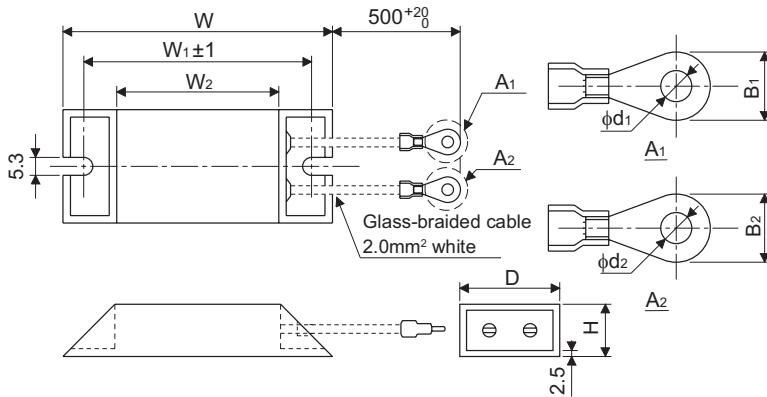

Brake Resistor Model		Dimensions (Unit: mm)					Resistance (Ω)	Crimping Terminal (Unit: mm)			
		W	W ₁	W ₂	D	H		A ₁		A ₂	
								B ₁	d ₁	B ₂	d ₂
200V Class	FR-ABR-0.4K	140	125	100	40	21	7.0	4.3	7.0	4.3	
	FR-ABR-0.75K	215	200	175	40	21					
	FR-ABR-2.2K*1	240	225	200	50	26					
	FR-ABR-3.7K	215	200	175	61	33	9.5	5.3	9.5	5.3	
	FR-ABR-5.5K	335	320	295	61	33					
	FR-ABR-7.5K	400	385	360	80	40					
400V Class	FR-ABR-H0.4K	115	100	75	40	21	7.0	4.3	7.0	4.3	
	FR-ABR-H0.75K	140	125	100	40	21					
	FR-ABR-H1.5K	215	200	175	40	21					
	FR-ABR-H2.2K	240	225	200	50	26					
	FR-ABR-H3.7K	215	200	175	61	33					
	FR-ABR-H5.5K	335	320	295	61	33					
	FR-ABR-H7.5K	400	385	360	80	40					

*1 Used for 1.5K and 2.2K.

FR-ABR-11K, 15K, 22K, H11K, H15K, H22K

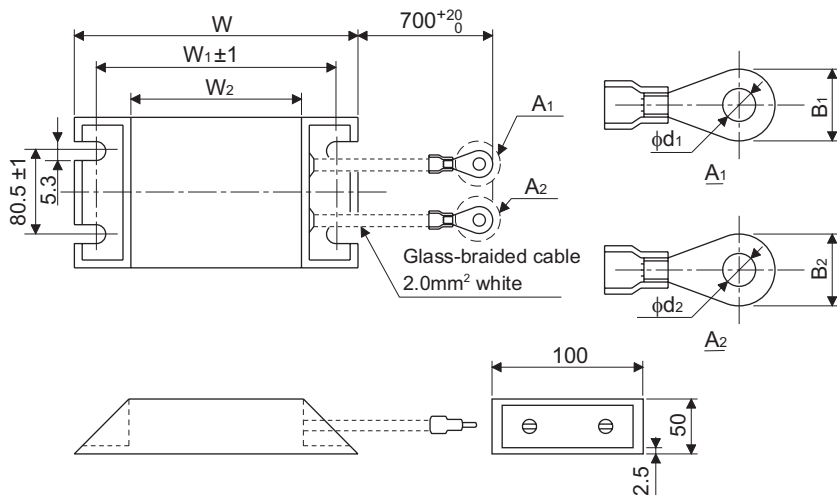

Brake Resistor Model		Dimensions (Unit: mm)			Resistance (Ω)	Crimping Terminal (Unit: mm)			
		W	W ₁	W ₂		A ₁		A ₂	
						B ₁	d ₁	B ₂	d ₂
200V Class	FR-ABR-11K	400	385	360	13	12	6.4	9.5	5.3
	FR-ABR-15K* ¹	300	285	260	18	12	8.4	12	8.4
	FR-ABR-22K* ³	400	385	360	13	12	8.4	12	8.4
400V Class	FR-ABR-H11K	400	385	360	52	12	6.4	9.5	5.3
	FR-ABR-H15K* ²	300	285	260	18	12	8.4	12	8.4
	FR-ABR-H22K* ⁴	450	435	410	52	9.0	6.4	9.0	6.4

*1 For the 15K, connect two resistors (18Ω) in parallel.

*2 For the H15K, connect two resistors (18Ω) in series. FR-ABR-15K is indicated on the resistor. (same resistor as the 200V class 15K)

*3 For the 22K brake resistor, configure so that two 13Ω resistors are connected in parallel. FR-ABR-22K is indicated on the resistor.

*4 For the H22K brake resistor, configure so that two 52Ω resistors are connected in parallel. FR-ABR-H22K is indicated on the resistor.

7. BRAKING CAPABILITIES

7.1 Continuous Permissible Power

200V Class			400V Class		
Model	Resistance	Continuous Permissible Power	Model	Resistance	Continuous Permissible Power
FR-ABR-0.4K	200Ω	60W	FR-ABR-H0.4K	1200Ω	45W
FR-ABR-0.75K	100Ω	80W	FR-ABR-H0.75K	700Ω	75W
FR-ABR-2.2K	60Ω	120W	FR-ABR-H1.5K	350Ω	115W
FR-ABR-3.7K	40Ω	155W	FR-ABR-H2.2K	250Ω	120W
FR-ABR-5.5K	25Ω	185W	FR-ABR-H3.7K	150Ω	155W
FR-ABR-7.5K	20Ω	340W	FR-ABR-H5.5K	110Ω	185W
FR-ABR-11K	13Ω	560W	FR-ABR-H7.5K	75Ω	340W
FR-ABR-15K	9Ω*1	805W	FR-ABR-H11K	52Ω	530W
FR-ABR-22K	6.5Ω*1	1120W	FR-ABR-H15K	36Ω*2	870W
			FR-ABR-H22K	26Ω*3	1060W

*1 When two resistors are connected in series.

*2 When two resistors are connected in series.

*3 When two resistors are connected in parallel.

7.2 Short-Duration Permissible Power per Braking

• 200V Class

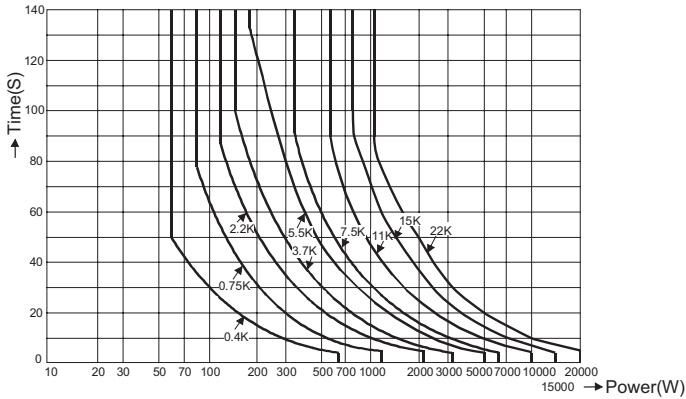

• 400V Class

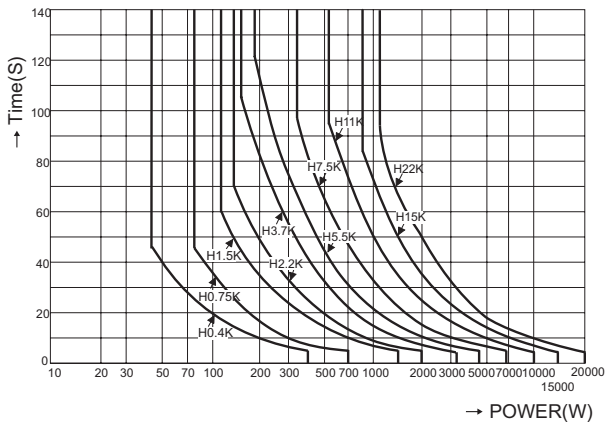

REVISIONS

*The manual number is given on the bottom left of the back cover.

Print Date	*Manual Number	Revision
Nov., 1998	IB(NA)-66891-A	First edition
Mar., 2001	IB(NA)-66891-B	<div style="border: 1px solid black; padding: 2px;">Partial Additions</div> <ul style="list-style-type: none"> • Applicable inverters • Instructions for wiring
Apr., 2002	IB(NA)-66891-C	<div style="border: 1px solid black; padding: 2px;">Additions</div> FR-ABR-11K, FR-ABR-15K
Aug., 2002	IB(NA)-66891-D	<div style="border: 1px solid black; padding: 2px;">Additions</div> FR-ABR-H11K, FR-ABR-H15K <div style="border: 1px solid black; padding: 2px;">Partial Addition</div> Instructions for wiring
Oct., 2003	IB(NA)-66891-E	<div style="border: 1px solid black; padding: 2px;">Additions</div> UL compliance
Mar., 2004	IB(NA)-66891-F	<div style="border: 1px solid black; padding: 2px;">Modifications</div> Outline dimensions, outline dimension drawings
Aug., 2005	IB(NA)-66891-G	<div style="border: 1px solid black; padding: 2px;">Additions</div> FR-ABR-22K
Nov., 2005	IB(NA)-66891-H	<div style="border: 1px solid black; padding: 2px;">Additions</div> <ul style="list-style-type: none"> • FR-ABR-H22K • FR-A740 specifications
Aug., 2008	IB(NA)-66891-J	<div style="border: 1px solid black; padding: 2px;">Partial Addition</div> Applicable inverters