

Temperature Controllers

Digital Temperature Controllers Basic Type

E5□N

Simplicity on the Worksite

Solutions Guide for FAQs



Basic Setup Procedure

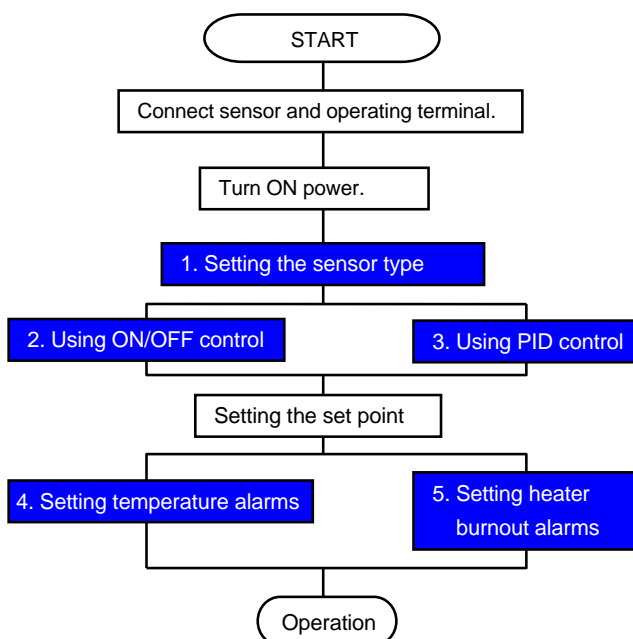

CONTENTS

1. Setting the Sensor Type
2. Using ON/OFF Control
3. Using PID Control
4. Setting Temperature Alarms
5. Setting Heater Burnout Alarms

Introduction

This Solutions Guide is based on customer questions that were received at OMRON's Customer Support Center. It provides practical operating procedures for setting and changing the most common items: setting the sensor type, ON/OFF control, PID control, setting temperature alarms, and setting heater burnout alarms.

Keep this Guide in a convenient location onsite to help you make settings and changes.

If you are having trouble with Temperature Controller settings, this is the guidebook for you.

© OMRON, 2010

All rights reserved. No part of this publication may be reproduced, stored in a retrieval system, or transmitted, in any form, or by any means, mechanical, electronic, photocopying, recording, or otherwise, without the prior written permission of OMRON.

No patent liability is assumed with respect to the use of the information contained herein. Moreover, because OMRON is constantly striving to improve its high-quality products, the information contained in this manual is subject to change without notice. Every precaution has been taken in the preparation of this manual. Nevertheless, OMRON assumes no responsibility for errors or omissions. Neither is any liability assumed for damages resulting from the use of the information contained in this publication.

Setting the Sensor Type

Select and set the sensor type (i.e., the Input Type parameter) to the set value that corresponds to the type of sensor used in the application and the required temperature range. The parameter is set to 5 (K thermocouple at -200 to 1,300 °C) by default.

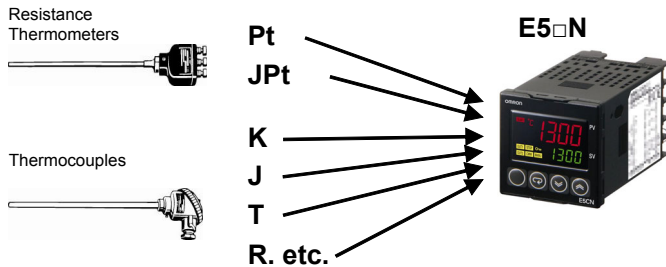

The set values (SVs) for the Input Type parameter depend on when the E5□N-series Temperature Controller was sold. Check your Temperature Controller and set the correct value.

Current Temperature Controllers

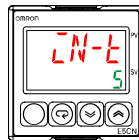

Previous Temperature Controllers

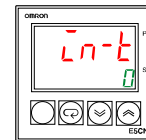

Input type	Sensor type	Input temperature setting range	SV for models with 11-segment displays	SV for models with 7-segment displays
Resistance Thermometer	Pt100	-200 to 850 °C	0	0 (default)
		-199.9 to 500.0 °C	1	1
		0.0 to 100.0 °C	2	2
	JPt100	-199.9 to 500.0 °C	3	3
		0.0 to 100.0 °C	4	4
Thermocouples	K	-200 to 1300 °C	5 (default)	0 (default)
		-20.0 to 500.0 °C	6	1
	J	-100 to 850 °C	7	2
		-20.0 to 400.0 °C	8	3
	T	-200 to 400 °C	9	4
		-199.9 to 400.0 °C	10	17
	E	-200 to 600 °C	11	5
	L	-100 to 850 °C	12	6
	U	-200 to 400 °C	13	7
		-199.9 to 400.0 °C	14	18
	N	-200 to 1300 °C	15	8
	R	0 to 1700 °C	16	9
	S	0 to 1700 °C	17	10
B	100 to 1800 °C	18	11	
W	0 to 2300 °C	24	Not supported.	
PLII	0 to 1300 °C	25	Not supported.	

Any value can be set for any model.

The Temperature Controller models are different for resistance thermometers and thermocouples.

* When using the ES1B Infrared Temperature Sensor and an analog input, refer to the E5CN/E5AN/E5EN/E5GN Digital Temperature Controllers User's Manual, Basic Type (Cat. No. H156).

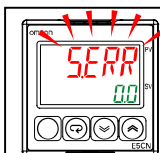

← If the setting of the Input Type parameter does not agree with the connected sensor, s.err (S.ERR: Input Error) will flash on the display as shown at the left when the power supply is turned ON.

Use the procedure on page 1-2 to set the Input Type parameter correctly.

Setting the Sensor Type

1 Setting the Sensor Type

You set this parameter in the Initial Setting Level.

The parameter is set to 5 (K thermocouple at -200 to 1,300 °C) by default.

1 Turn ON the power supply.

Operating Display

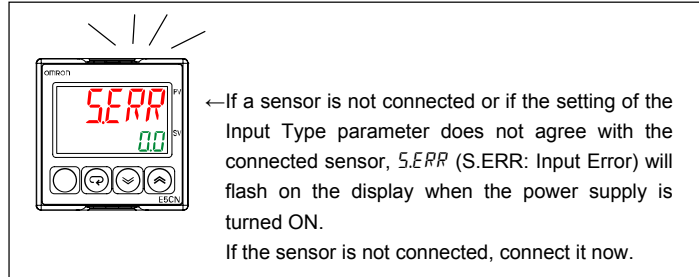
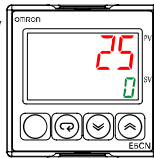

2 Press the Key for at least 3 seconds.

Press the (Level) Key for at least 3 seconds.



Initial Setting Level

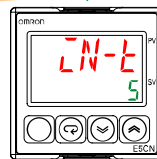

3 Set the parameter with the Keys

Initial Setting Level

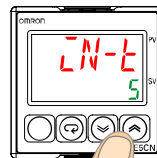

Initial Setting Level

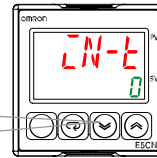

Change the set value with the (Up and Down) Keys.

Set the number that you selected for the Input Type parameter on page 1-1.

(When finished, press the (Level) Key for at least 1 second to return to the operation display.)

Using ON/OFF Control

The procedure to use ON/OFF control is given step by step in this section.

Step 1 Determining the Control Method

1 Select direct or reverse operation.

The default setting is for reverse operation.

For heating control, select reverse operation.

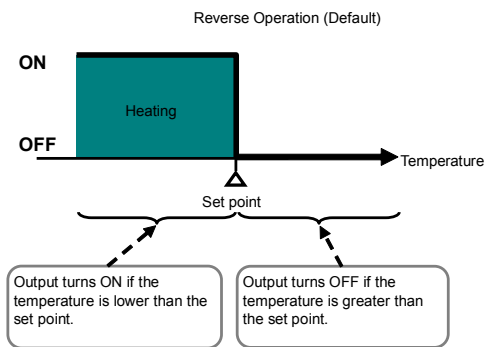

For cooling control, select direct operation.

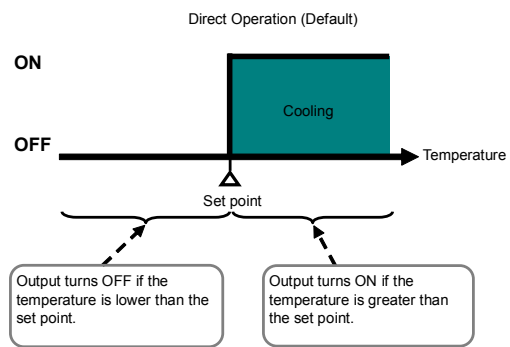

2 Adjust the hysteresis.

With ON/OFF control, you can adjust the reset width (called the hysteresis) for heating or cooling operation. The default setting is 1.0°C.

Heating (Reverse) Operation

When the output turns OFF at the set point, the temperature will decrease. You can set the temperature width that determines when the output will turn ON again.

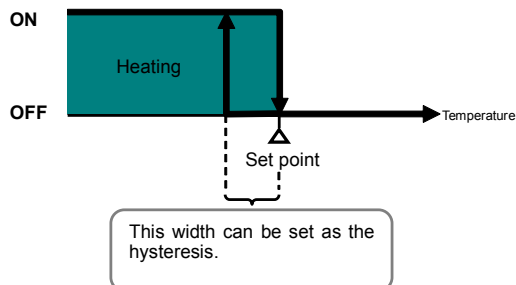

Cooling (Direct) Operation

When the output turns OFF at the set point, the temperature will increase. You can set the temperature width that determines when the output will turn ON again.

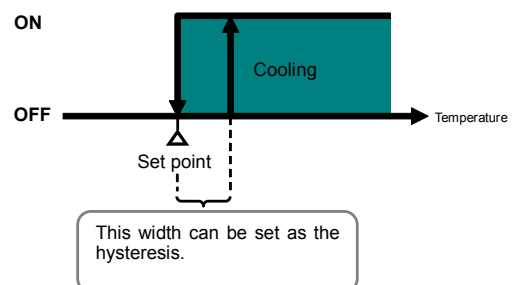

Using ON/OFF Control

Step 2 Setting ON/OFF Control Parameters

1 Setting ON/OFF Control

You set this parameter in the Initial Setting Level. The parameter is set to ON/OFF control by default.

1 Turn ON the power supply.

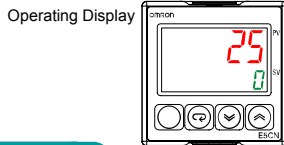

2 Press the Key for at least 3 seconds.

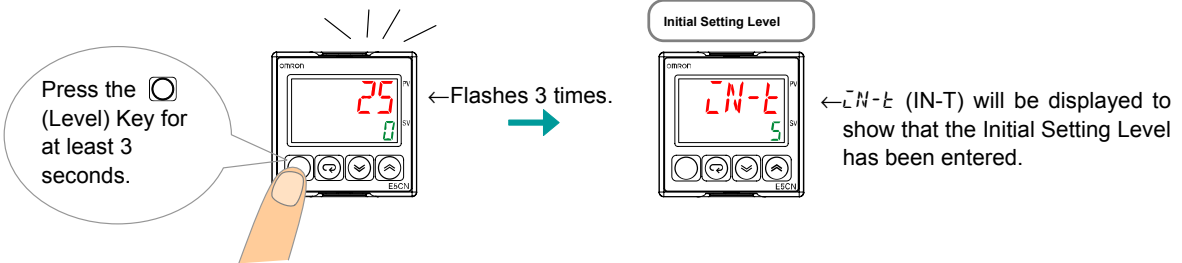

3 Change the parameter with the Key.

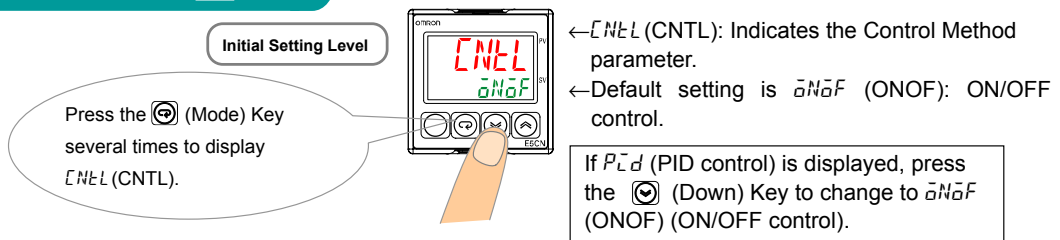

2 Setting Direct or Reverse Operation

You set this parameter in the Initial Setting Level. The parameter is set to reverse operation by default.

1 Change the parameter with the Key.

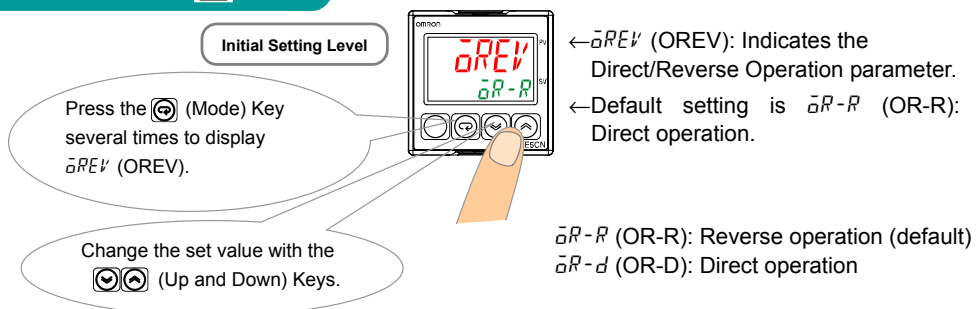

(When finished, press the (Level) Key for at least 1 second to return to the operation display.)

3 Setting the Hysteresis

You set this parameter in the Adjustment Level. The parameter is set to 1.0°C by default.

1 Turn ON the power supply.

Press the  (Level) Key for less than 1 second.

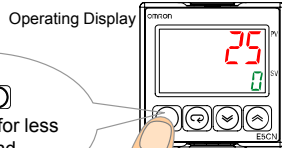

Adjustment Level

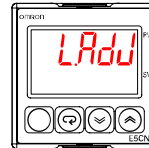

← *LAdj* (L.ADJ) will be displayed to show that the Adjustment Level has been entered.

2 Change the parameter with the Key.

Press the  (Mode) Key several times to display *HYS* (HYS).

Adjustment Level

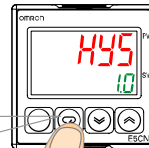



← *HYS* (HYS): Indicates the Hysteresis parameter.

← Default setting is *1.0* (1.0°C).

3 Set the parameter with the Keys.

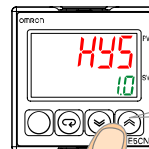
Adjustment Level



Change the set value with the   (Up and Down) Keys.

(When finished, press the  (Level) Key to return to the operation display.)

Using ON/OFF Control

MEMO

Using ON/OFF Control

Using PID Control

The procedure to use PID control is given step by step in this section.

Step 1 Determining the Control Method

1 Select direct or reverse operation.

The default setting is for reverse operation.

For heating control, select reverse operation.

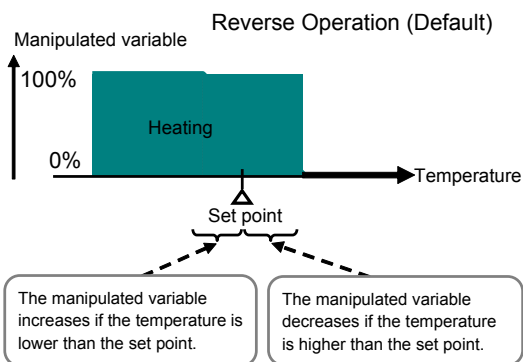

For cooling control, select direct operation.

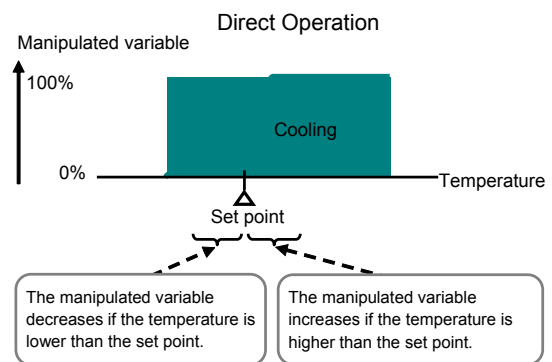

2 Adjust the PID constants.

You can automatically or manually set the PID constants that are used for PID control.

Adjusting the PID Constants

The suitable values of the PID constants that are used for temperature control depend on the characteristics of the controlled object.

There are three ways that you can use to set the PID constants. These are described below.

If you can allow the temperature to vary while tuning the PID constants and you need to calculate the optimum PID constants:

⇒ Use autotuning (AT).

If you know the PID constants in advance:

⇒ Set the PID constants manually.

If you cannot allow the temperature to vary and you need to automatically estimate the PID constants when the set point is changed:

With self-tuning, calculation of the PID constants is affected by changes in the temperature, such as when a heater is turned ON and OFF. The PID constants will be automatically calculated and set. If there is an external source that causes temperature changes (such as a heater turning OFF), use autotuning or set the PID constants manually.

⇒ Use self-tuning (ST).

Using PID Control

Step 2 Setting PID Control Parameters

1 Setting PID Control

You set this parameter in the Initial Setting Level. The parameter is set to ON/OFF control by default.

1 Turn ON the power supply.

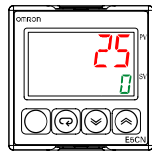

2 Press the Key for at least 3 seconds.

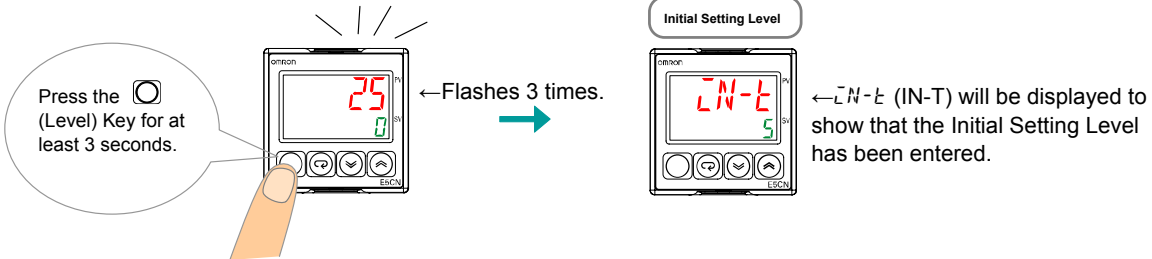

3 Change the parameter with the Key.

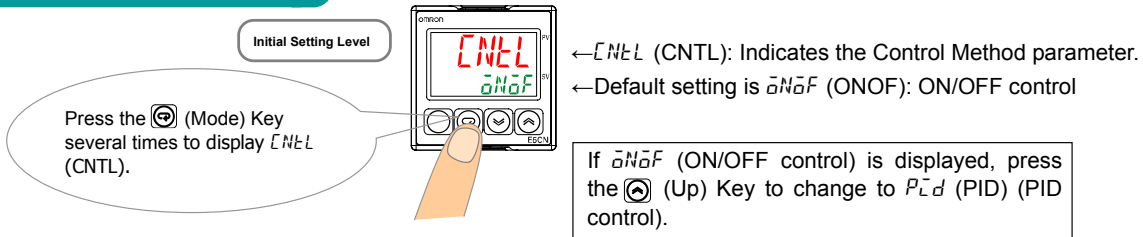

4 Change the parameter with the Key.

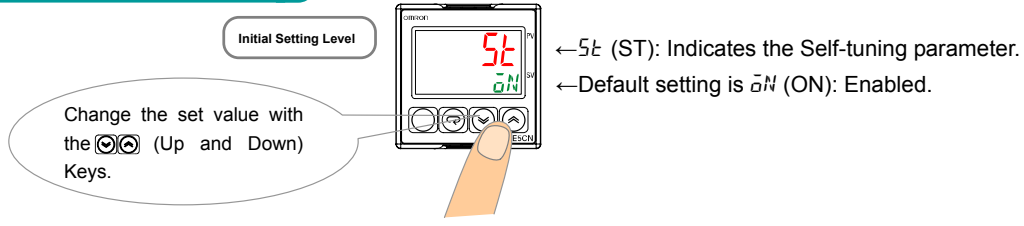

You cannot set the following parameters while self-tuning is enabled.

- Adjustment Level: MV Upper Limit, MV Lower Limit, and SP Ramp Set Value
- Advanced Function Setting Level: SP Ramp Time Unit

* To set these parameters, first set the ST (ST) (self-tuning) parameter in the Initial Setting Level to OFF (OFF) to disable self-tuning.

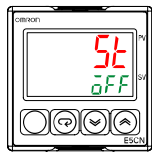

OFF (OFF): Self-tuning disabled. Use this setting to perform autotuning or to set the PID constants manually.

ON (ON): Self-tuning enabled. Use this setting to perform self-tuning

(Refer to **2. Adjusting PID Constants** on page 3-1.)

Using PID Control

2 Setting direct or reverse operation.



You set this parameter in the Initial Setting Level. The parameter is set to reverse operation by default.

1 Change the parameter with the  Key.



Initial Setting Level

Press the  (Mode) Key several times to display $\bar{O}RE\bar{V}$ (OREV).

Change the set value with the   (Up and Down) Keys.

$\bar{O}RE\bar{V}$ (OREV): Indicates the Direct/Reverse Operation parameter.
 ← Default setting is $\bar{O}R-R$ (OR-R): Direct operation



$\bar{O}R-R$ (OR-R): Reverse operation (default)
 $\bar{O}R-d$ (OR-D): Direct operation

(When finished, press the  (Level) Key for at least 1 second to return to the operation display.)

Using PID Control

Executing Autotuning

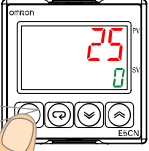
1 Turn ON the power supply.

Operating Display  → Adjustment Level 

Press the  (Level) Key for less than 1 second.

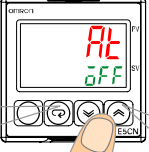

←L.ADJ(L.ADJ) will be displayed to show that the Adjustment Level has been entered.

2 Change the parameter with the  Key.

Adjustment Level 

Press the  (Mode) Key several times to display AT (AT).

←AT (AT): Indicates the Autotuning parameter.
 ←Default setting is OFF (OFF): Autotuning stopped.

Use the   (Up and Down) Keys to select AT-2 (AT-2) (100% autotuning).

3 Autotuning will start at AT-2

Adjustment Level 

Autotuning will be started when AT (AT) ←starts flashing.
 ←AT-2 (AT-2): 100% autotuning executed.

OFF (OFF) : Autotuning stopped (default).
 AT-2 (AT-2) : 100% autotuning executed.
 AT-1 (AT-1) : Refer to page 3-6.

4 AT stops flashing, autotuning is finished.

Adjustment Level 

←AT will stop flashing to indicate that autotuning is finished.

(When finished, press the  (Level) Key to return to the operation display.)
 *You can return to the Operation Level during autotuning execution.

- After Returning to Operation Level

Operating Display

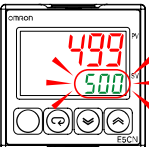

←SV flashing: Autotuning is being executed.

Setting PID Constants Manually

You set the PID constants manually in the Adjustment Level.

The default settings of the PID constants are as follows: P (proportional band) = 8.0°C, I (integral time) = 233 seconds, D (derivative time) = 40 seconds.

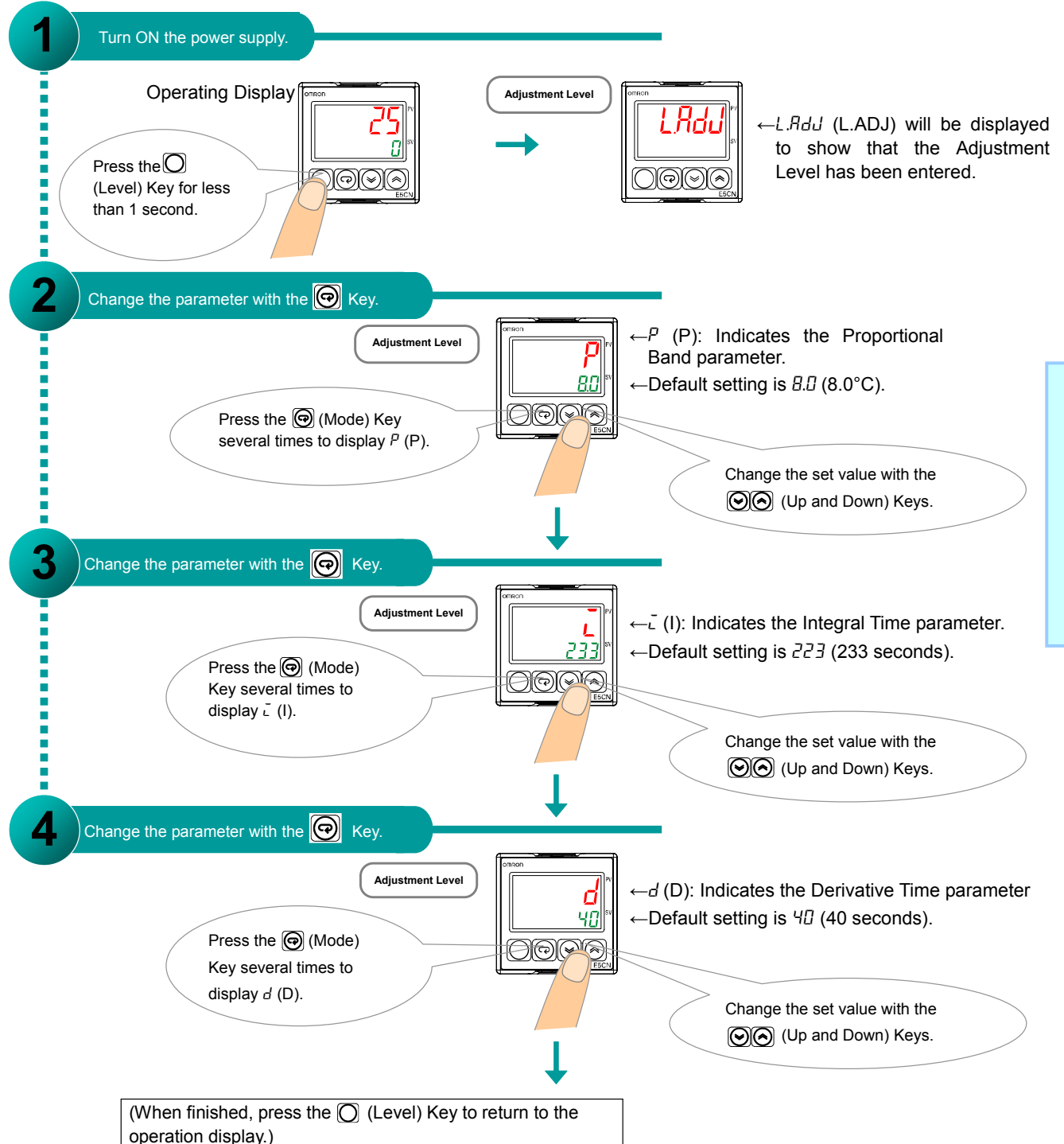

Using PID Control

Reference Information: PID Control

Problems with 100% Autotuning (AT-2)

If autotuning at 100% (AT-2) does not produce the desired results, you can also execute autotuning at 40% (AT-1).

•Autotuning at 40% (AT-1)

A 40% variation in the manipulated variable of the limit cycle is used for autotuning. Executing 40% autotuning may require more time than executing 100% autotuning (AT-2).

The limit cycle timing varies according to whether the deviation (DV) at the start of autotuning execution is less than 10% FS.

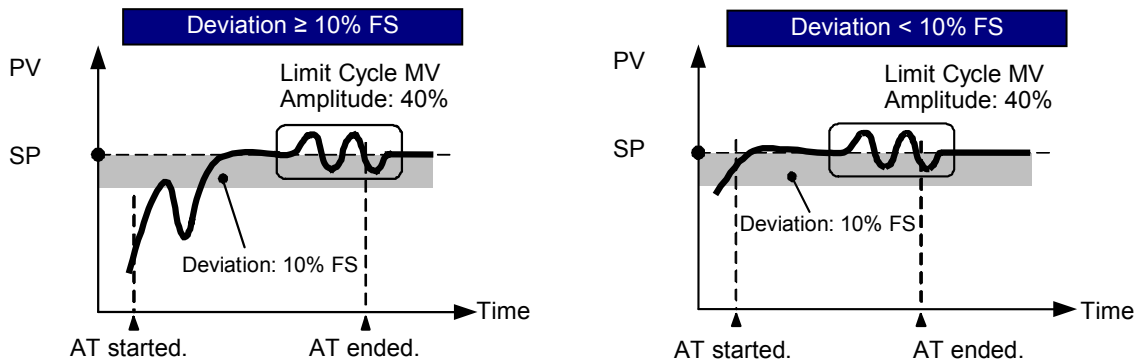

Using PID Control

Setting Temperature Alarms

The procedure to set temperature alarms is given step by step in this section.

Step 1 Determining the Alarm Set Value

1 Selecting the Alarm Type

How To Select an Alarm Type

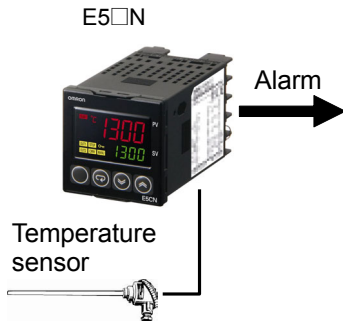

Consider the following three points and select the alarm type from tables on page 4-3 and 4-4.

1. In what cases do you want to output an alarm?
2. Do you need to link the alarm temperature to the set point?
3. Do you need an alarm when the power is turned ON.

1. In what cases do you want to output an alarm?

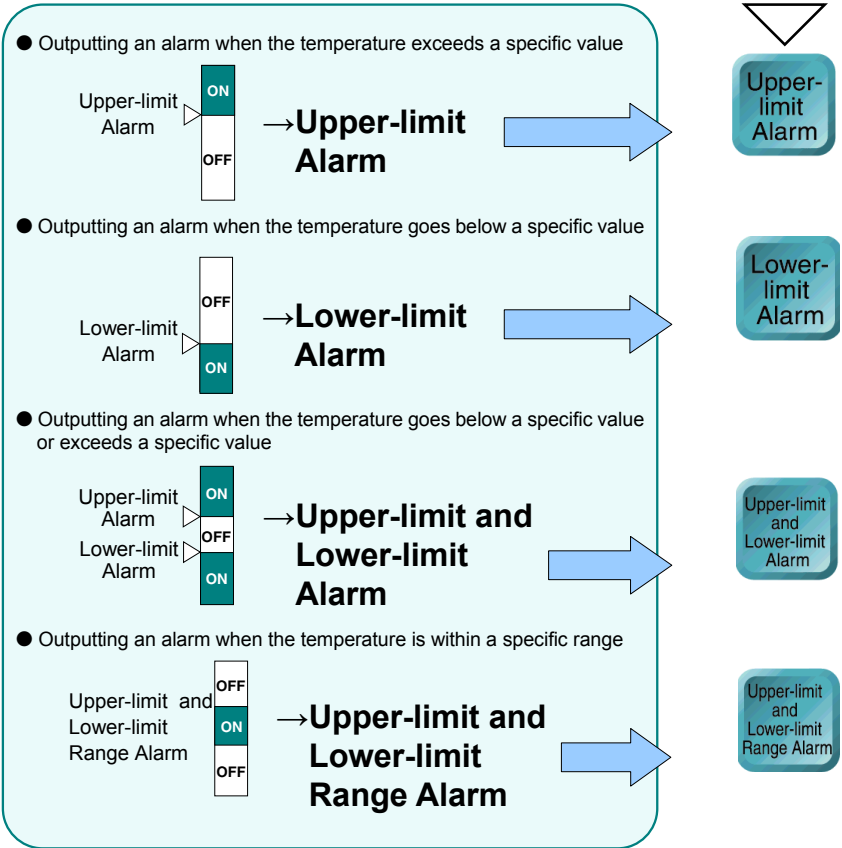

Setting Temperature Alarms

Setting Temperature Alarms

2. Do you need to link the alarm temperature to the set point?

- Alarm linked to the set point
If the set point is changed, the set value of the alarm will also change.

Set this difference.

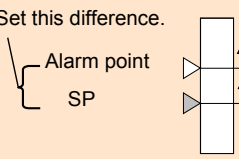

Alarm point SP → **Set the difference (deviation) between the set point and alarm point.**

- Alarm not linked to the set point
The actual temperature at which the alarm is output is set.

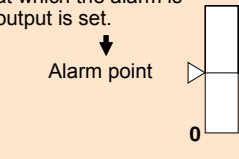

Alarm point 0 → **Set the absolute temperature at which the alarm is output.**

Select from the table on page 4-3.



3. Do you need an alarm when the power is turned ON?

- Alarm not required when the power is turned ON

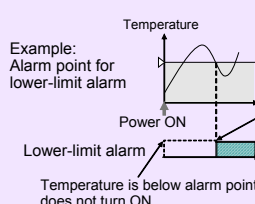

Example: Alarm point for lower-limit alarm
Power ON
Lower-limit alarm
Temperature is below alarm point, but alarm output does not turn ON.

→ **Standby Sequence**

- Alarm also required when power is turned ON

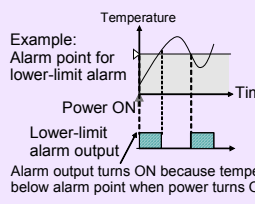

Example: Alarm point for lower-limit alarm
Power ON
Lower-limit alarm output
Alarm output turns ON because temperature is below alarm point when power turns ON.

→ **No Standby Sequence**

Select from the table on page 4-3.



What Is a Standby Sequence For?
Particularly with a lower-limit alarm, the temperature is often below the alarm point when temperature control is started. In this case, an alarm would be output at the start of operation. To prevent this, a standby sequence is used to disable the first alarm.

Setting Temperature Alarms

In the default settings, the standby sequence is restarted (and the alarm is turned OFF) when operation is started, when the SP is changed, or when the alarm temperature is changed.

You can change the conditions for restarting the standby sequence.

For details, refer to the *E5CN/E5AN/E5EN/E5GN Digital Temperature Controllers User's Manual, Basic Type* (Cat. No. H156).

Setting Temperature Alarms









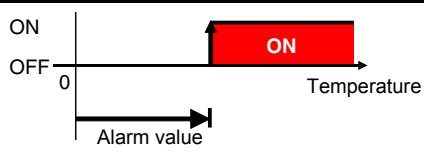

Available Alarm Types

You select the alarm type according to the required conditions.

Do you want to link the alarm temperature to the set point?	Do you need a standby sequence?	In what cases do you want to output an alarm?	Alarm Type		Operation
			No.	Name	
-	-	None	⇒	0 No alarm	Set this alarm type when you do not need an alarm.
Deviation	No Standby Sequence	Upper-limit and Lower-limit Alarm	⇒	1 Upper-limit and Lower-limit Alarm	
		Upper-limit Alarm	⇒	2 Upper-limit Alarm	
		Lower-limit Alarm	⇒	3 Lower-limit Alarm	
		Upper-limit and Lower-limit Range Alarm	⇒	4 Upper-limit and Lower-limit Range Alarm	
	Standby Sequence	Upper-limit and Lower-limit Alarm	⇒	5 Upper-limit and Lower-limit Alarm with Standby Sequence	
		Upper-limit Alarm	⇒	6 Upper-limit Alarm with Standby Sequence	
		Lower-limit Alarm	⇒	7 Lower-limit Alarm with Standby Sequence	

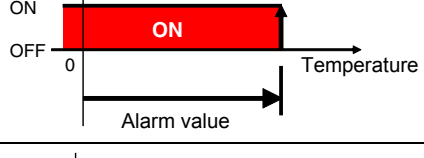
Setting Temperature Alarms

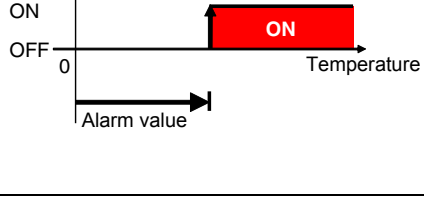
Setting Temperature Alarms

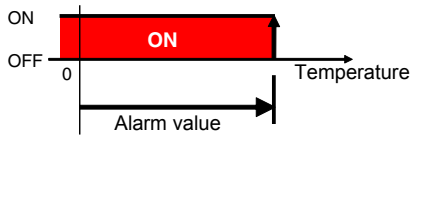
Do you want to link the alarm temperature to the set point?	Do you need a standby sequence?	In what cases do you want to output an alarm?	Alarm Type		Operation	
			No.	Name		
			<p>Set this number in the Temperature Controller</p> <p>You use these numbers for the following Alarm Type parameters: <i>AL L 1</i> (ALT1), <i>AL L 2</i> (ALT2), and <i>AL L 3</i> (ALT3). Refer to page 4-6 for the procedure.</p>			
					8 Absolute-value Upper-limit Alarm	
					9 Absolute-value Lower-limit Alarm	
					10 Absolute-value Upper-limit Alarm with Standby Sequence	
			11 Absolute-value Lower-limit Alarm with Standby Sequence			

* Refer to the *E5CN/E5AN/E5EN/E5GN Digital Temperature Controllers User's Manual, Basic Type* (Cat. No. H156) for information on alarm types 12 (LBA) and 13 (PV Change Rate Alarm).

2 Determining the Alarm Value

What Value Is Set for an Alarm?

You set the temperature at which the alarm is output. There are two methods to set the temperature for the alarm types selected on pages 4-3 and 4-4: a deviation or an absolute temperature. Either positive or negative values can be set for the alarm value.

● Setting Deviations from the Set Point

- Setting an Upper-limit Alarm (Alarm Type 2)

Example: Alarm Value = 20

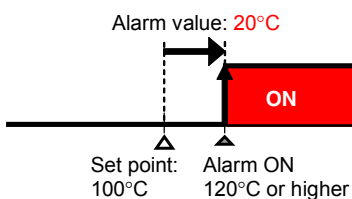

Example: Alarm Value = -20

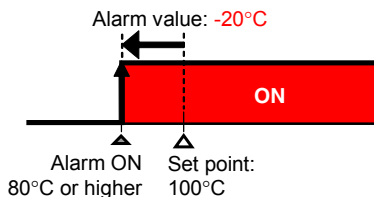

- Setting a Lower-limit Alarm (Alarm Type 3)

Example: Alarm Value = 20

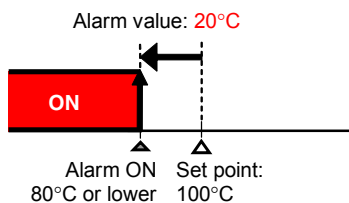

Example: Alarm Value = -20

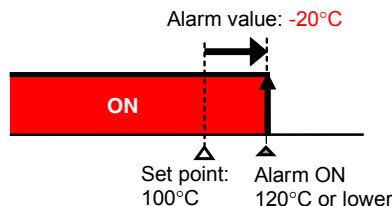

- Setting an Upper-limit Lower-limit Alarm (Alarm Type 1)

Example: Alarm upper limit = 30, alarm lower limit = 20

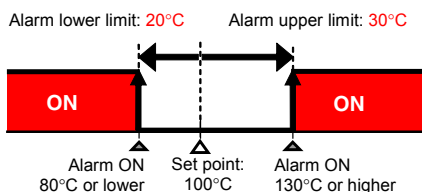

● Setting Absolute Temperatures

- Setting an Absolute-value Upper-limit Alarm (Alarm Type 8)

The alarm output will turn ON when the alarm value is exceeded regardless of the value of the set point.

Example: Alarm Value = 100

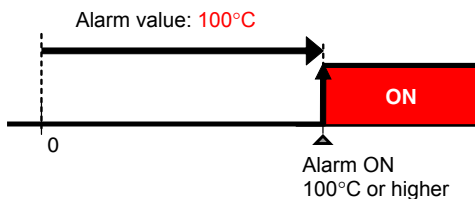

- Setting an Absolute-value Lower-limit Alarm (Alarm Type 9)

The alarm output will turn ON when the temperature is below the alarm value regardless of the value of the set point.

Example: Alarm Value = 100

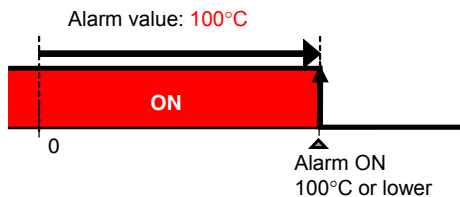

*There is no upper-limit lower-limit alarm that can be set with absolute values.

Setting Temperature Alarms

Step 2 Setting Alarm Parameters

1 Setting the Alarm Type

You set this parameter in the Initial Setting Level. The parameter is set to 2 (Upper-limit Alarm) by default.

1 Turn ON the power supply.

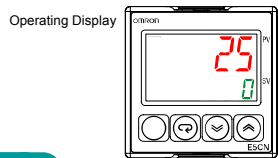

2 Press the Key for at least 3 seconds.

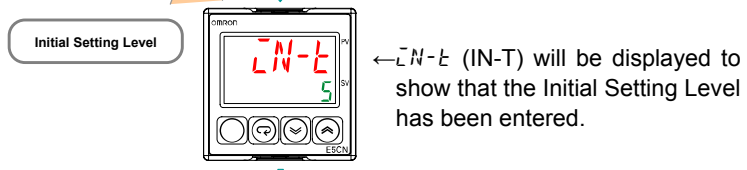
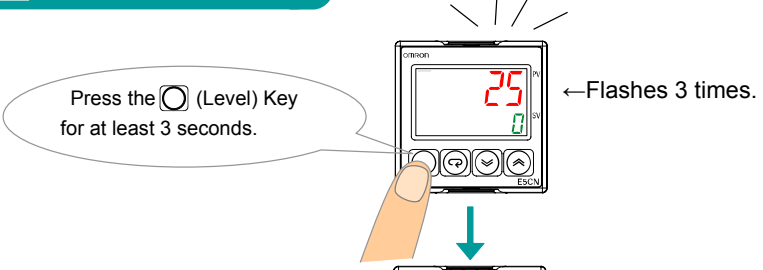

3 Change the parameter with the Key.

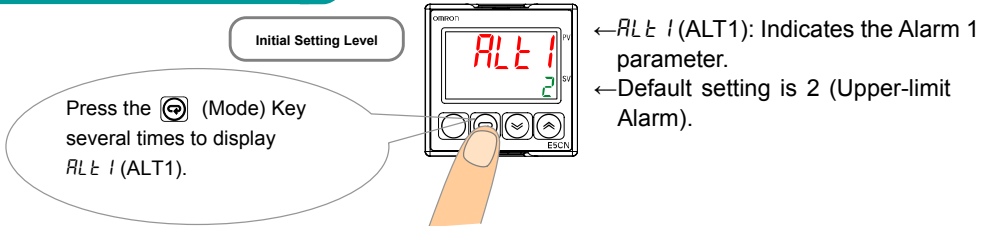

4 Set the parameter with the Keys.

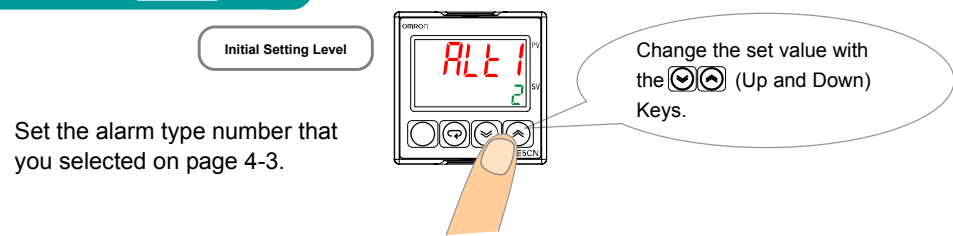

If required, use the (Mode) Key and the (Up and Down) Keys to repeat steps 3 and 4 and set alarm type numbers for ALt 2 (ALT2) (Alarm 2) and ALt 3 (ALT3) (Alarm 3).
(The number of alarms that is supported depends on the model of Temperature Controller. Some of the alarm parameters may not be displayed.)

(When finished, press the (Level) Key for at least 1 second to return to the operation display.)

Setting Temperature Alarms

2 Setting the Alarm Value

You set the alarm value in the Operation Level.

The following procedure continues on from the procedure to set the Alarm Type parameter (Initial Setting Level).

Start here if you just turned ON the power supply.

1 Press the  Key for at least 1 second.

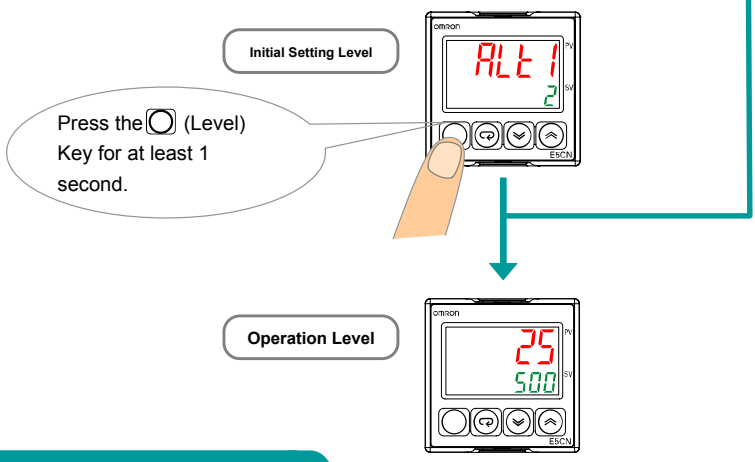

2 Change the parameter with the  Key.

Setting Alarm Type **2, 3, 6, 7, 8, 9, 10, or 11** (Upper-limit Alarms and Lower-limit Alarms)

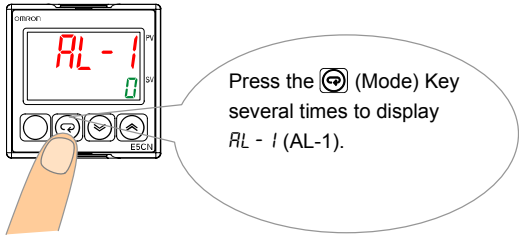

Setting Alarm Type **1, 4, or 5** (Upper-limit and Lower-limit Alarms or Upper-limit and Lower-limit Range Alarms)

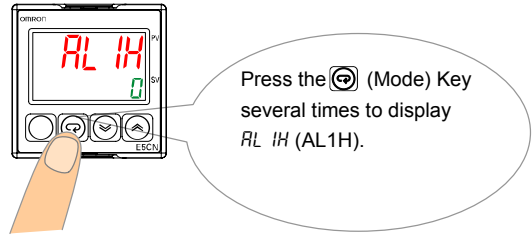

Setting Temperature Alarms

Setting Temperature Alarms

3

Set the alarm value with the  Keys.

Setting Alarm Type 2, 3, 6, 7, 8, 9, 10, or 11 (Upper-limit Alarms and Lower-limit Alarms)

Example:
Alarm Value 1 = Upper-limit Alarm: 30°C

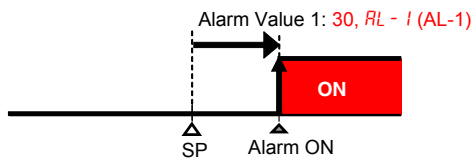

Operation Level

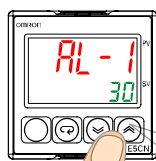

← *RL - 1* (AL-1): Alarm Value 1
Alarm value: 30°C (example)

Change the set value with the  (Up and Down) Keys.

Setting Alarm Type 1, 4, or 5 (Upper-limit and Lower-limit Alarms or Upper-limit and Lower-limit Range Alarms)

Example:
Alarm Upper Limit 1 = 30°C,
Alarm Lower Limit 1 = 20°C

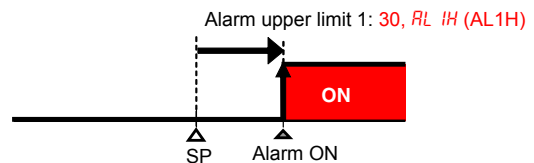

Alarm lower limit 1: 20, *RL 1L* (AL1L)

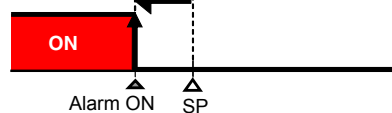

Operation Level

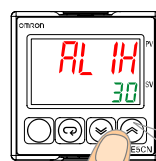

← *RL 1H* (AL1H): Alarm Upper Limit 1
Alarm value: 30°C (example)

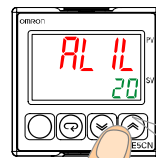

Change the set value with the  (Up and Down) Keys.

Press the  (Mode) Key several times to display *RL 1L* (AL1L).



← *RL 1L* (AL1L): Alarm lower limit 1
Alarm value: 20°C (example)

Change the set value with the  (Up and Down) Keys.

If required, use the  (Mode) Key and the  (Up and Down) Keys to repeat steps 2 and 3 and set the alarm values for *RL - 2* (AL-2) (Alarm Value 2), *RL - 3* (AL-3) (Alarm Value 3), *RL 2H* (AL2H) (Alarm Upper Limit 2), *RL 2L* (AL2L) (Alarm Lower Limit 2), *RL 3H* (AL3H) (Alarm Upper Limit 3), and *RL 3L* (AL3L) (Alarm Lower Limit 3). (The number of alarms that is supported depends on the model of Temperature Controller. Some of the alarm parameters may not be displayed.)

(When finished, press the  (Mode) Key to return to the operation display.)

Step 3 Additional Settings as Required

1 Determining the Alarm Hysteresis (Deviation between ON and OFF)

What Is Alarm Hysteresis?

The alarm hysteresis is the difference between the temperature where the alarm output turns ON and the temperature where it turns OFF.

The default setting is 0.2°C

- Setting Hysteresis for an Upper-limit Alarm (Alarm Type 2)

Example: Hysteresis = 1

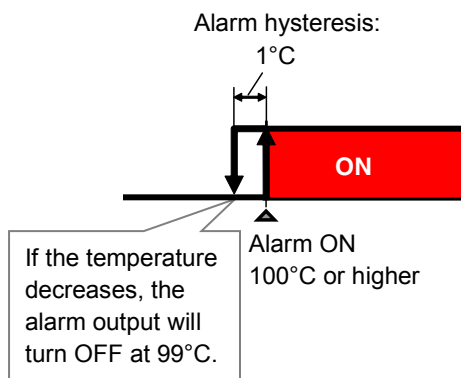

- Setting Hysteresis for a Lower-limit Alarm (Alarm Type 3)

Example: Hysteresis = 1

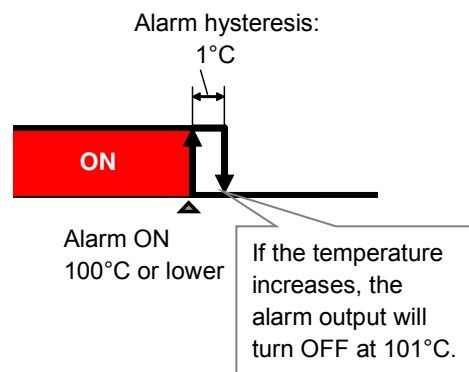

- Setting Hysteresis for an Upper-limit Lower-limit Alarm (Alarm Type 1)

Example: Hysteresis = 1

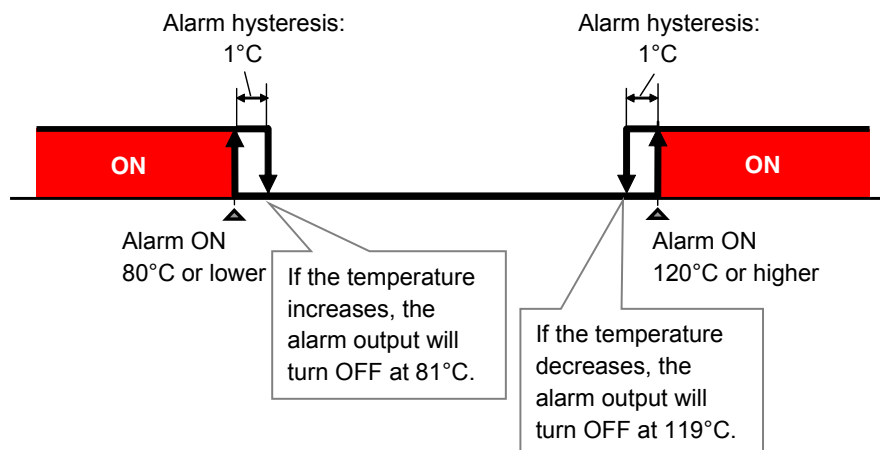

Note: The same hysteresis is used for the upper and lower limits of an upper-limit and lower-limit alarm and an upper-limit and lower-limit range alarm

Setting Temperature Alarms

2 Setting the Hysteresis

You set this parameter in the Initial Setting Level. The parameter is set to 0.2°C by default.

1 Turn ON the power supply.

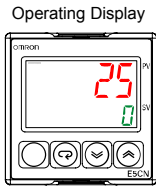

2 Press the Key for at least 3 seconds.

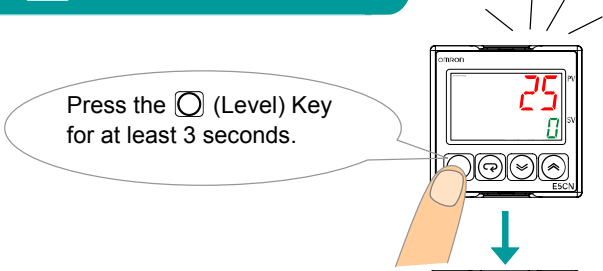

Initial Setting Level

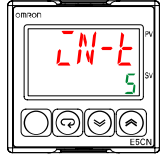

← IN-T (IN-T) will be displayed to show that the Initial Setting Level has been entered.

3 Change the parameter with the Key.

Initial Setting Level

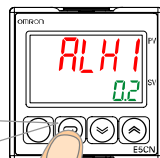
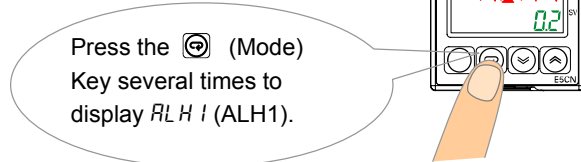

ALH1 (ALH1):
← Indicates the Alarm 1 Hysteresis parameter.
← Default setting is 0.2°C.

4 Set the parameter with the Keys.

Initial Setting Level

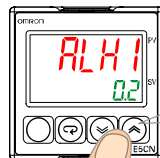

Change the set value with the (Up and Down) Keys

Setting Temperature Alarms

If required, use the (Mode) Key and the (Up and Down) Keys to repeat steps 3 and 4 and set the hysteresis for *ALH2* (ALH2) (Alarm 2 Hysteresis) and *ALH3* (ALH3) (Alarm 3 Hysteresis) (The number of alarms that is supported depends on the model of Temperature Controller. Some of the alarm parameters may not be displayed.)

(When finished, press the (Level) Key for at least 1 second to return to the operation display.)

Reference Information: Other Related Settings

Reversing Outputs

You can reverse the status of an auxiliary output (alarm output) before it is actually output.

With the default setting, the output will be ON when the alarm is ON and OFF when the alarm is OFF (NO: Close in Alarm).

You can change the setting so that the output will be ON when the alarm is OFF and OFF when the alarm is ON (NC: Open in Alarm).

1

Go to the Advanced Function Setting Level.

Refer to page 4-14 for the procedure to enter the Advanced Function Setting Level.

Advanced Function Setting Level

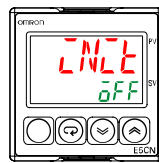

← INIT (INIT) will be displayed to show that the Advanced Function Setting Level has been entered.

2

Change the parameter with the  Key.

Press the  (Mode) Key several times to display *Sb IN* (SB1N).

Advanced Function Setting Level

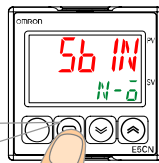

Sb IN (SB1N): Indicates the Auxiliary Output 1 Open in Alarm parameter.



← Default setting is *N-O* (N-O): Close in Alarm

3

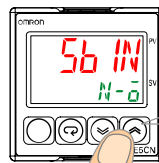

Set the parameter with the   Keys.

Advanced Function Setting Level



Change between Open in Alarm and Close in Alarm with the   (Up and Down) Keys.

N-O (N-O): Close in Alarm
N-C (N-C): Open in Alarm

If required, use the  (Mode) Key and the   (Up and Down) Keys to repeat steps 2 and 3 and set Open in Alarm or Close in Alarm for *Sb2N* (SB2N) (Auxiliary Output 2 Open in Alarm) and *Sb3N* (SB3N) (Auxiliary Output 3 Open in Alarm).

(The number of auxiliary outputs that is supported depends on the model of Temperature Controller. Some of the auxiliary output parameters may not be displayed.)

(When finished, press the  (Level) Key for at least 1 second to return to the Initial Setting Level.)

* For details, refer to the *E5CN/E5AN/E5EN/E5GN Digital Temperature Controllers User's Manual, Basic Type* (Cat. No. H156).

Setting Temperature Alarms

Alarm Latch

You set a latch for an alarm output. If an alarm latch is enabled, the alarm, once it turns ON, will remain ON regardless of the present temperature until it is cleared by turning OFF the power, pressing the PF Key, or using an event input.

1 Go to the Advanced Function Setting Level.

Refer to page 4-14 for the procedure to enter the Advanced Function Setting Level.

Advanced Function Setting Level

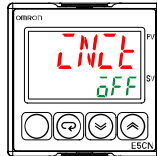

← INIT (INIT) will be displayed to show that the Advanced Function Setting Level has been entered.

2 Change the parameter with the  Key.

Advanced Function Setting Level

Press the  (Mode) Key several times to display A1LT (A1LT).

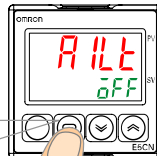



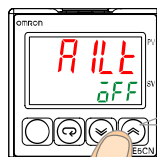

A1LT (A1LT):
← Indicates the Alarm 1 Latch parameter.
← Default setting is OFF (OFF).

3 Set the parameter with the   Keys.

Advanced Function Setting Level



Change between ON and OFF with the   (Up and Down) Keys.

If required, use the  (Mode) Key and the   (Up and Down) Keys to repeat steps 2 and 3 and set ON/OFF for A2LT (A2LT) (Alarm 2 Latch) and A3LT (A3LT) (Alarm 3 Latch).
(The number of alarms that is supported depends on the model of Temperature Controller. Some of the alarm parameters may not be displayed.)

(When finished, press the  (Level) Key for at least 1 second to return to the Initial Setting Level.)

* For details, refer to the E5CN/E5AN/E5EN/E5GN Digital Temperature Controllers User's Manual, Basic Type (Cat. No. H156).

Setting Temperature Alarms

Alarm ON Delay and Alarm OFF Delay

Alarm ON Delay: You can delay the time when the output actually turns ON from when the alarm status turns ON.

Alarm OFF Delay: You can delay the time when the output actually turns OFF from when the alarm status turns OFF.

1

Go to the Advanced Function Setting Level.

Refer to page 4-14 for the procedure to enter the Advanced Function Setting Level.

Advanced Function Setting Level

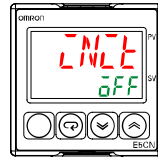

← INIT (INIT) will be displayed to show that the Advanced Function Setting Level has been entered.

2

Change the parameter with the Key.

Advanced Function Setting Level

Press the (Mode) Key several times to display *R1ON* (A1ON).

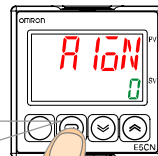

R1ON (A1ON):
← Indicates the Alarm 1 ON Delay parameter.
← Default setting is 0 (0): Delay disabled.

3

Set the parameter with the Keys.

Advanced Function Setting Level

Change the set value with the (Up and Down) Keys.

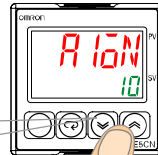

← Alarm 1 ON Delay: 10 seconds (example)

The Alarm OFF Delay parameter follows the Alarm ON Delay parameter.

If required, use the (Mode) Key and the (Up and Down) Keys to repeat steps 2 and 3 and set the ON/OFF delays for *R2ON* (A2ON) (Alarm 2 ON Delay), *R3ON* (A3ON) (Alarm 3 ON Delay), *R1OF* (A1OF) (Alarm 1 OFF Delay), *R2OF* (A2OF) (Alarm 2 OFF Delay), and *R3OF* (A3OF) (Alarm 3 OFF Delay). (The number of alarms that is supported depends on the model of Temperature Controller. Some of the alarm parameters may not be displayed.)

(When finished, press the (Level) Key for at least 1 second to return to the Initial Setting Level.)

* For details, refer to the *E5CN/E5AN/E5EN/E5GN Digital Temperature Controllers User's Manual, Basic Type* (Cat. No. H156).

Setting Temperature Alarms

Alarm Parameter Setting Levels

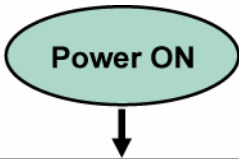

The displays that actually appear depend on the number of alarm outputs supported by the model of Temperature Controller.

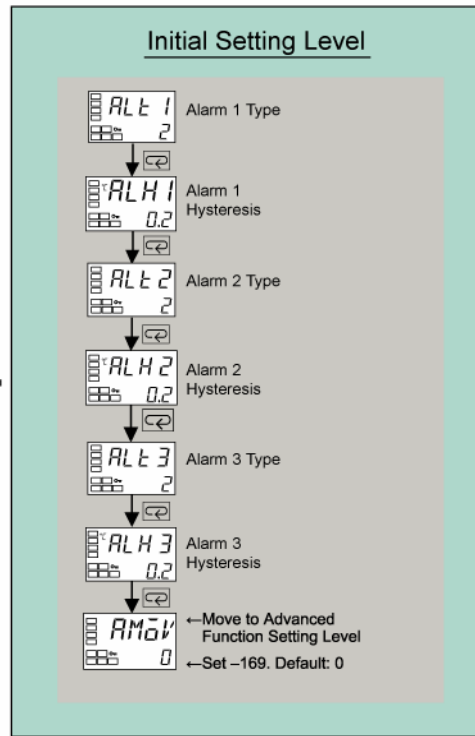
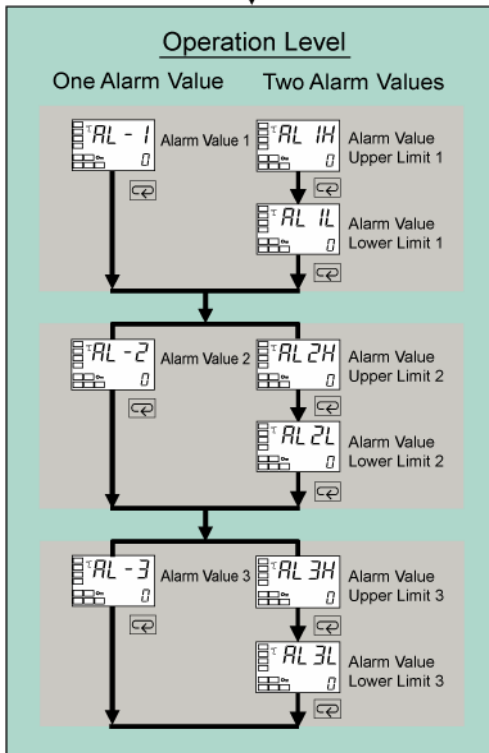

Press Key for at least 3 s.
Control stops.
Press Key for at least 1 s.

Press + Keys for at least 3 s. ↓ ↑ Press + Keys for at least 1 s.

See lower left of page. ↓ ↑ Press Key for at least 1 s.

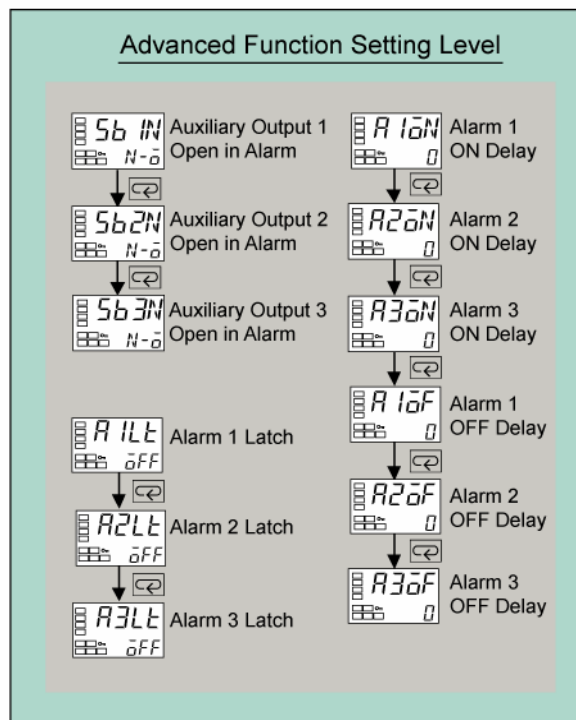
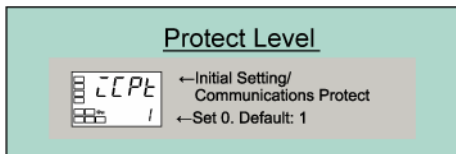

Moving to the Advanced Function Setting Level

1. Move from the Operation Level to the Protect Level.
2. Display the Initial Setting/Communications Protect parameter.
 ←Initial Setting/Communications Protect
←Set 0. Default: 1
3. Change the set value to 0.
4. Move from the Protect Level to the Operation Level to the Initial Setting Level.
5. Display the Move to Advanced Function Setting Level parameter.
 ←Move to Advanced Function Setting Level
←Set -169. Default: 0
6. Set the set value to -169.
7. Enter the Advanced Function Setting Level.
INIT (INIT) will be displayed.

Setting Temperature Alarms

Setting Heater Burnout Alarms

The procedure to output heater burnout alarms is given step by step in this section.

A heater burnout alarm operates by detecting the heater current with a current transformer (CT). If the detected current is less than the specified heater burnout detection current even though the control output is ON, a heater burnout will be assumed and an alarm will be output.

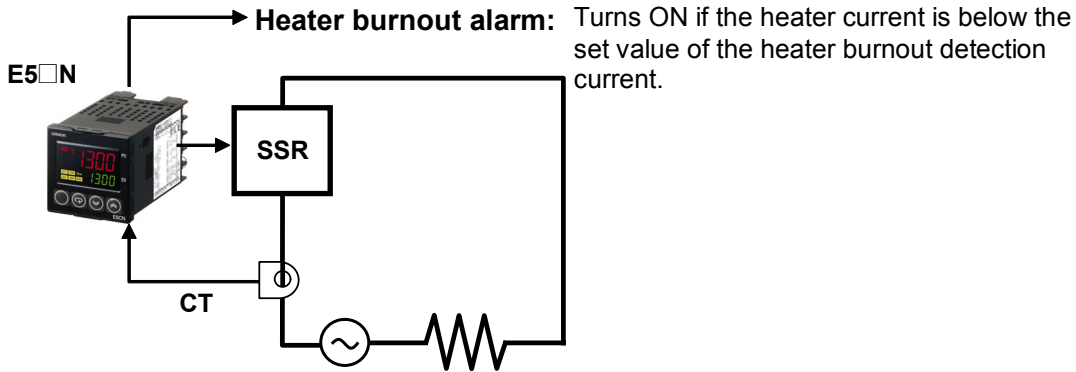

1 Set the Alarm 1 Type parameter to 0.

You can use only alarm 1 for the heater burnout alarm.

To output only the heater burnout alarm from auxiliary output 1, set the alarm type for alarm 1 to 0 (no alarm).

If the alarm type is set to any other value, alarm 1 will turn ON both for the heater burnout alarm and a temperature alarm.

You set this parameter in the Initial Setting Level. The parameter is set to 2 (Upper-limit Alarm) by default.

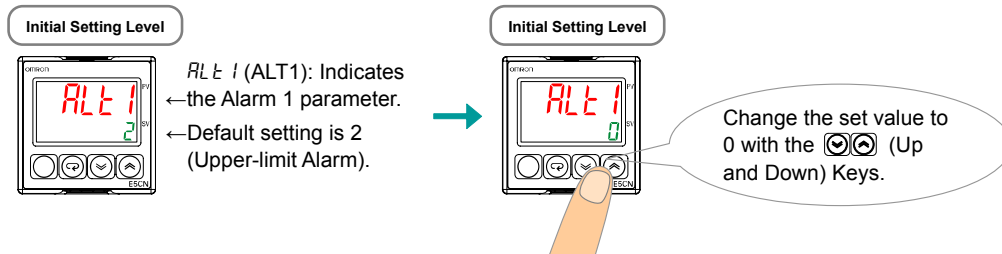

2 Confirm that the heater burnout alarm is enabled.

Confirm that the HB ON/OFF parameter in the Advanced Function Setting Level is set to ON (enabled). The default setting is ON.

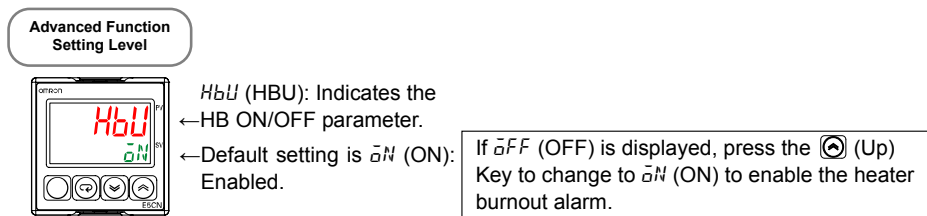

Setting Heater Burnout Alarms

3 Set the heater current to treat as a heater burnout.

Set the Heater Burnout Detection 1 parameter in the Adjustment Level to the heater current to treat as a heater burnout.

You set this parameter in the Adjustment Level. The parameter is set to 0.0 A by default.

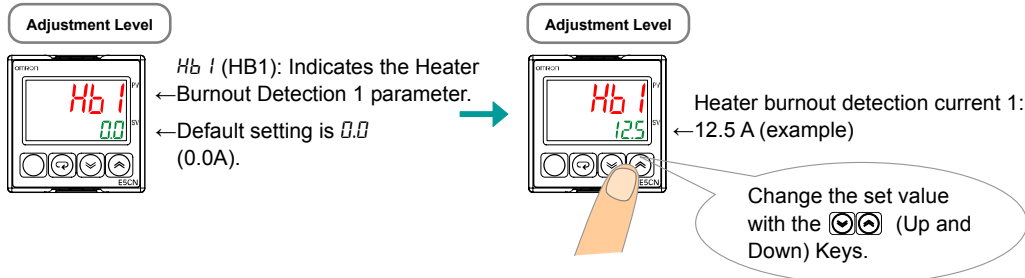

Reference

Calculate the heater burnout detection current as follows:

$$\text{Heater burnout detection current} = \frac{\text{Normal current} + \text{Heater burnout current}}{2}$$

Example: Using Three 200-V, 1-kW Heaters Connected in Parallel

Here, the normal heater current is 15 A, and the heater current for a burnout is 10 A.

$$\begin{aligned} \text{Heater burnout detection current} &= \frac{\text{Normal current } 15 \text{ A} + \text{Heater burnout current}}{2} \\ &= \frac{25\text{A}}{2} = 25 \text{ A}/2 = 12.5 \text{ A} \end{aligned}$$

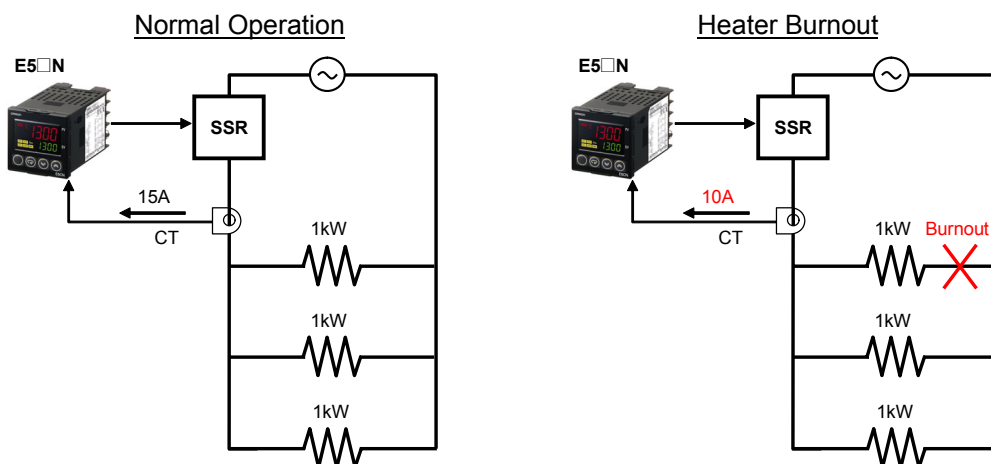

OMRON Corporation Industrial Automation Company

Tokyo, JAPAN

Contact: www.ia.omron.com

Regional Headquarters

OMRON EUROPE B.V.

Wegalaan 67-69-2132 JD Hoofddorp
The Netherlands

Tel: (31)2356-81-300/Fax: (31)2356-81-388

OMRON ELECTRONICS LLC

One Commerce Drive Schaumburg,
IL 60173-5302 U.S.A.

Tel: (1) 847-843-7900/Fax: (1) 847-843-7787

OMRON ASIA PACIFIC PTE. LTD.

No. 438A Alexandra Road # 05-05/08 (Lobby 2),
Alexandra Technopark,
Singapore 119967

Tel: (65) 6835-3011/Fax: (65) 6835-2711

OMRON (CHINA) CO., LTD.

Room 2211, Bank of China Tower,
200 Yin Cheng Zhong Road,
PuDong New Area, Shanghai, 200120, China

Tel: (86) 21-5037-2222/Fax: (86) 21-5037-2200

Authorized Distributor:

© OMRON Corporation 2010 All Rights Reserved.
In the interest of product improvement,
specifications are subject to change without notice.

Cat. No. H168-E1-01A

0411