

SP5000 Series (Display Module) Installation Guide

A decorative graphic consisting of two thick, curved lines that sweep from the bottom left towards the right side of the page. The upper line is dark grey, and the lower line is a lighter shade of grey. They are positioned in the lower half of the page, below the title.

Please read the “Warning/Caution Information” on the attached sheet before using the product.

Safety Information

Important Information	5
-----------------------------	---

Model Numbers

Model Numbers	7
---------------------	---

Overview

Package Contents	8
About the Manual	9
Global Code	9

Part Numbers and Functions

SP-5500TP	10
SP-5600TP/5660TP	11
SP-5700TP	12
SP-5400WA	13
SP-5500WA	14
SP-5600WA	15
LED Indications	16

Specifications

Electrical Specifications	17
Environmental Specifications	19

Installation

Panel Cut Dimensions	20
Installation Requirements	21
Installation Procedure	27
Removal Procedure	32

Wiring

Wiring	35
--------------	----

Front USB Cover

Front USB Cover	42
-----------------------	----

Front USB Port

Front USB Port.....44

Standards

Standards.....47

Important Information

Notice

Read these instructions carefully, and look at the equipment to become familiar with the device before trying to install, operate, or maintain it. The following special messages may appear throughout this documentation or on the equipment to warn of potential hazards or to call attention to information that clarifies or simplifies a procedure.



The addition of this symbol to a "Danger" or "Warning" safety label indicates that an electrical hazard exists which will result in personal injury if the instructions are not followed.



This is the safety alert symbol. It is used to alert you to potential personal injury hazards. Obey all safety messages that follow this symbol to avoid possible injury or death.

DANGER

DANGER indicates a hazardous situation which, if not avoided, **will result in** death or serious injury.

WARNING

WARNING indicates a hazardous situation which, if not avoided, **could result in** death or serious injury.

CAUTION

CAUTION indicates a hazardous situation which, if not avoided, **could result in** minor or moderate injury.

NOTICE

NOTICE is used to address practices not related to physical injury.

PLEASE NOTE

Electrical equipment should be installed, operated, serviced, and maintained only by qualified personnel. No responsibility is assumed by Pro-face for any consequences arising out of the use of this material.

A qualified person is one who has skills and knowledge related to the construction and operation of electrical equipment and its installation, and has received safety training to recognize and avoid the hazards involved.

Model Numbers

Series		Model name	Model number
SP5000 Series	Premium Display	SP-5500TP	PFXSP5500TPD
		SP-5600TP	PFXSP5600TPD
		SP-5660TP	PFXSP5660TPD
		SP-5700TP	PFXSP5700TPD
	Advanced Display	SP-5400WA	PFXSP5400WAD
		SP-5500WA	PFXSP5500WAD
SP-5600WA		PFXSP5600WAD	

NOTE: These models can be connected to all models of SP5000 Series Box Module. For the model numbers of the Box Module, refer to Model Names in the SP5000 Series (Box Module) Installation Guide.

Package Contents

The following items are included in the package. Before using this product, please confirm that all items listed here are present.

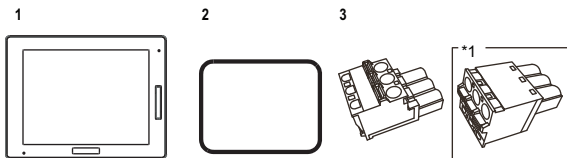

- 1 SP5000 Series Display Module: 1
- 2 Installation gasket: 1 (attached to this product)
- 3 DC power supply connector (right-angle type^{*1}): 1
- 4 SP5000 Series (Display Module) Installation Guide (this guide): 1
- 5 Warning/Caution Information: 1

*1 Straight type for SP-5400WA

This product has been carefully packed, with special attention to quality. However, should you find anything damaged or missing, please contact your local distributor immediately.

About the Manual

This manual describes wiring and installation procedures. For more detailed information, refer to the SP5000 Series Hardware Manual.

You can download the manual from our website "Otasuke Pro!" at <http://www.pro-face.com/otasuke>.

Global Code

A global code is assigned to every Pro-face product as a universal model number.

For more information on product models and their matching global codes, please refer to the following URL.

<http://www.pro-face.com/product/globalcode.html>

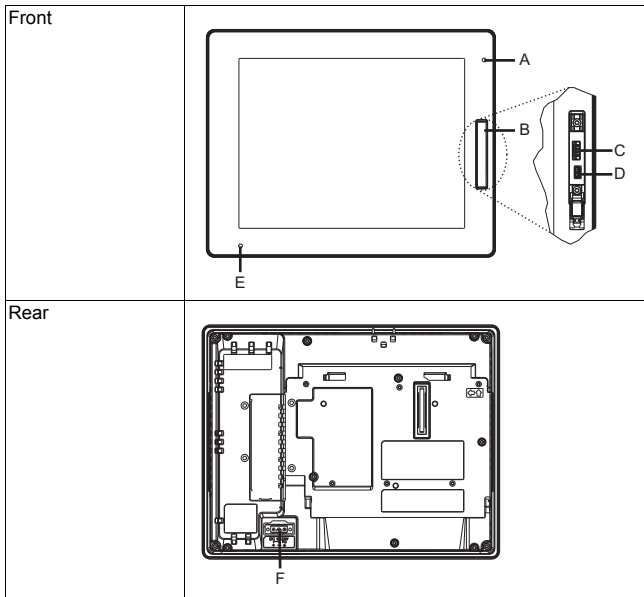
SP-5500TP

- A: Brightness sensor
- B: Front USB cover
- C: USB (Type A) interface
- D: USB (mini-B) interface
- E: Status LED (see page 16)
- F: Power plug connector

SP-5600TP/5660TP

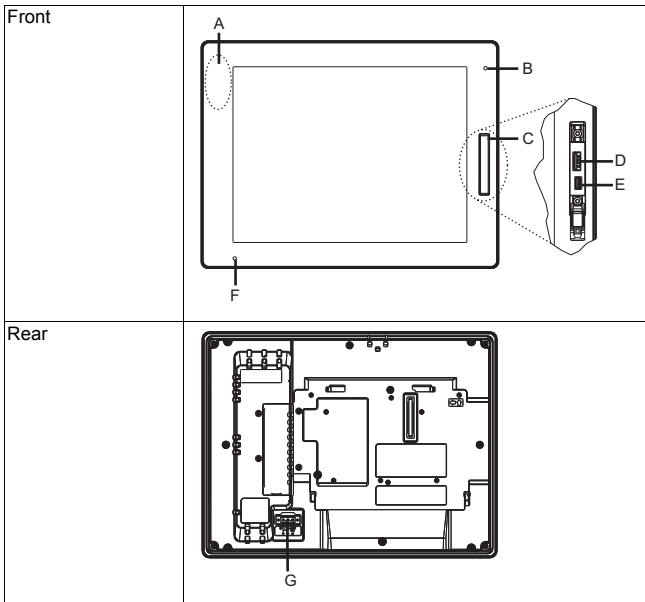

- A: Wireless LAN antenna (only for SP-5660TP)
- B: Brightness sensor
- C: Front USB Cover
- D: USB (Type A) interface
- E: USB (mini-B) interface
- F: Status LED (see page 16)
- G: Power plug connector

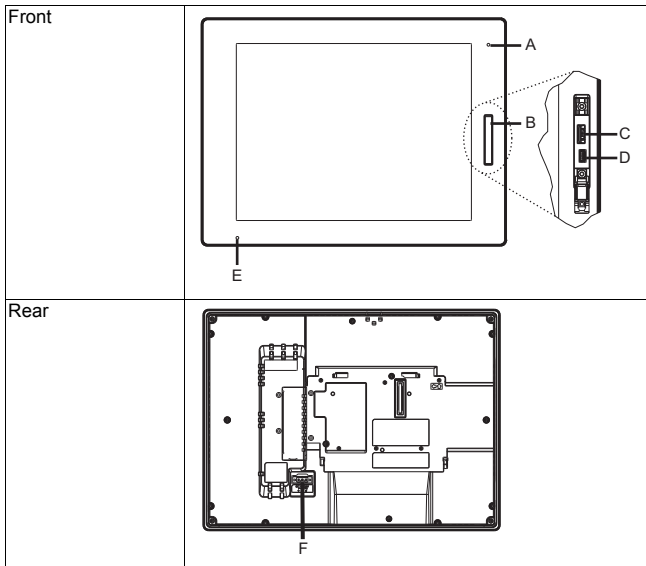
SP-5700TP

- A: Brightness sensor
- B: Front USB cover
- C: USB (Type A) interface
- D: USB (mini-B) interface
- E: Status LED (see page 16)
- F: Power plug connector

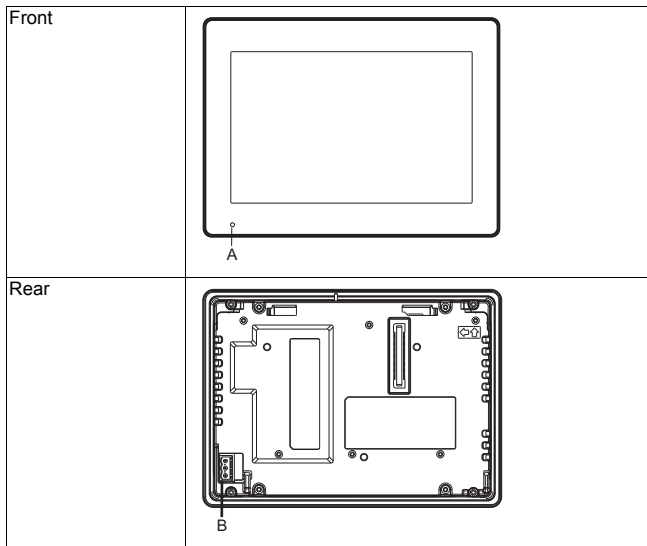
SP-5400WA

A: Status LED (see page 16)

B: Power plug connector

SP-5500WA

Front

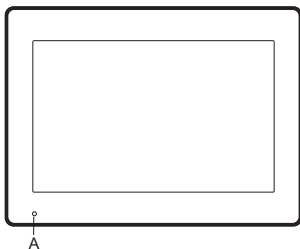

Rear

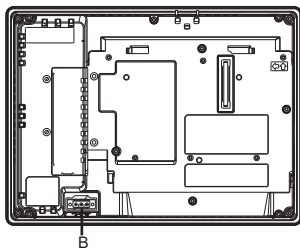

A: Status LED (see page 16)

B: Power plug connector

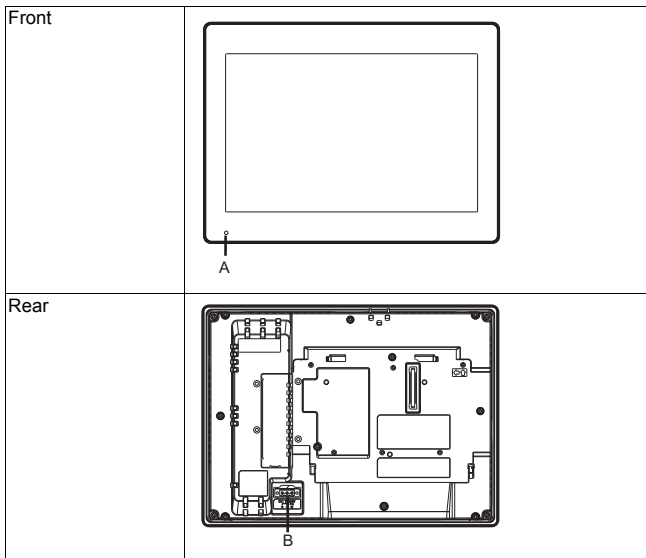
SP-5600WA

A: Status LED (see page 16)

B: Power plug connector

LED Indications

Status LED

Color	Indicator	Connected to SP-5B10		Connected to SP-5B40	
		HMI Operation	Logic Program Operation* ¹	HMI Operation	Logic Program Operation* ¹
Green	ON	Offline	–	Offline	–
		In operation	RUN	In operation	RUN
	Flashing	In operation	STOP	In operation	STOP
	LED fade	Backlight OFF (Standby Mode)			
Orange	Flashing	Software starting up.			
Red	ON	Power is turned ON.			
	Flashing	In operation	Major error	In operation	Major error
Red/ Green	Alternating	Box Module connection error			
Orange/ Red	Alternating	SD Card boot error		–	
Orange/ Red/ Green	Alternating	Display Module connection error			
–	OFF	Power is turned OFF.			

*1 Only when your screen editing software supports the Logic Program.

NOTE: When the SP-5B40 is connected, even if its operating system is shut down, the status LED on the Display Module will display red if connected to a power supply.

Electrical Specifications

SP-5500TP/5600TP/5660TP/5700TP

Specification		SP-5500TP	SP-5600TP	SP-5660TP	SP-5700TP	
Power supply	Rated input voltage	12...24 Vdc				
	Input voltage limits	10.8...28.8 Vdc				
	Voltage drop	12 Vdc: 1.25 ms or less 24 Vdc: 5 ms or less				
	Power consumption (primary power supply including power loss)	Max (including Box Module)	50 W	56 W	58 W	57 W
		Max (Display Module only)* ¹	15 W	21 W	23 W	22 W
		When power is not supplied to external devices (Display Module only)* ¹	12 W or less	18 W or less	20 W or less	19 W or less
		When screen turns off the backlight (Stand-by Mode) (Display Module only)* ¹	6 W or less		8 W or less	6 W or less
		When screen backlight 20% (Display Module only)* ¹	8 W or less	11 W or less	13 W or less	11 W or less
In-rush current	30 A or less					
Voltage endurance	1,000 Vac, 20 mA for 1 min. (between charging and FG terminals)					
Insulation resistance	500 Vdc, 10 MΩ or more (between charging and FG terminals)					

*1 The power consumption for the combined unit of Box Module and Display Module equals the sum of the power consumption for the Modules.

SP-5400WA/5500WA/5600WA

Specification		SP-5400WA	SP-5500WA	SP-5600WA	
Power supply	Rated input voltage	12...24 Vdc			
	Input voltage limits	10.8...28.8 Vdc			
	Voltage drop	12 Vdc: 1.25 ms or less 24 Vdc: 5 ms or less			
	Power consumption (primary power supply including power loss)	Max (including Box Module)	41 W	43 W	45 W
		Max (Display Module only) ^{*1}	6.5 W	8.5 W	11.5 W
		When power is not supplied to external devices (Display Module only) ^{*1}	-		
		When screen turns off the backlight (Stand-by Mode) (Display Module only) ^{*1}	2 W or less	2.5 W or less	2.5 W or less
	When screen backlight 20% (Display Module only) ^{*1}	4 W or less	5 W or less	6 W or less	
In-rush current	30 A or less				
Voltage endurance	1,000 Vac, 20 A for 1 min. (between charging and FG terminals)				
Insulation resistance	500 Vdc, 10 MΩ or more (between charging and FG terminals)				

*1 The power consumption for the combined unit of Box Module and Display Module equals the sum of the power consumption for each of the Modules.

Environmental Specifications

Physical environment	Surrounding air temperature	0...60 °C (32...140 °F)
	Storage temperature	-20...60 °C (-4...140 °F)
	Surrounding air and storage humidity	10...90% RH (non-condensing, wet bulb temperature 39 °C [102.2 °F] or less)
	Dust	0.1 mg/m ³ (10 ⁻⁷ oz/ft ³) or less (non-conductive levels)
	Pollution degree	For use in Pollution Degree 2 environment

Panel Cut Dimensions

Based on the panel cut dimensions, open a mount hole on the panel.

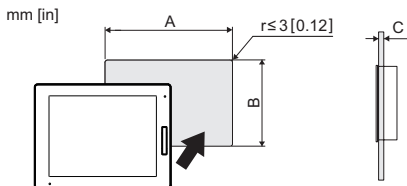

Model name	A	B	C
SP-5500TP	259 ⁺¹ ₋₀ mm (10.2 ^{+0.04} ₋₀ in)	201 ⁺¹ ₋₀ mm (7.91 ^{+0.04} ₋₀ in)	1.6... 5 mm (0.06... 0.2 in)
SP-5600TP/ 5660TP	301.5 ⁺¹ ₋₀ mm (11.87 ^{+0.04} ₋₀ in)	227.5 ⁺¹ ₋₀ mm (8.96 ^{+0.04} ₋₀ in)	
SP-5700TP	383.5 ⁺¹ ₋₀ mm (15.1 ^{+0.04} ₋₀ in)	282.5 ⁺¹ ₋₀ mm (11.12 ^{+0.04} ₋₀ in)	
SP-5400WA	190 ⁺¹ ₋₀ mm (7.48 ^{+0.04} ₋₀ in)	135 ⁺¹ ₋₀ mm (5.31 ^{+0.04} ₋₀ in)	
SP-5500WA	255 ⁺¹ ₋₀ mm (10.04 ^{+0.04} ₋₀ in)	185 ⁺¹ ₋₀ mm (7.28 ^{+0.04} ₋₀ in)	
SP-5600WA	295 ⁺¹ ₋₀ mm (11.61 ^{+0.04} ₋₀ in)	217 ⁺¹ ₋₀ mm (8.54 ^{+0.04} ₋₀ in)	

Installation Requirements

This product is designed for use on flat surfaces of Type 1, Type 4X (Indoor Use Only) or Type 13 Enclosure.

Mount this product in an enclosure that provides a clean, dry, robust and controlled environment (IP65F^{*1}, IP66F^{*1}, IP67F^{*1}, Type 1, Type 4X [Indoor Use Only], or Type 13 Enclosure).

For Advanced Display, the front surface is IP66F^{*1}, IP67F^{*1}, Type 1, Type 4X (Indoor Use Only) or Type 13 Enclosure.

For Premium Display, when using a factory-installed front USB cover (without screw), the front surface is IP65F^{*1}, IP67F^{*1} or Type 1 Enclosure. When using a front USB cover (with screw^{*2}) manufactured by Pro-face (Model Number PFXZCDCVUS1), the front surface is IP66F^{*1}, IP67F^{*1}, Type 1, Type 4X (Indoor Use Only) or Type 13 Enclosure.

Display front surface			Enclosure front surface
Premium Display		Advanced Display	
Without screw	With screw		
IP65F, IP67F, Type 1	IP66F, IP67F, Type 1, Type 4X (Indoor Use Only), Type 13	IP66F, IP67F, Type 1, Type 4X (Indoor Use Only), Type 13	IP65F, IP66F, IP67F, Type 1, Type 4X (Indoor Use Only), Type 13

For Premium Display, regardless of using a factory-installed front USB cover or a front USB cover with screw, when the cover is open, the front surface is Type 1 Enclosure.

- Be aware of the following when building this product into an end-use product:
- The rear face of this product is not approved as an enclosure. When building this product into an end-use product, be sure to use an enclosure that satisfies standards as the end-use product's overall enclosure.
 - This product must be used indoors only.
 - Install and operate this product with its front panel facing outward.

*1 IP65F, IP66F and IP67F are not part of the UL certification.

*2 The necessary torque is 0.5 N•m (4.4 lb-in).

⚠ CAUTION

RISK OF BURNING INJURY

Do not touch a heat sink during operation.

Failure to follow these instructions can result in injury or equipment damage.

Check that the installation wall or cabinet surface is flat, in good condition and has no jagged edges. Metal reinforcing strips may be attached to the inside of the wall, near the panel-cut, to increase its rigidity.

Decide on the thickness of the enclosure wall, based on the level of strength required: 1.6...5 mm (0.06...0.2 in).

Even if the installation wall thickness is within the recommended range for the panel cut dimensions, depending on wall's material, size, and installation location of this product and other devices, the installation wall could warp. To prevent warping, the installation surface may need to be strengthened.

Be sure that the surrounding air temperature and the ambient humidity are within their designated ranges. Surrounding air temperature: 0 to 60 °C (32 to 140 °F) (see the Environment Specifications for this product); ambient humidity: 10 to 90% RH; wet bulb temperature: maximum 39 °C (102 °F). When installing this product in a cabinet or enclosure, the surrounding air temperature is the cabinet's or enclosure's internal temperature.

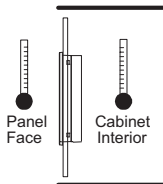

Be sure that heat from surrounding equipment does not cause this product to exceed its standard operating temperature.

When mounting this product vertically, ensure that the right side of this product faces up. In other words, the DC power connector should be at the top.

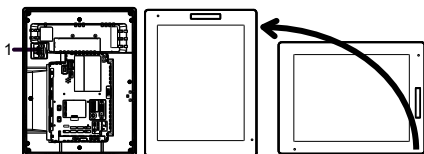

1 Power connector

When installing this product in a slanted position, the product face should not incline more than 30° .

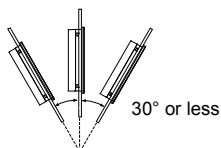

When installing this product in a slanted position with an incline more than 30° , the ambient temperature must not exceed 40°C (104°F). You may need to use forced air cooling (fan, A/C) to ensure the ambient operating temperature is 40°C or less (104°F or less).

Installation

For easier maintenance, operation and improved ventilation, install this product at least 100 mm (3.94 in) away from adjacent structures and other equipment as shown in the following illustration:

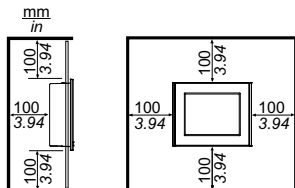

Please ensure you have enough space to insert and remove the storage card.

For Wireless LAN models, do not block the wireless LAN antenna area with your hand, body or other objects. It may cause interference in wireless LAN communications.

Wireless LAN Models

WARNING

ELECTROMAGNETIC/RADIO INTERFERENCE

If you are uncertain of the policy that applies to the use of the Wireless LAN model, ask the administrator about its use before you turn it on.

Failure to follow these instructions can result in death, serious injury, or equipment damage.

2.4 GHz Wireless Devices

The Wireless LAN model uses the 2.4 GHz frequency range, which is used by a wide range of wireless equipment. Example usage includes industrial, scientific, and medical equipment such as microwave ovens, on-site wireless stations (requiring licenses), low-power wireless stations (not requiring licenses) as well as amateur wireless stations (requiring licenses).

1. Before use, confirm that no on-site wireless stations and specified low-power wireless stations or amateur wireless stations operate in your vicinity.
2. In the event that the Wireless LAN model causes harmful interference to any other "on-site wireless stations", immediately change the channel frequency of the Wireless LAN model, or change its location, or halt operation of radio emissions and contact the administrator of the wireless network to resolve the issue.

Security on Your Wireless LAN

Because wireless LANs do not normally provide adequate data security, the following problems may occur.

1. Unlawful access of communication information.
 - There is a chance that information found in emails, and personal information such as user IDs, passwords, and credit card numbers, may be intentionally intercepted by a malicious third party.
2. Illegal access

A malicious third party may be able to access personal or company data over the company's local area network without permission, to:

 - Obtain personal and confidential information (information leak)
 - Impersonate someone by communicating as that person and disseminating invalid information (spoofing)

- Alter intercepted communications and re-transmitting tolerated content (falsification)
- Cause critical damage to data and or systems due to a computer virus (damage).

This wireless LAN product includes security features that enable you to configure security-related settings that reduce the likelihood of the above-mentioned problems.

We recommend that you make yourself fully acquainted with the possible implications of what might happen if you use a wireless product without enabling security features, and that you configure security-related settings and use wireless products at your own responsibility.

Installation Procedure

Installing to the Panel

DANGER

HAZARD OF ELECTRIC SHOCK, EXPLOSION OR ARC FLASH

- Remove all power from the device before removing any covers or elements of the system, and prior to installing or removing any accessories, hardware, or cables.
- Unplug the power cable from both the Display Module and the power supply.
- Always use a properly rated voltage sensing device to confirm power is off.
- Replace and secure all covers or elements of the system before applying power to the Display Module.

Failure to follow these instructions will result in death or serious injury.

NOTICE

EQUIPMENT DAMAGE

- When mounting this product vertically, first install the Box Module onto the Display Module before attaching the Display Module to the panel.
- Keep this product stabilized in the panel-cut while you are installing or removing the screw fasteners.

Failure to follow these instructions can result in equipment damage.

Step	Action
1	<p>When mounting this product vertically, place the Display Module on a clean and level surface with the screen facing down and mount the Box Module to the Display Module.</p> <p>NOTE: Refer to the SP5000 Series Hardware Manual or SP5000 Series (Box Module) Installation Guide on how to mount the Box Module to the Display Module.</p>

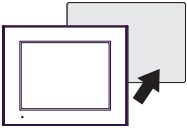
2	<p>Check that the Display Module's gasket is seated securely into the gasket's groove, which runs around the perimeter of the display panel frame.</p> <p>NOTE: Always use the installation gasket, since it absorbs vibration in addition to repelling water. For the procedure on replacing the installation gasket, refer to SP5000 Series Hardware Manual.</p>
3	<p>Based on the Display Module's panel cut dimensions (see page 20), open a mount-hole on the panel and attach the Display Module to the panel from the front side.</p>  <p>The diagram illustrates the installation of a gasket into a display panel. It shows a square display panel with a double-line border representing a groove. A grey rectangular gasket is positioned behind the panel, and a black arrow points to the right, indicating the direction of insertion into the groove.</p>

- 4 Confirm that the anti-drop lock on the top of the Display Module is attached to the panel.

Except for SP-5400WA

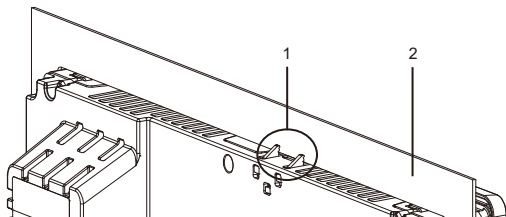

SP-5400WA

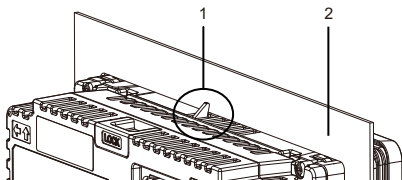

1 Anti-drop lock
2 Panel

- 5 Using a Phillips screwdriver, gradually tighten (turn clockwise) the screws for the fasteners (top, bottom, left, and right), alternating diagonally between screws until all are secure. Be sure that the L-shaped part of the installation fastener (2 in figure below) is completely vertical. The necessary torque is 0.5 N•m (4.4 lb-in).

NOTE:

- If the Display Module is not mounted properly, it may fall.
- If the panel is thick (approx. 5 mm [0.2 in]), you may have trouble straightening the L-shaped part of the installation fastener. If this happens, push the Display Module from the front as you tighten the screws.

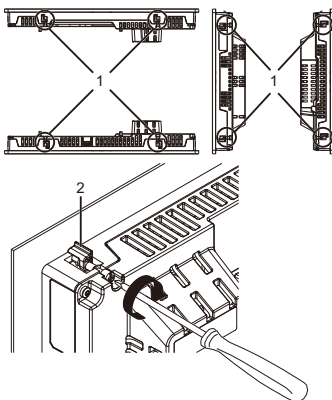

1 Installation fastener

2 L-shaped part of the Installation fastener

Number of Installation Fasteners

	Top	Bottom	Right	Left
15-inch models	2	2	2	2
Models less than 12-inch	2	2	—	—

NOTICE

BROKEN ENCLOSURE

Do not exert more than 0.5 N•m (4.4 lb-in) of torque when tightening the fastener's screws.

Failure to follow these instructions can result in equipment damage.

Removal Procedure

Removing from the Panel



HAZARD OF ELECTRIC SHOCK, EXPLOSION OR ARC FLASH

- Remove all power from the device before removing any covers or elements of the system, and prior to installing or removing any accessories, hardware, or cables.
- Unplug the power cable from both the Display Module and the power supply.
- Always use a properly rated voltage sensing device to confirm power is off.
- Replace and secure all covers or elements of the system before applying power to this product.

Failure to follow these instructions will result in death or serious injury.

NOTICE

EQUIPMENT DAMAGE

- When this product is mounted vertically, first remove the Display Module from the panel, then remove the Box Module from the Display Module.
- Keep this product stabilized in the panel-cut while you are installing or removing the screw fasteners.

Failure to follow these instructions can result in equipment damage.

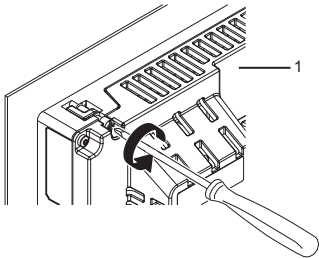
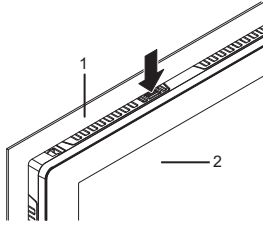
Step	Action
1	<p>Using a Phillips screwdriver, gradually loosen (turn counterclockwise) the screws for the fasteners (top, bottom, left, and right), alternating diagonally between screws until all screws are loose.</p>  <p>1 Rear side</p> <p>NOTE:</p> <ul style="list-style-type: none"> • For the number of installation fasteners on your model, see Number of Installation Fasteners in Step 5 of Installing to the Panel (see page 30). • If the panel is thick (approx. 5 mm [0.2 in]), you may have trouble straightening the L-shaped part of the installation fastener. If this happens, push the display module from the front as you loosen the screws.
2	<p>While pushing on the anti-drop lock on the top of the Display Module with a tool such as a screwdriver, slowly remove the Display Module from the panel.</p>  <p>1 Panel 2 Front side</p>

CAUTION

RISK OF INJURY

Do not drop this product when you remove it from the panel.

- Hold this product in place after removing the fasteners.
- Use both hands.
- While pushing on the anti-drop lock, be careful not to hurt your fingers.

Failure to follow these instructions can result in injury or equipment damage.

NOTICE

EQUIPMENT DAMAGE

To avoid damage, remove this product while pushing the anti-drop lock or by making sure the lock does not touch the panel.

Failure to follow these instructions can result in equipment damage.

Wiring

DANGER

HAZARD OF ELECTRIC SHOCK, EXPLOSION OR ARC FLASH

- Remove all power from the device before removing any covers or elements of the system, and prior to installing or removing any accessories, hardware, or cables.
- Remove power before wiring this product's power terminals.
- Always use a properly rated voltage sensing device to confirm power is off.
- Replace and secure all covers or elements of the system before applying power to this product.
- This product uses only 12 to 24 Vdc power. Using any other level of power can damage both the power supply and this product.
- Since this product is not equipped with a power switch, be sure to connect a power switch to the power supply.
- Be sure to ground this product's FG terminal.

Failure to follow these instructions will result in death or serious injury.

NOTE:

- The SG (signal ground) and FG (functional ground) terminals are connected internally in this product.
- When the FG terminal is connected, be sure the wire is grounded. Not grounding this product can result in excessive electromagnetic interference (EMI).

DC Power Cord Preparation

- Make sure the ground wire is either the same or heavier gauge than the power wires.
- Do not use aluminum wires in the power supply's power cord.
- To prevent the possibility of a terminal short, use a pin terminal that has an insulating sleeve.
- If the ends of the individual wires are not twisted correctly, the wires may create a short circuit.
- The conductor type is solid or stranded wire.
- Use copper wire rated for 75 °C (167°F).

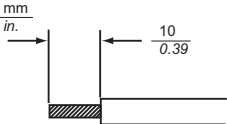
Power cord diameter	0.75...2.5 mm ² (18...13 AWG) ^{*1}
Conductor type	Solid or stranded wire
Conductor length	
Recommended driver ^{*2}	SZS 0.6 x 3.5 (1205053)
Recommended pin terminals ^{*2}	3201288 Al 0,75 - 10 GY 3200182 Al 1 - 10 RD 3200195 Al 1,5 - 10 BK 3202533 Al 2,5 - 10 BU
Recommended pin terminal crimp tool ^{*2}	CRIMPFOX6

*1 For UL compatibility, use AWG14 or AWG13.

*2 Items are made by Phoenix Contact.

Power Connector Specifications: Spring Clamp Terminal Blocks

Models except for SP-5400WA come with the right-angle type power connector, and the SP-5400WA comes with the straight type power connector.

Right-angle type

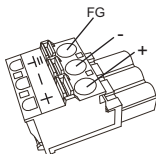

Straight type

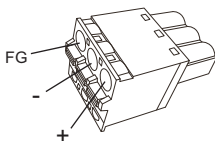

Connection	Wire
+	12...24 Vdc
-	0 Vdc
FG	Grounded terminal connected to the panel chassis.

NOTE:

- You cannot connect the right-angle type to the SP-5400WA.
- Right-angle type: PFXZCBCNDC2 manufactured by Pro-face
Straight type: PFXZCBCNDC1 manufactured by Pro-face

How to Connect the DC Power Cord

Step	Action
1	Confirm the power cord is not connected to the power supply.
2	Check the rated voltage, and remove the "DC24V" sticker on the DC power supply connector.
3	Connect each wire from the power cable to a pin terminal.
4	Push the Opening button with a small and flat screwdriver to open the desired pin hole.
5	Insert each power cord wire into its corresponding holder. Release the Opening button to clamp the wire in place. <div style="text-align: center; margin: 10px 0;"> <p style="margin: 0;">DC Power Cord Opening Button</p> <p style="margin: 0; margin-left: 100px;">+ (12...24 Vdc)</p> <p style="margin: 0; margin-left: 100px;">- (0 Vdc)</p> <p style="margin: 0; margin-left: 100px;">FG</p> </div> <p>When using stranded wire, do not short with neighboring wires.</p>
6	After inserting all three power cord wires, insert the DC power supply connector into the power connector on this product.

NOTE: Do not solder the wire directly to the power crimp pin

Wiring Precautions

Excessive stress on the power connection or attempting to install this product with the power cables connected may disconnect or cause damage to the power connections. This can cause short circuits, fire or unintended equipment operation.



SHORT CIRCUIT, FIRE, OR UNINTENDED EQUIPMENT OPERATION

Avoid excessive force on the power cable to prevent accidental disconnection

- Securely attach power cables to an installation panel or cabinet.
- Use the necessary torque to tighten this product terminal block screws.
- Install and fasten this product on installation panel or cabinet prior to connecting power supply and communication lines.

Failure to follow these instructions will result in death or serious injury.

Improving Noise/Surge Resistance

- This product's power supply cord should not be bundled with or kept close to main circuit lines (high voltage, high current), power lines, or input/output lines, and their various systems should be kept separate. When power lines cannot be wired via a separate system, use shielded cables for input/output lines.
- Make the power cord as short as possible, and be sure to twist the ends of the wires together (i.e. twisted pair cabling) from close to the power supply unit.
- If there is an excess amount of noise on the power supply line, connect a noise reducing transistor before turning on the power.
- Connect a lightning surge absorber to handle power surges.
- To increase noise resistance, attach a ferrite core to the power cable.

Grounding

- Check that the grounding resistance is $100\ \Omega$ or less.*1
- The FG wire should have a cross sectional area greater than $2\ \text{mm}^2$ (AWG14)*1. Create the connection point as close to this product as possible, and make the wire as short as possible. When using a long grounding wire, replace the thin wire with a thicker wire, and place it in a duct.

*1 Observe local codes and standards.

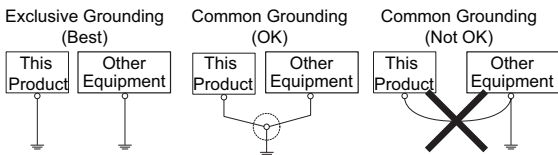

Short Circuit Prevention

- The SG (signal ground) and FG (functional ground) terminals are connected internally in this product. When connecting the SG line to another device, be sure that no shorting loops are formed.

Front USB Cover

For Premium Display, when using a factory-installed front USB cover (without screw), the front surface is IP65F¹, IP67F¹ or Type 1 Enclosure. When using a front USB cover (with screw²) manufactured by Pro-face (Model Number PFXZCDCVUS1), the front surface is IP66F¹, IP67F¹, Type 1, Type 4X (Indoor Use Only) or Type 13 Enclosure.

NOTE: Advanced Display does not have a front USB port.

Regardless of using a factory-installed front USB cover or a front USB cover with screw, when the cover is open, the front surface is Type 1 Enclosure.

⚠ CAUTION

RISK OF INJURY

When opening the front USB cover, be careful not to injure your fingers.

Failure to follow these instructions can result in injury or equipment damage.

*1 IP65F, IP66F and IP67F are not part of the UL certification.

*2 The necessary torque is 0.5 N•m (4.4 lb-in).

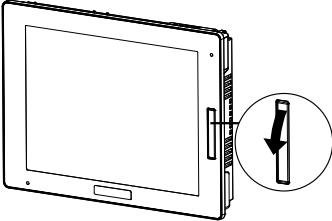
Step	Action
1	<p>Place your finger or a tool such as a screwdriver in the gap on the top of the front USB cover and pull down as illustrated.</p>  <p>NOTE:</p> <ul style="list-style-type: none"> • When using the front USB cover manufactured by Pro-face (Model Number PFXZCDCVUS1), loosen the top screw using a Phillips screwdriver. • The necessary torque is 0.5 N•m (4.4 lb-in).

- 2 The USB interface can be seen once you pull down the front USB cover.

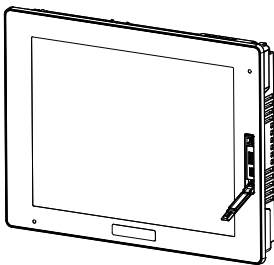

NOTICE

BROKEN ENCLOSURE

Do not exert more than 0.5 N•m (4.4 lb-in) of torque when tightening the screw.

Failure to follow these instructions can result in equipment damage.

Front USB Port

USB Connections

Non-incendive field wiring apparatus (keyboards, mouse) are permitted for use on front USB port (Type A) of associated field wiring non-incendive Apparatus (this product). Non-incendive field wiring apparatus (this product) are permitted for use on front USB port (mini-B) of associated field wiring non-incendive apparatus (Computer)

In addition to being non-incendive, any equipment connected to the front USB ports must satisfy the following criteria.

The following figures show the USB cable wiring:

<Type A>

Associated Non-incendive
Field Wiring Apparatus

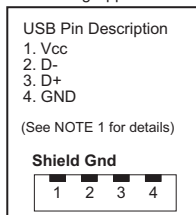

Class I, Division 2 Groups A, B,
C, D, or non-hazardous location

Non-incendive Field
Wiring Apparatus

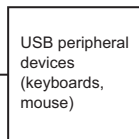

Class I, Division 2
Groups A, B, C, D

USB Cable

Circuit parameters	Front USB (Type A)
Open-circuit voltage = V_{oc}	5.25 V
Short-circuit current = I_{sc}	1300 mA
Associated capacitance = C_a	265 μ F
Associated inductance = L_a	16 μ H

<mini-B>

Non-incendive
Field Wiring Apparatus

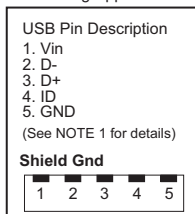

Class I, Division 2
Groups A, B, C, D

Associated Non-incendive
Field Wiring Apparatus

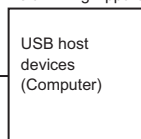

Class I, Division 2
Groups A, B, C, D
or non-hazardous location

USB Cable

Circuit parameters	Front USB (mini-B)
Maximum input voltage = V_{\max}	5.25 V
Maximum load current = I_{\max}	0.1 mA
Internal capacitance = C_i	0.24 μ F
Internal inductance = L_i	16 μ H

NOTE:

1. The above tables list the Non-incendive Circuit Parameters.

The Entity Concept allows interconnection of non-incendive apparatus with associated apparatus – not specifically examined combinations – as a system when the approved values of V_{oc} (or U_o) and I_{sc} (or I_o) for the associated apparatus are less than or equal to V_{\max} (U_i) and I_{\max} (I_i) for the non-incendive apparatus, and the approved values of C_a (C_o) and L_a (L_o) for the associated apparatus are greater than or equal to $C_i + C_{\text{cable}}$ and $L_i + L_{\text{cable}}$, respectively, for the non-incendive field wiring apparatus.

2. Associated non-incendive field wiring apparatus and non-incendive field wiring apparatus shall satisfy the following:

Associated non-incendive field wiring apparatus	-	Non-incendive field wiring apparatus
V_{oc}	\leq	V_{\max}
I_{sc}	\leq	I_{\max}
C_a	\geq	$C_i + C_{\text{cable}}$
L_a	\geq	$L_i + L_{\text{cable}}$

Front USB Port

3. If the electrical parameters of the cable are unknown, the following values may be used:

$$C_{\text{cable}} = 196.85 \text{ pF/m (60 pF/ft)}$$

$$L_{\text{cable}} = 0.656 \text{ }\mu\text{H/m (0.20 }\mu\text{H/ft)}$$

4. Wiring methods must be in accordance with the electrical code of the country where it is used.

This product must be installed in an enclosure. If installed in a Class I, Division 2 Location, the enclosure must be capable of accepting one or more Division 2 wiring methods.

DANGER

POTENTIAL FOR EXPLOSION

- Verify that the power, input and output (I/O) wiring are in accordance with Class I, Division 2 wiring methods.
- Substitution of any component may impair suitability for Class I, Division 2.
- Do not disconnect equipment while the circuit is live or unless the area is known to be free of ignitable concentrations.
- Remove power before attaching or detaching any connectors to or from this product.
- Ensure that power, communication, and accessory connections do not place excessive stress on the ports. Consider the vibration in the environment when making this determination.
- Securely attach power, communication, and external accessory cables to the panel or cabinet.
- Use only commercially available USB cables.
- Use only non-incendive USB configurations.
- The associated non-incendive field wiring apparatus shall not be connected in parallel unless approved by the associated non-incendive apparatus.
- This product is suitable for use and provides non-incendive field wiring to apparatus in Class I, Division 2, Groups A, B, C, D Hazardous Locations.

Failure to follow these instructions will result in death or serious injury.

Standards

For information on certifications and standards, such as certified models and certificates, see the product markings or the following URL:

<http://www.pro-face.com/worldwide.html>

DANGER

POTENTIAL FOR EXPLOSION

- Suitable for use in Class I, Division 2, Groups A, B, C, and D Hazardous Locations.
- Substitution of any component may impair suitability for Class I, Division 2.
- Do not disconnect equipment while the circuit is live or unless power the area is known to be free of ignitable concentrations.
- Always confirm that this product is suitable for use in hazardous locations by checking that the ANSI/ISA 12.12.01 and CSA C22.2 N°213 certification appears on the product labeling.
- Do not attempt to install, operate, modify, maintain, service, or otherwise alter this product except as permitted in this manual. Unpermitted actions may impair the suitability of this product for Class I, Division 2 operation.
- To power on or power off this product installed in a Class I, Division 2 hazardous location, you must either:
 - Use a switch located outside the hazardous environment, or
 - Use a switch certified for Class I, Division 1 operation inside the hazardous area.
- Do not disconnect equipment unless power has been switched off or the area is known to be non-hazardous. This applies to all connections including power, ground, serial, parallel, and network connections.
- Never use unshielded / ungrounded cables in hazardous locations.
- When enclosed, keep enclosure doors and openings closed at all times to avoid the accumulation of foreign matter inside the workstation.

Failure to follow these instructions will result in death or serious injury.

Inquiry

Do you have any questions about difficulties with your unit?
Please access our site any time that you need help with a solution.

<http://www.pro-face.com/otasuke/>

Note

Please be aware that Digital Electronics Corporation shall not be held liable by the user for any damages, losses, or third party claims arising from the uses of this product.

Wireless LAN Information

USA

SP-5660TP contains Transmitter Module FCC ID: N6C-SDMGN

FCC CAUTION

Changes or modifications not expressly approved by the party responsible for compliance could void the user's authority to operate the equipment.

NOTE: This equipment has been tested and found to comply with the limits for a Class A digital device, pursuant to part 15 of the FCC Rules. These limits are designed to provide reasonable protection against harmful interference when the equipment is operated in a commercial environment. This equipment generates, uses, and can radiate radio frequency energy and, if not installed and used in accordance with the instruction manual, may cause harmful interference to radio communications. Operation of this equipment in a residential area is likely to cause harmful interference in which case the user will be required to correct the interference at his own expense.

This transmitter must not be co-located or operated in conjunction with any other antenna or transmitter.

This equipment complies with FCC radiation exposure limits set forth for an uncontrolled environment and meets the FCC radio frequency (RF) Exposure Guidelines in Supplement C to OET65. This equipment should be installed and operated keeping the radiator at least 20 cm or more away from person's body (excluding extremities: hands, wrists, feet and ankles).

Canada

SP-5660TP contains Transmitter Module IC: 4908B-SDMGN

This device complies with Industry Canada licence-exempt RSS standard(s). Operation is subject to the following two conditions: (1) this device may not cause interference, and (2) this device must accept any interference, including interference that may cause undesired operation of the device.

Le présent appareil est conforme aux CNR d'Industrie Canada applicables aux appareils radio exempts de licence. L'exploitation est autorisée aux deux conditions suivantes : (1) l'appareil ne doit pas produire de brouillage, et (2) l'utilisateur de l'appareil doit accepter tout brouillage radioélectrique subi, même si le brouillage est susceptible d'en compromettre le fonctionnement.

This equipment complies with IC radiation exposure limits set forth for an uncontrolled environment and meets RSS-102 of the IC radio frequency (RF) Exposure rules. This equipment should be installed and operated keeping the radiator at least 20cm or more away from person's body (excluding extremities: hands, wrists, feet and ankles).

Cet équipement est conforme aux limites d'exposition aux rayonnements énoncées pour un environnement non contrôlé et respecte les règles d'exposition aux fréquences radioélectriques (RF) CNR-102 de l'IC. Cet équipement doit être installé et utilisé en gardant une distance de 20 cm ou plus entre le dispositif rayonnant et le corps (à l'exception des extrémités : mains, poignets, pieds et chevilles).

Europe



EN300 328, EN301 489, EN60950-1

SP-5660TP may be operated in Belgium, Bulgaria, Czech Republic, Denmark, Germany, Estonia, Greece, Spain, France, Ireland, Italy, Cyprus, Latvia, Lithuania, Luxembourg, Malta, Hungary, Netherlands, Austria, Poland, Portugal, Romania, Slovak Republic, Slovenia, Finland, Sweden, United Kingdom.

EN	Hereby, Pro-face, declares that this SP-5660TP is in compliance with the essential requirements and other relevant provisions of Directive 1999/5/EC.
BG	С настоящето, Pro-face, декларира, че SP-5660TP е в съответствие със съществените изисквания и другите приложими разпоредби на Директива 1999/5/EC.
CS	Pro-face tímto prohlašuje, že SP-5660TP splňuje základní požadavky a všechna příslušná ustanovení Směrnice 1999/5/ES.
DA	Undertegnede Pro-face erklærer herved, at følgende udstyr SP-5660TP overholder de væsentlige krav og øvrige relevante krav i direktiv 1999/5/EF.
DE	Hiermit erklärt Pro-face, dass sich das Gerät SP-5660TP in Übereinstimmung mit den grundlegenden Anforderungen und den übrigen einschlägigen Bestimmungen der Richtlinie 1999/5/EG befindet.
ET	Käesolevaga kinnitab Pro-face seadme SP-5660TP vastavust direktiivi 1999/5/EÜ põhinõuetele ja nimetatud direktiivist tulenevatele teistele asjakohastele sätetele.
EL	ΜΕ ΤΗΝ ΠΑΡΟΥΣΑ Ο ΚΑΤΑΣΚΕΥΑΣΤΗΣ Pro-face ΔΗΛΩΝΕΙ ΟΤΙ SP-5660TP ΣΥΜΜΟΡΦΟΝΕΤΑΙ ΠΡΟΣ ΤΙΣ ΟΥΣΙΩΔΕΙΣ ΑΠΑΙΤΗΣΕΙΣ ΚΑΙ ΤΙΣ ΛΟΙΠΕΣ ΣΧΕΤΙΚΕΣ ΔΙΑΤΑΞΕΙΣ ΤΗΣ ΟΔΗΓΙΑΣ 1999/5/ ΕΚ

ES	Por la presente, Pro-face, declara que este SP-5660TP cumple con los requisitos esenciales y otras exigencias relevantes de la Directiva 1999/5/EC.
FR	Par la présente, Pro-face déclare que l'appareil SP-5660TP est conforme aux exigences essentielles et aux autres dispositions pertinentes de la directive 1999/5/CE.
IT	Con la presente Pro-face dichiara che questo SP-5660TP è conforme ai requisiti essenziali ed alle altre disposizioni pertinenti stabilite dalla direttiva 1999/5/CE.
LV	Ar šo Pro-face deklarē, ka SP-5660TP atbilst Direktīvas 1999/5/EK būtiskajām prasībām un citiem ar to saistītajiem noteikumiem.
LT	Šiuo Pro-face deklaruoja, kad šis SP-5660TP atitinka esminius reikalavimus ir kitas 1999/5/EB Direktyvos nuostatas
HU	A Pro-face ezzennel kijelenti, hogy a SP-5660TP típusú beren-dezés teljesíti az alapvető követelményeket és más 1999/5/EK irányelvben meghatározott vonatkozó rendelkezéseket.
NL	Hierbij verklaart Pro-face dat het toestel I SP-5660TP in overeenstemming is met de essentiële eisen en de andere relevante bepalingen van richtlijn 1999/5/EG.
PL	Niniejszym Pro-face deklaruje że SP-5660TP jest zgodny z zasadniczymi wymaganiami i innymi właściwymi postanowieniami Dyrektywy 1999/5/EC.
PT	Eu, Pro-face, declaro que o SP-5660TP cumpre os requisitos essenciais e outras provisões relevantes da Directiva 1999/5/EC.

RO	Prin prezenta, Pro-face, declară că aparatul SP-5660TP este în conformitate cu cerințele esențiale și cu alte prevederi pertinente ale Directivei 1999/5/CE.
SK	Pro-face týmto vyhlasuje, že SP-5660TP spĺňa základné požiadavky a všetky príslušné ustanovenia Smernice 1999/5/ES.
SL	Pro-face izjavlja, da je ta SP-5660TP v skladu z bistvenimi zahtevami in drugimi relevantnimi določili direktive 1999/5/ES.
FI	Pro-face vakuuttaa täten että SP-5660TP tyyppinen laite on direktiivin 1999/5/EY oleellisten vaatimusten ja sitä koskevien direktiivin muiden ehtojen mukainen.
SV	Denna utrustning är i överensstämmelse med de väsentliga kraven och andra relevanta bestämmelser i direktiv 1999/5/EC.

China

1. SP-5660TP 的使用方法

- 使用频率：2.4 - 2.4835 GHz
等效全向辐射功率(EIRP)：
天线增益 < 10dBi时：≤100 mW 或≤20 dBm
- 最大功率谱密度：
天线增益 < 10dBi时：≤10 dBm / MHz(EIRP)
- 载频容限：20 ppm
- 带外发射功率(在2.4-2.4835GHz频段以外) ≤-80 dBm / Hz (EIRP)
- 杂散发射(辐射)功率(对应载波±2.5倍信道带宽以外)：
≤-36 dBm / 100 kHz (30 - 1000 MHz)
≤-33 dBm / 100 kHz (2.4 - 2.4835 GHz)
≤-40 dBm / 1 MHz (3.4 - 3.53 GHz)
≤-40 dBm / 1 MHz (5.725 - 5.85 GHz)
≤-30 dBm / 1 MHz (其它1 - 12.75 GHz)

2.

不得擅自更改发射频率、加大发射功率(包括额外加装射频功率放大器)，
不得擅自外接天线或改用其它发射天线；

3.使用时不得对各种合法的无线电通信业务产生有害干扰；一旦发现有干扰现象时，应立即停止使用，并采取措施消除干扰后方可继续使用；

4.使用微功率无线电设备，必须忍受各种无线电业务的干扰或工业、科学及医疗应用设备的辐射干扰；

5.不得在飞机和机场附近使用。

Korea

해당 무선설비는 운용 중 전파혼신 가능성이 있음

사용자안내문

기종별	사용자안내문
A급 기기 (업무용 방송통신기자재)	이 기기는 업무용(A급) 전자파적합기기로서 판매자 또는 사용자는 이 점을 주의하시기 바라며, 가정외의 지역에서 사용하는 것을 목적으로 합니다.

해당 무선설비는 전파혼신 가능성이 있으므로 인명안전과 관련된 서비스는 할 수 없습니다

Taiwan

低功率電波輻射性電機管理辦法

第十二條

經型式認證合格之低功率射頻電機，非經許可，公司、商號或使用者均不得擅自變更頻率、加大功率或變更原設計之特性及功能。

第十四條

低功率射頻電機之使用不得影響飛航安全及干擾合法通信；經發現有干擾現象時，應立即停用，並改善至無干擾時方得繼續使用。前項合法通信，指依電信法規定作業之無線電通信。低功率射頻電機須忍受合法通信或工業、科學及醫療用電波輻射性電機設備之干擾。

Japan

SP-5660TP には、認証済み無線機器を搭載しています。

